



US00D737872S

(12) **United States Design Patent**
Johansson

(10) **Patent No.:** **US D737,872 S**
(45) **Date of Patent:** **** Sep. 1, 2015**

(54) **CRUSHER TANK**

(56) **References Cited**

(71) Applicant: **SANDVIK INTELLECTUAL
PROPERTY AB**, Sandviken (SE)

U.S. PATENT DOCUMENTS

(72) Inventor: **Jan Johansson**, Arlov (SE)

D211,723	S	*	7/1968	Vroman et al.	D23/202
D258,737	S	*	3/1981	Schmidt	D15/123
D283,623	S	*	4/1986	Labarge et al.	D15/123
5,012,949	A	*	5/1991	McGarvey et al.	220/560.01
D338,900	S	*	8/1993	Balbas et al.	D15/123
D413,339	S	*	8/1999	Wales, Jr.	D15/123
D447,535	S	*	9/2001	Oakley	D23/202
D604,343	S	*	11/2009	Murakami et al.	D15/123
D654,556	S	*	2/2012	McIntosh	D23/202
D656,971	S	*	4/2012	Young et al.	D15/123

(73) Assignee: **SANDVIK INTELLECTUAL
PROPERTY AB**, Sandviken (SE)

(**) Term: **14 Years**

* cited by examiner

(21) Appl. No.: **29/485,546**

Primary Examiner — Robin V Webster

(22) Filed: **Mar. 19, 2014**

(74) *Attorney, Agent, or Firm* — Corinne R Gorski

(30) **Foreign Application Priority Data**

(57) **CLAIM**

The ornamental design for a crusher tank, as shown.

Sep. 20, 2013 (EM) 001384416-0001

DESCRIPTION

(51) **LOC (10) Cl.** **15-09**

FIG. 1 is a top perspective of a tank for a crusher,
FIG. 2 is a front view of the crusher tank of FIG. 1,
FIG. 3 is a back view of the crusher tank of FIG. 1,
FIG. 4 is a right side view of the crusher tank of FIG. 1,
FIG. 5 is a left side view of the crusher tank of FIG. 1,
FIG. 6 is a top view of the crusher tank of FIG. 1; and,
FIG. 7 is a bottom view of the crusher tank of FIG. 1.

(52) **U.S. Cl.**

USPC **D15/123; D23/202**

(58) **Field of Classification Search**

USPC D23/202-205; D15/33, 123; 220/565,
220/587, 567.1, 562; 72/455, 465

See application file for complete search history.

1 Claim, 7 Drawing Sheets

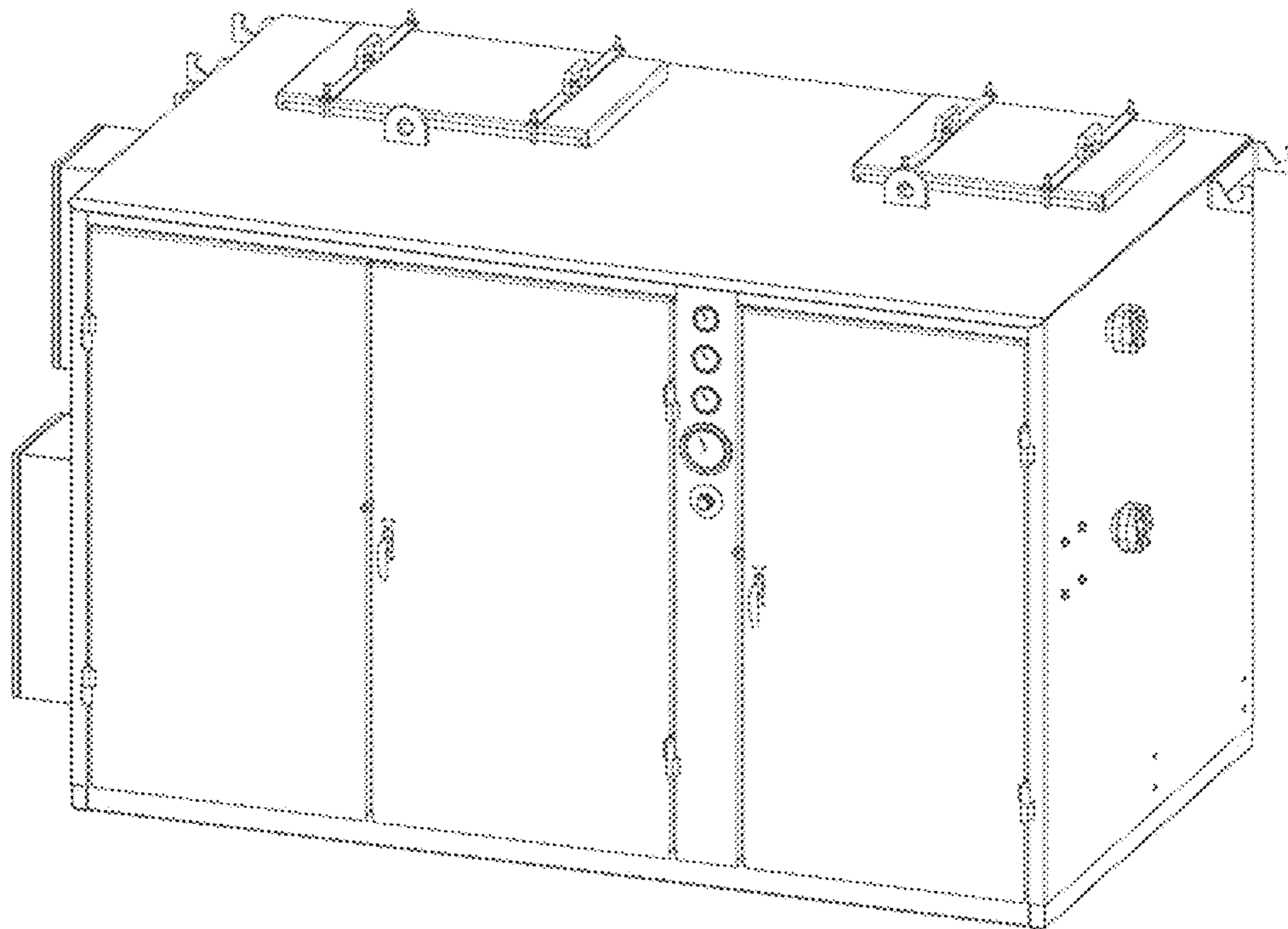

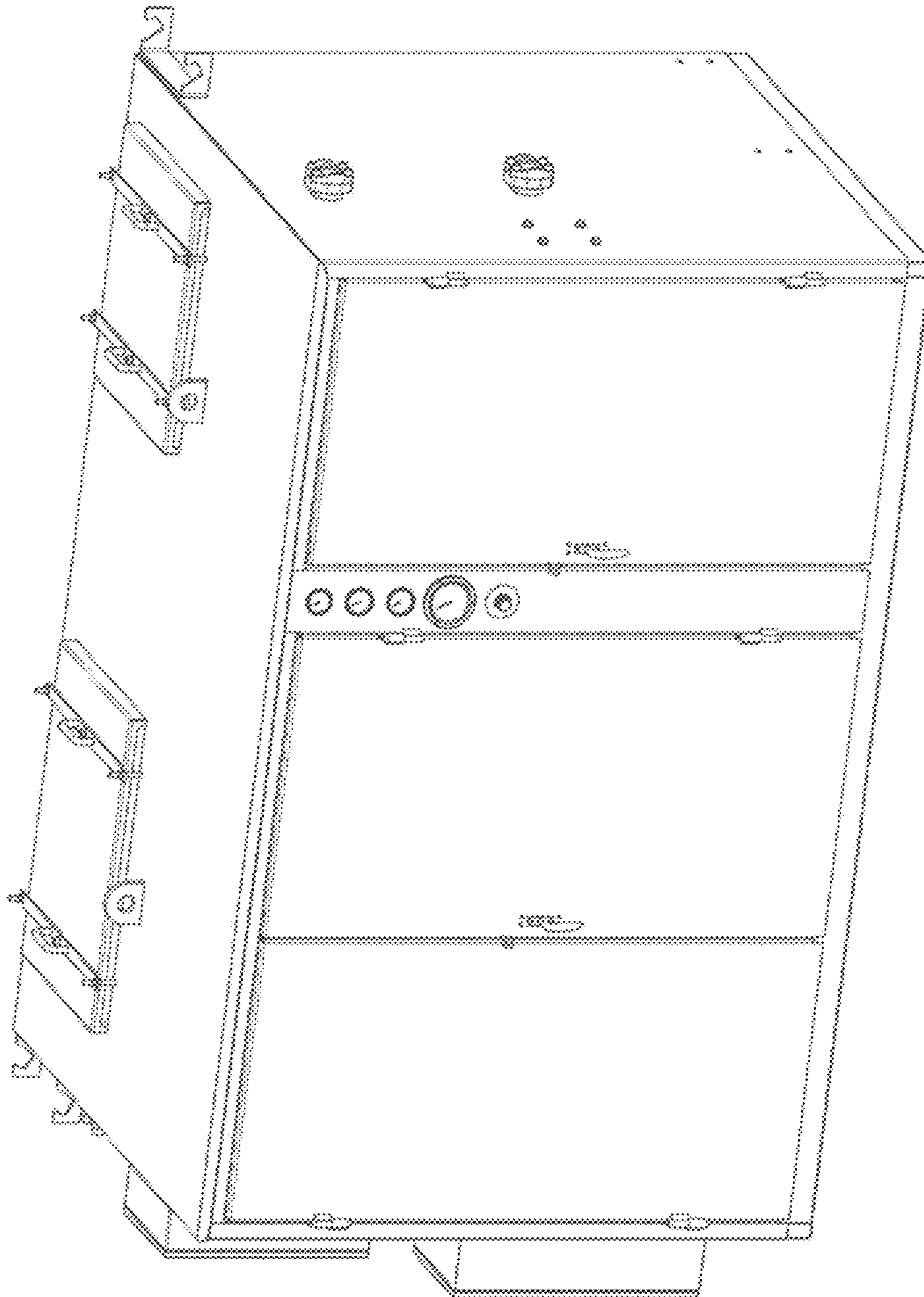

Fig. 1

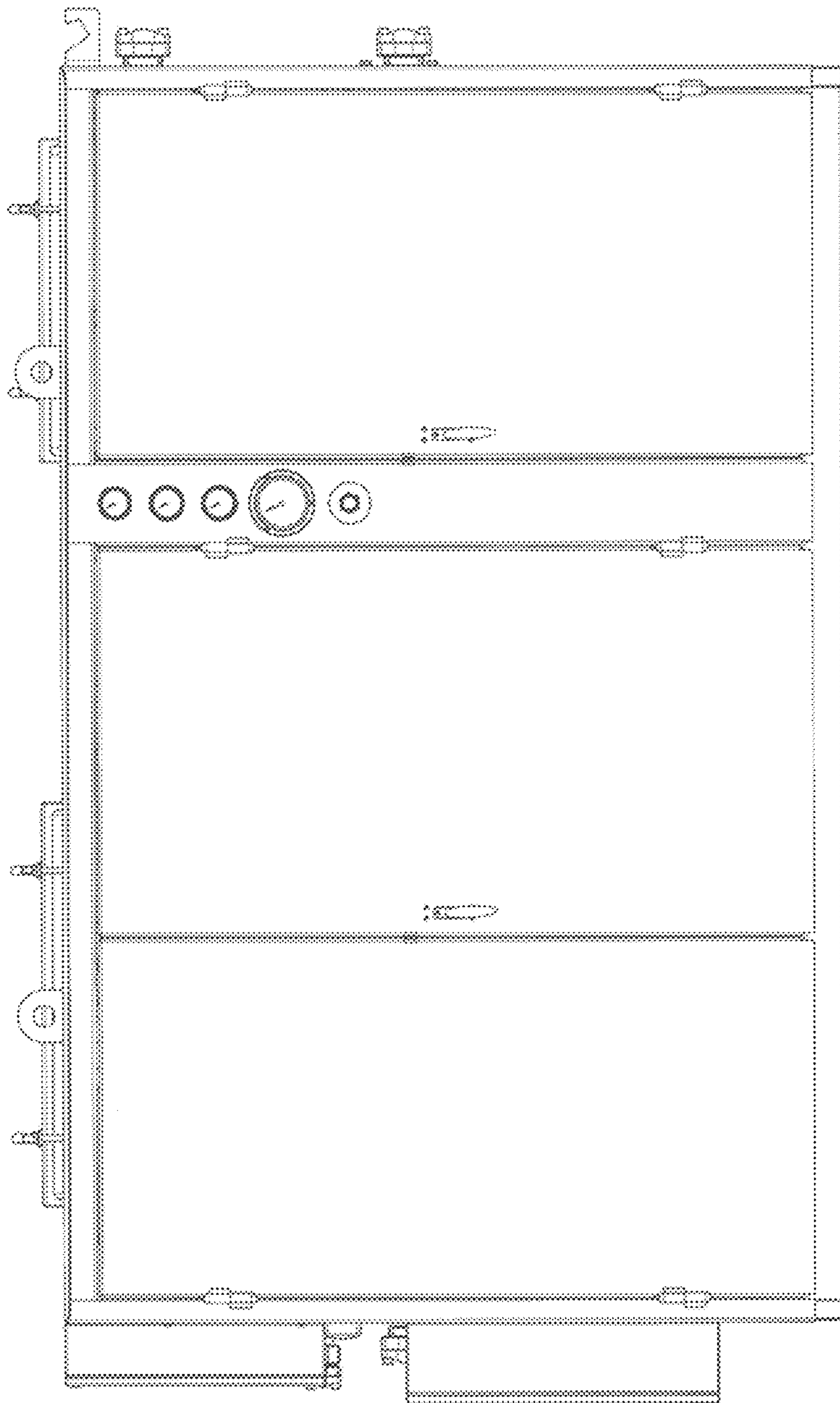

FIG. 2

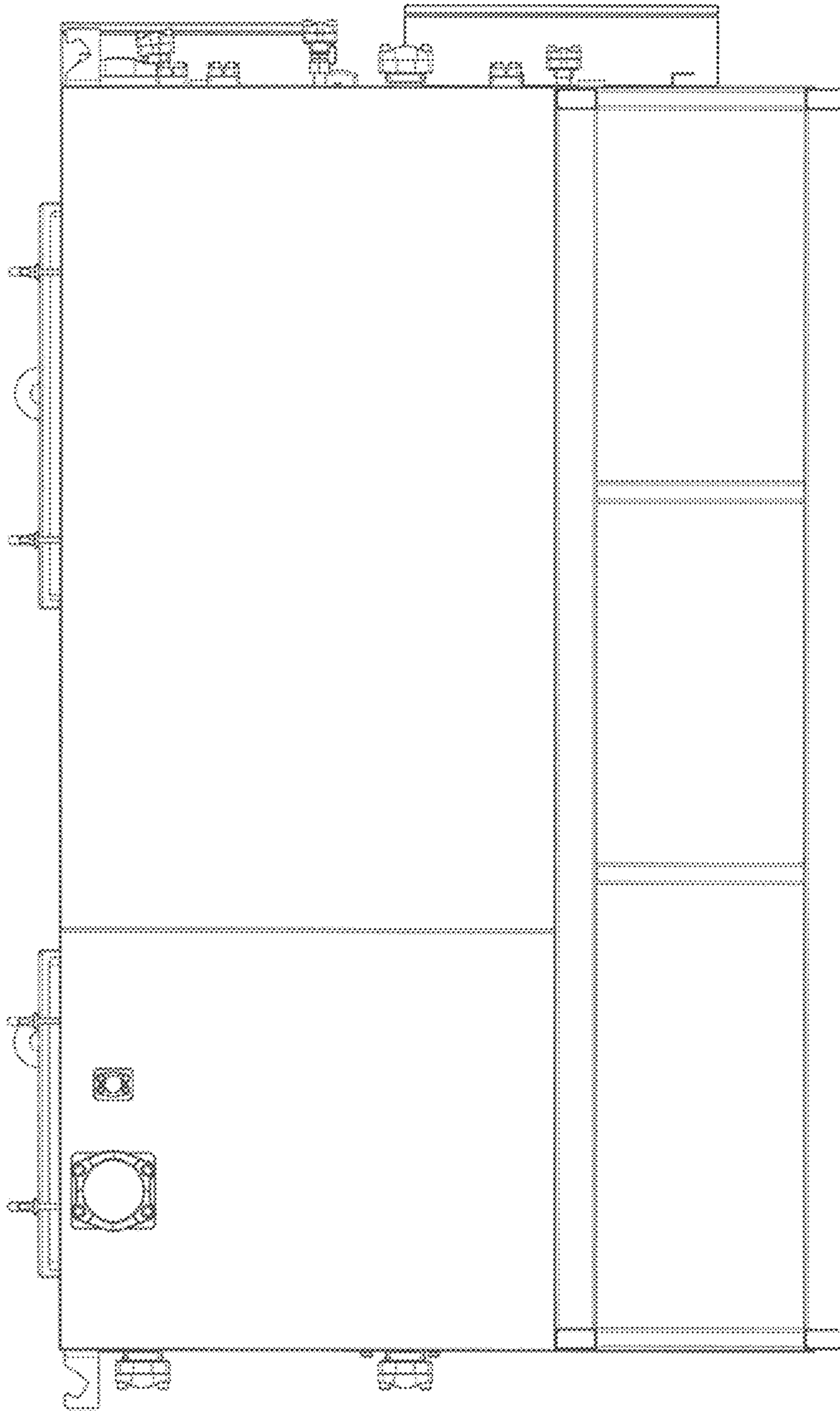

Fig. 3

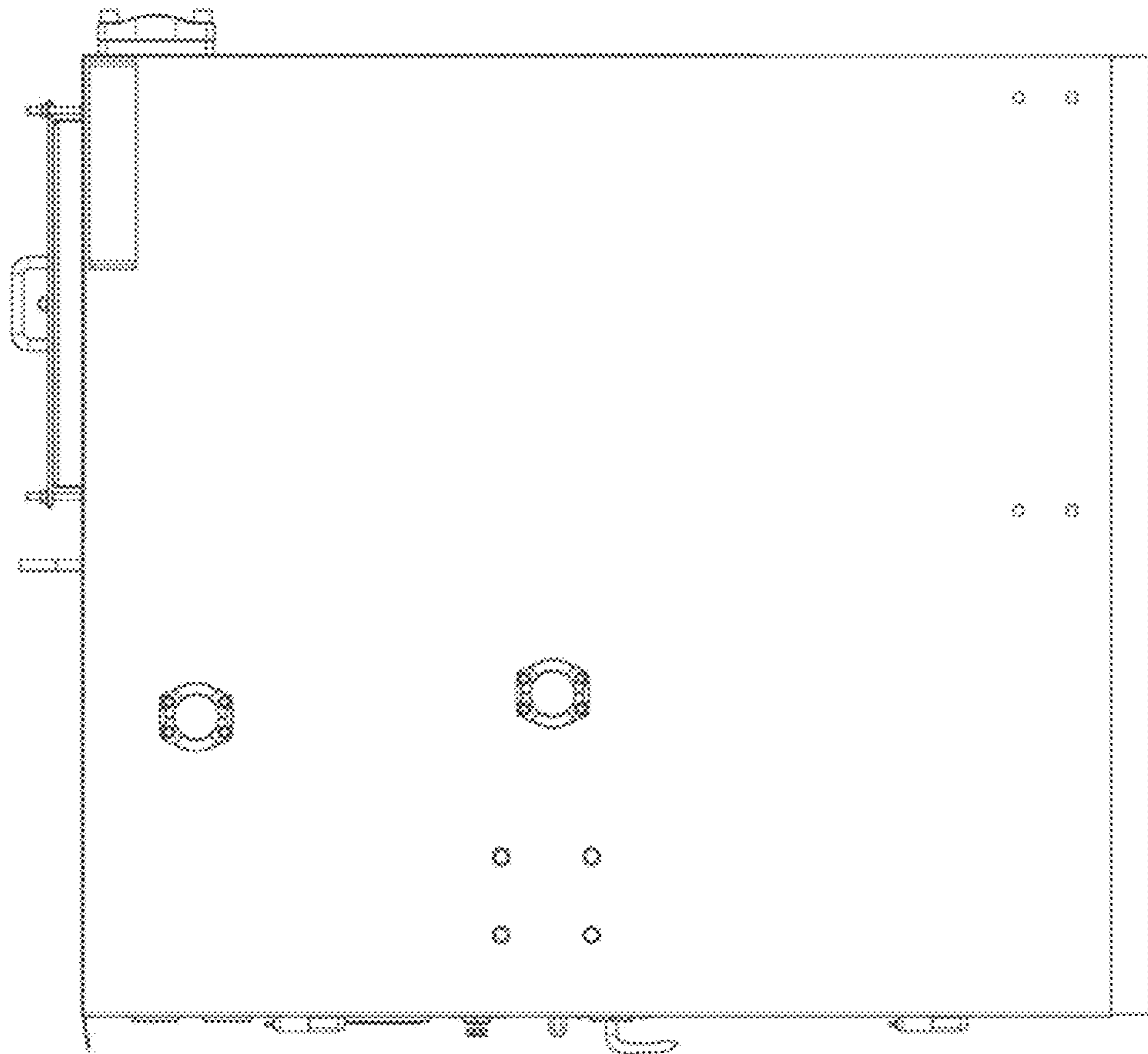

Fig. 4

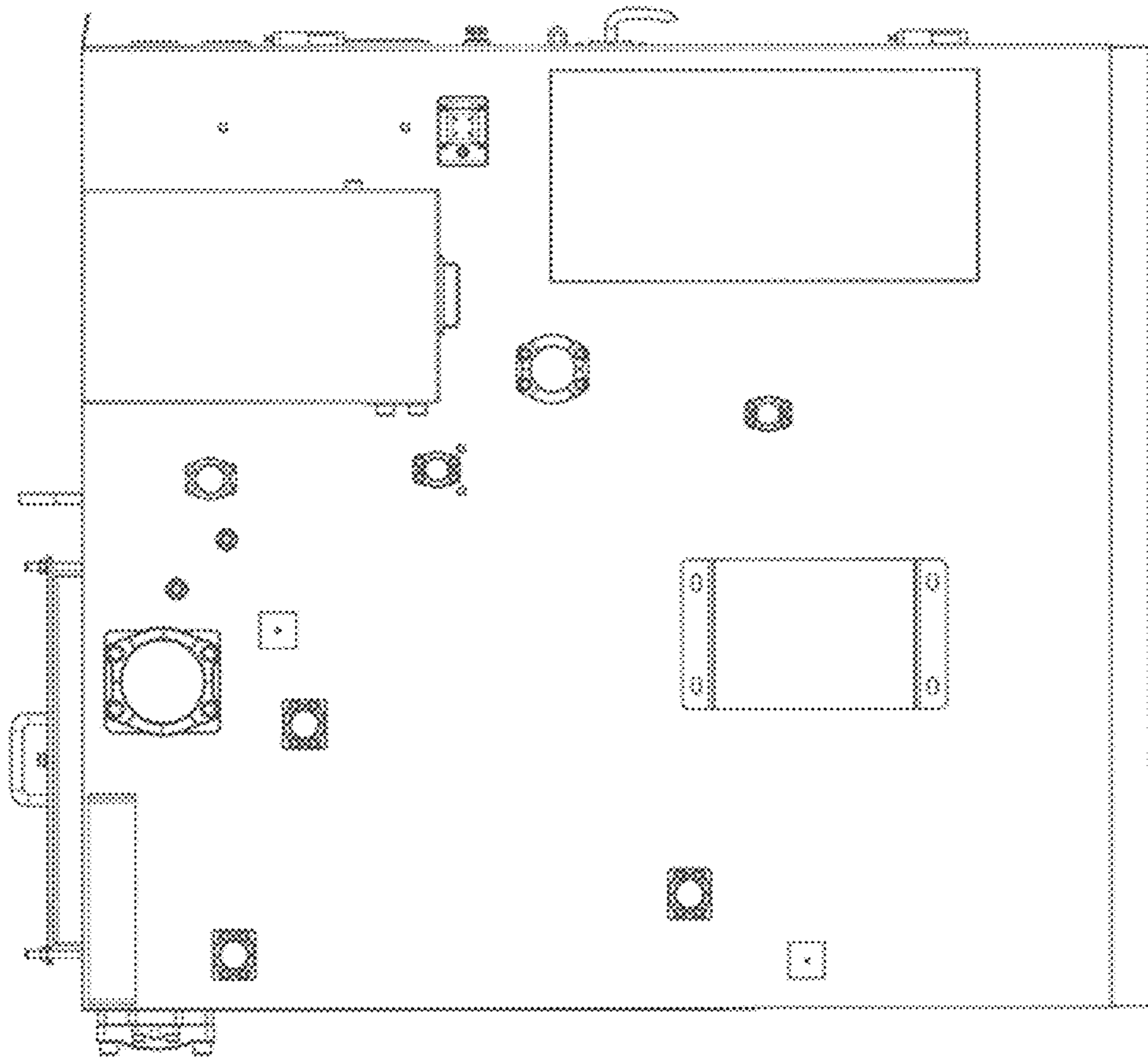

Fig. 5

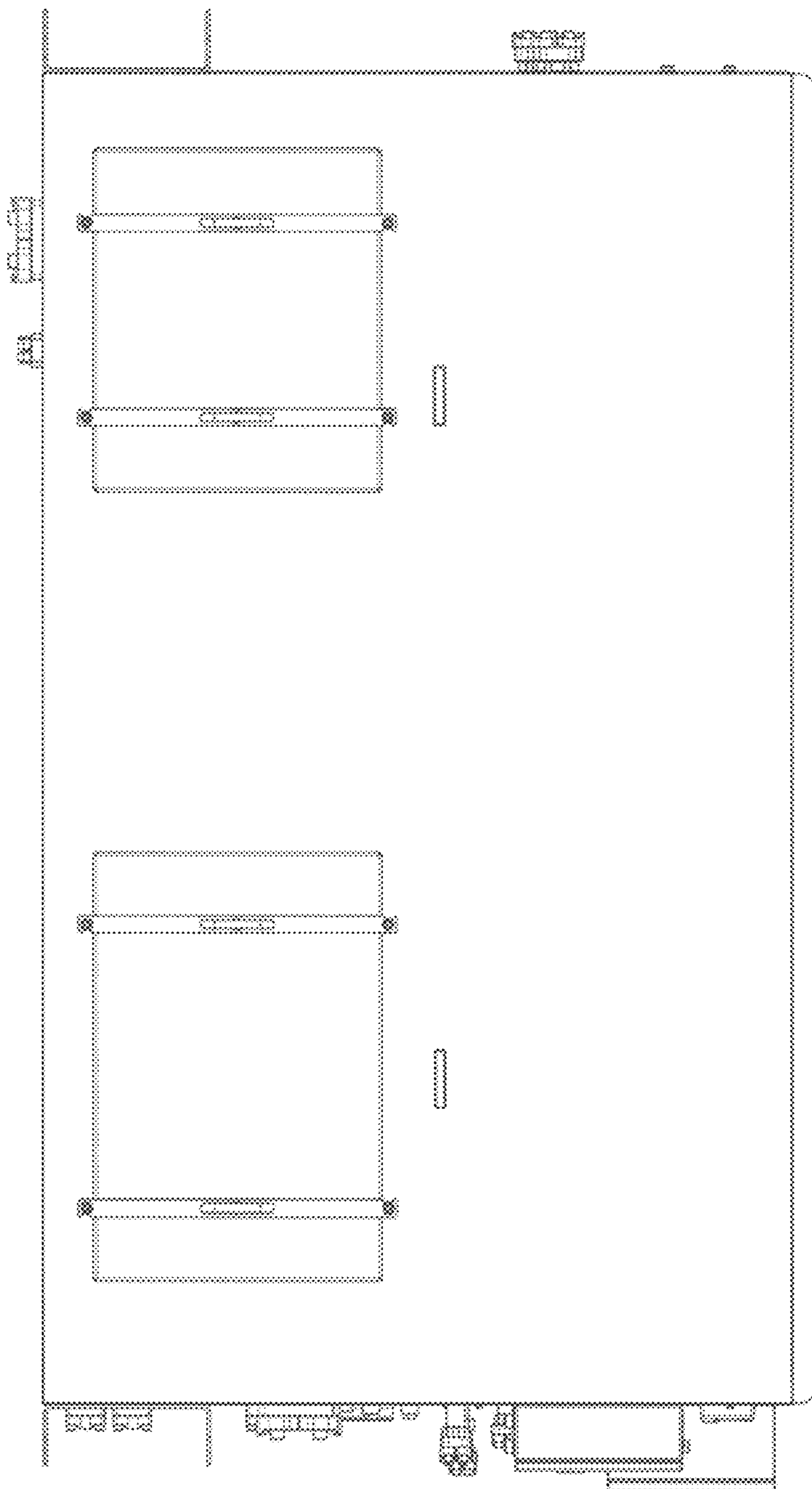

Fig. 6

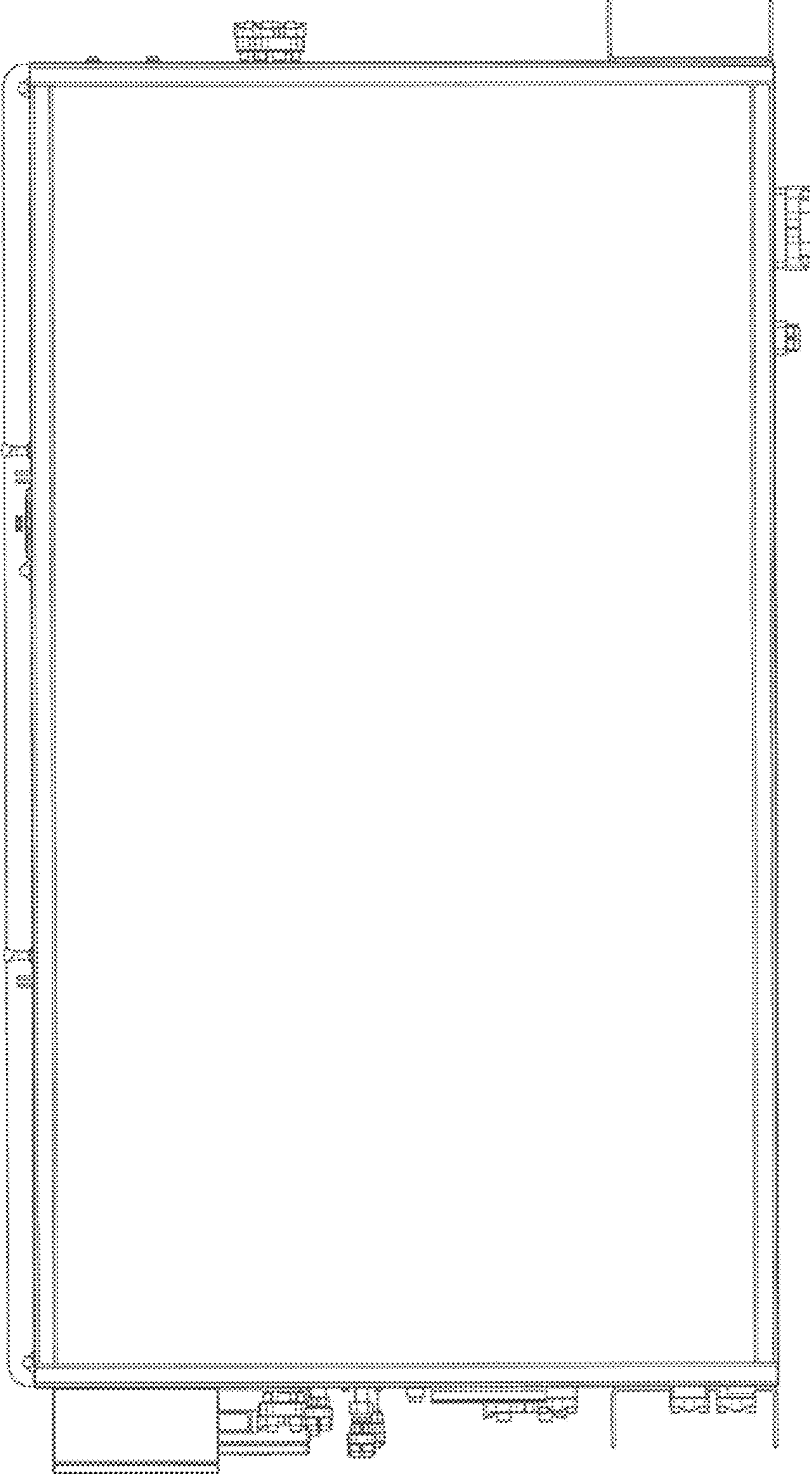

Fig. 7