



US00D737828S

(12) **United States Design Patent**
Albano

(10) **Patent No.:** **US D737,828 S**
(45) **Date of Patent:** **** Sep. 1, 2015**

(54) **PERSONAL ORGANIZER FOLDER**

(71) Applicant: **Stephen J. Albano**, Webster, NY (US)

(72) Inventor: **Stephen J. Albano**, Webster, NY (US)

(**) Term: **14 Years**

(21) Appl. No.: **29/483,053**

(22) Filed: **Feb. 25, 2014**

(51) **LOC (10) Cl.** **14-02**

(52) **U.S. Cl.**
USPC **D14/440**; D19/26

(58) **Field of Classification Search**
USPC D19/26, 28, 32, 192, 199, 202, 100;
D14/217, 299, 440; D3/201, 303, 247,
D3/249, 248, 269, 300, 225, 226; 190/102,
190/127, 901, 902; 281/15.1, 19.1, 29, 20,
281/31, 51; 206/701, 527
CPC A45C 11/00; A45C 2011/003; A45C
2013/025; B42D 3/12; G06F 2200/1633
See application file for complete search history.

(56) **References Cited**

U.S. PATENT DOCUMENTS

4,470,620	A *	9/1984	Gerch	281/31
D330,115	S *	10/1992	O'Brien	D3/249
5,348,347	A *	9/1994	Shink	281/31
D352,604	S *	11/1994	Johnson	D3/303
D646,892	S *	10/2011	Littleton	D3/299
D666,804	S *	9/2012	Rogers	D3/201
D669,121	S *	10/2012	May	D19/26
D669,271	S *	10/2012	May	D3/303
D669,480	S *	10/2012	Piedra et al.	D14/440
D684,978	S *	6/2013	Phillips et al.	D14/440
D692,886	S *	11/2013	Bates et al.	D14/392
8,644,893	B2 *	2/2014	Liang	455/575.1
D706,783	S *	6/2014	Almodova	D14/440
8,763,795	B1 *	7/2014	Oten et al.	206/45.23
8,899,415	B2 *	12/2014	McCosh et al.	206/320
2010/0149739	A1 *	6/2010	Mish et al.	361/679.02

2011/0204758	A1 *	8/2011	Loncar et al.	312/223.1
2011/0233912	A1 *	9/2011	Reising	281/20
2012/0153116	A1 *	6/2012	Harrison	248/460
2013/0015088	A1 *	1/2013	Wu	206/320

(Continued)

FOREIGN PATENT DOCUMENTS

CH	705314	A2 *	1/2013	B42D 3/12
DE	202011103510	U1 *	11/2011	A45C 11/00
GB	2477321	B *	6/2014	B42D 3/12

OTHER PUBLICATIONS

Touchfire iPad Keyboard; Touchfire Screen-Top iPad Keyboard/How it Works; <http://www.touchfire.com/how-it-works/>; Dec. 13, 2012.

(Continued)

Primary Examiner — Sheryl Lane

Assistant Examiner — Ieisha Price

(74) *Attorney, Agent, or Firm* — Woods Oviatt Gilman LLP; Katherine H. McGuire, Esq.

(57) **CLAIM**

The ornamental design for a personal organizer folder, as shown and described.

DESCRIPTION

FIG. 1 is a top plan view of a personal organizer folder in the fully open position in accordance with the present invention; FIG. 2 is a bottom plan view thereof; FIG. 3 is a front elevational view thereof; FIG. 4 is a rear elevational view thereof; FIG. 5 is a side elevational view thereof, with the personal organizer folder facing downward; FIG. 6 is a side elevational view thereof, with the personal organizer folder facing upward; and, FIG. 7 is a perspective view thereof, showing the personal organizer folder in an open, standing position. The broken lines in the drawings represent stitching.

1 Claim, 5 Drawing Sheets

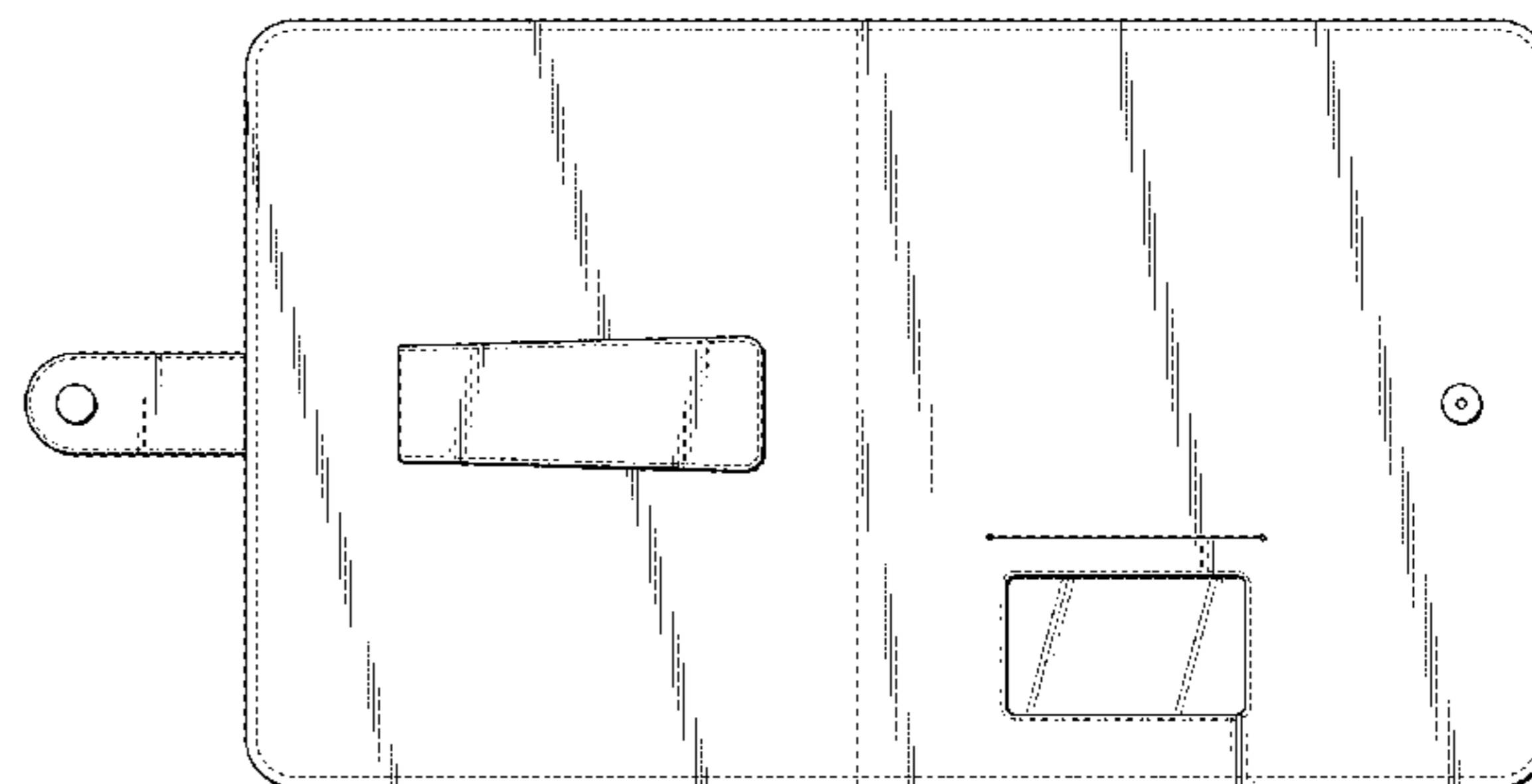
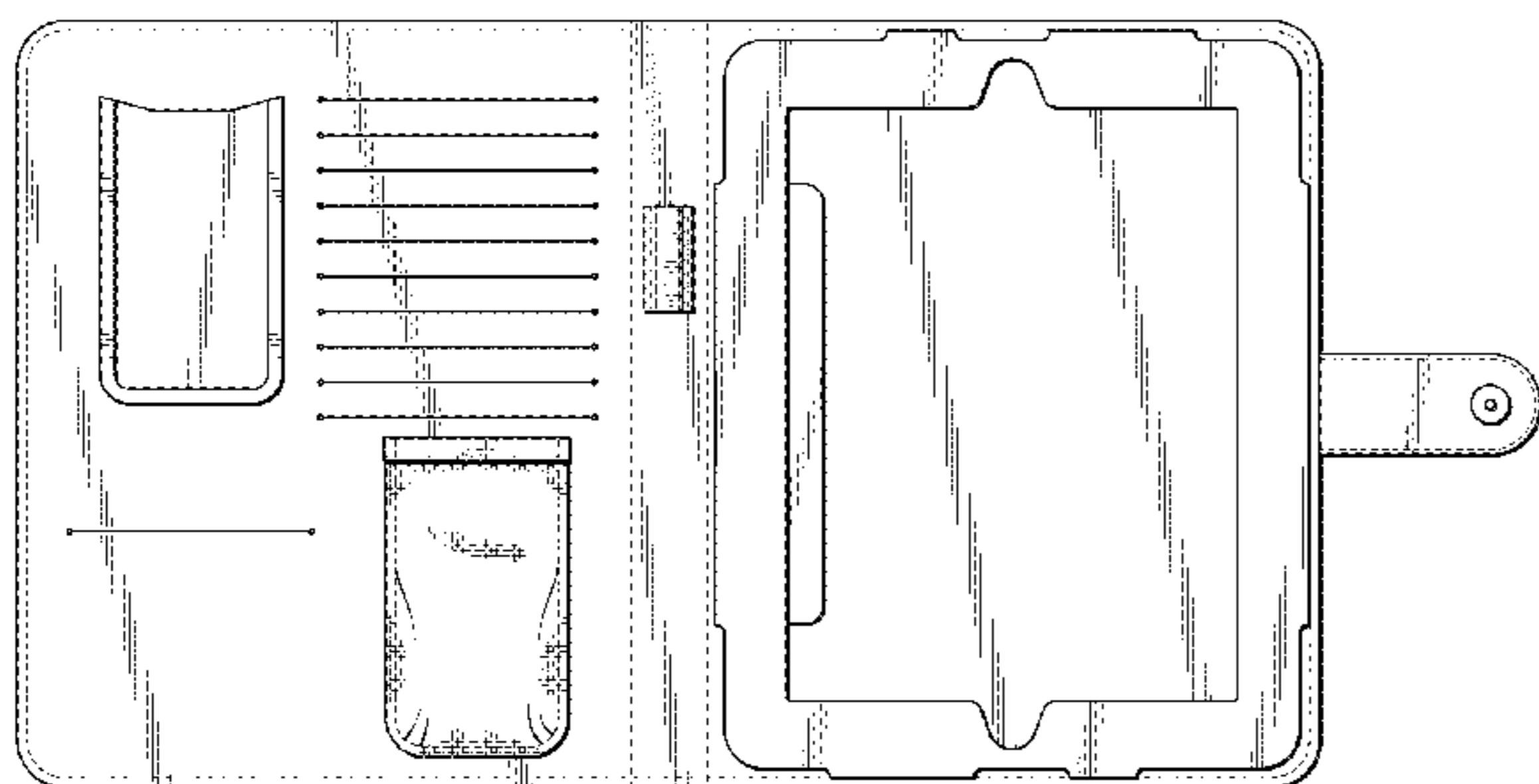

(56)

References Cited

OTHER PUBLICATIONS

U.S. PATENT DOCUMENTS

2013/0043778	A1 *	2/2013	Bennett, Jr.	312/326
2013/0083953	A1 *	4/2013	Chang	381/333
2013/0264241	A1 *	10/2013	McCosh et al.	206/472
2014/0000844	A1 *	1/2014	Chandaria	165/80.2
2014/0202888	A1 *	7/2014	Lieblein	206/45.23
2014/0224676	A1 *	8/2014	Ashley et al.	206/37
2014/0274215	A1 *	9/2014	Del Toro et al.	455/566

Red Tree Gear; TacType—Touch-type on your iPad Keyboard; <http://www.redtreegear.com/tactype/>; Oct. 5, 2013.

Apple; Case Design Guidelines for Apple Devices, Release R6; Oct. 22, 2013.

* cited by examiner

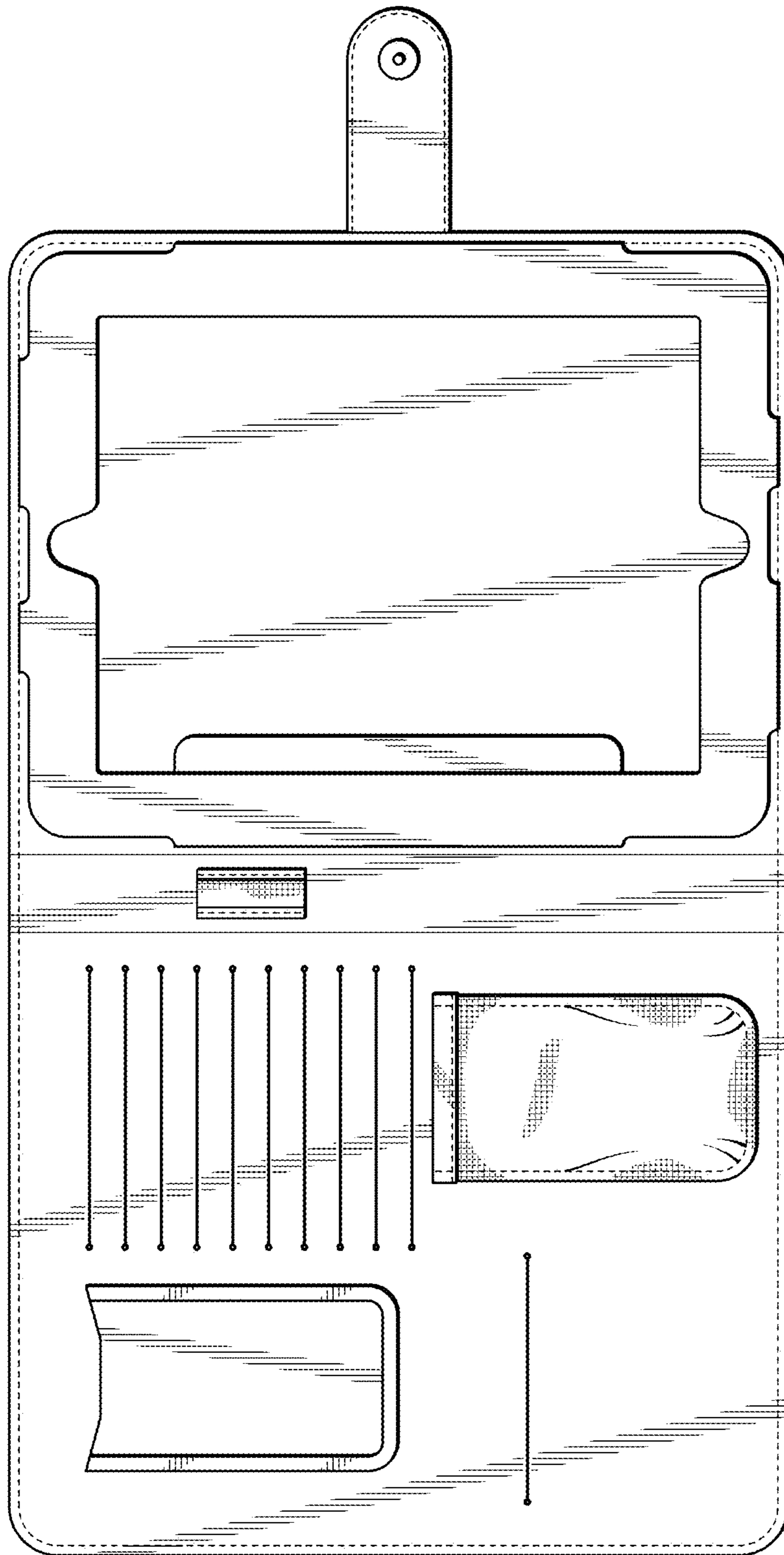

FIG. 1

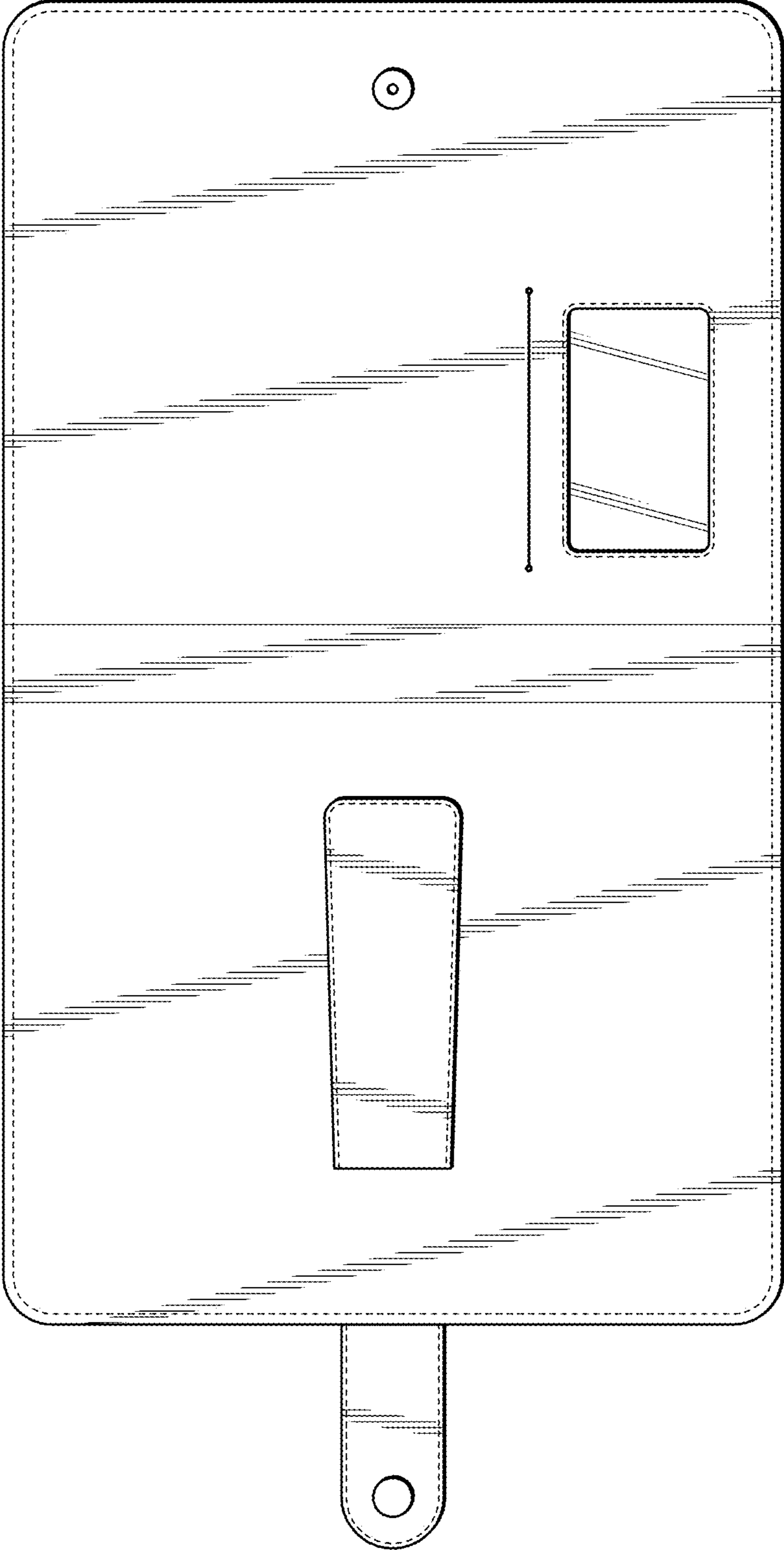

FIG. 2

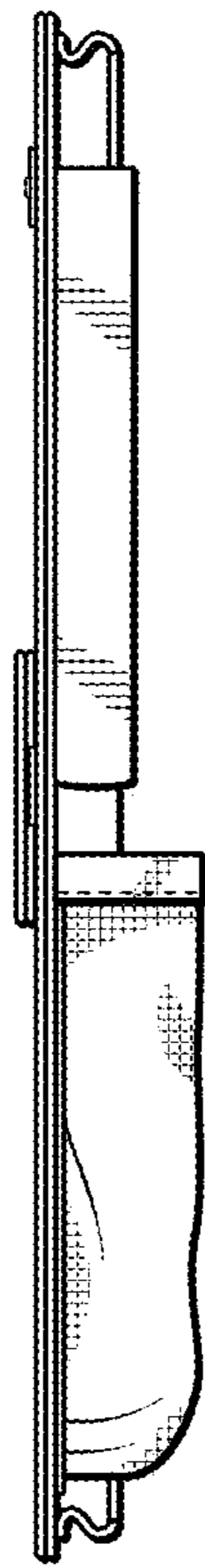

FIG. 3

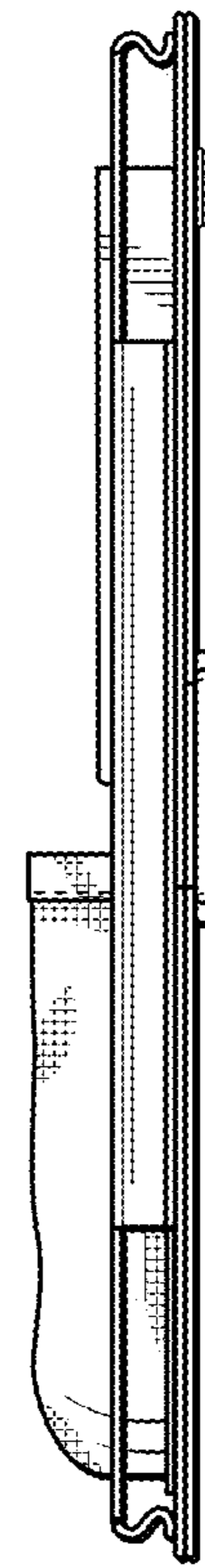

FIG. 4

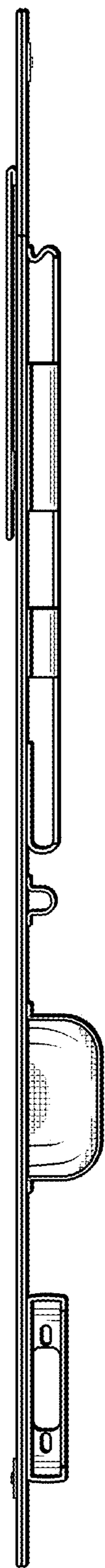

FIG. 5

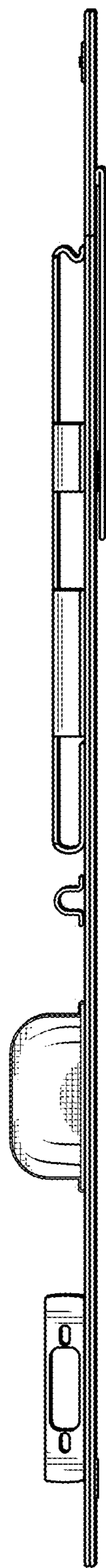

FIG. 6

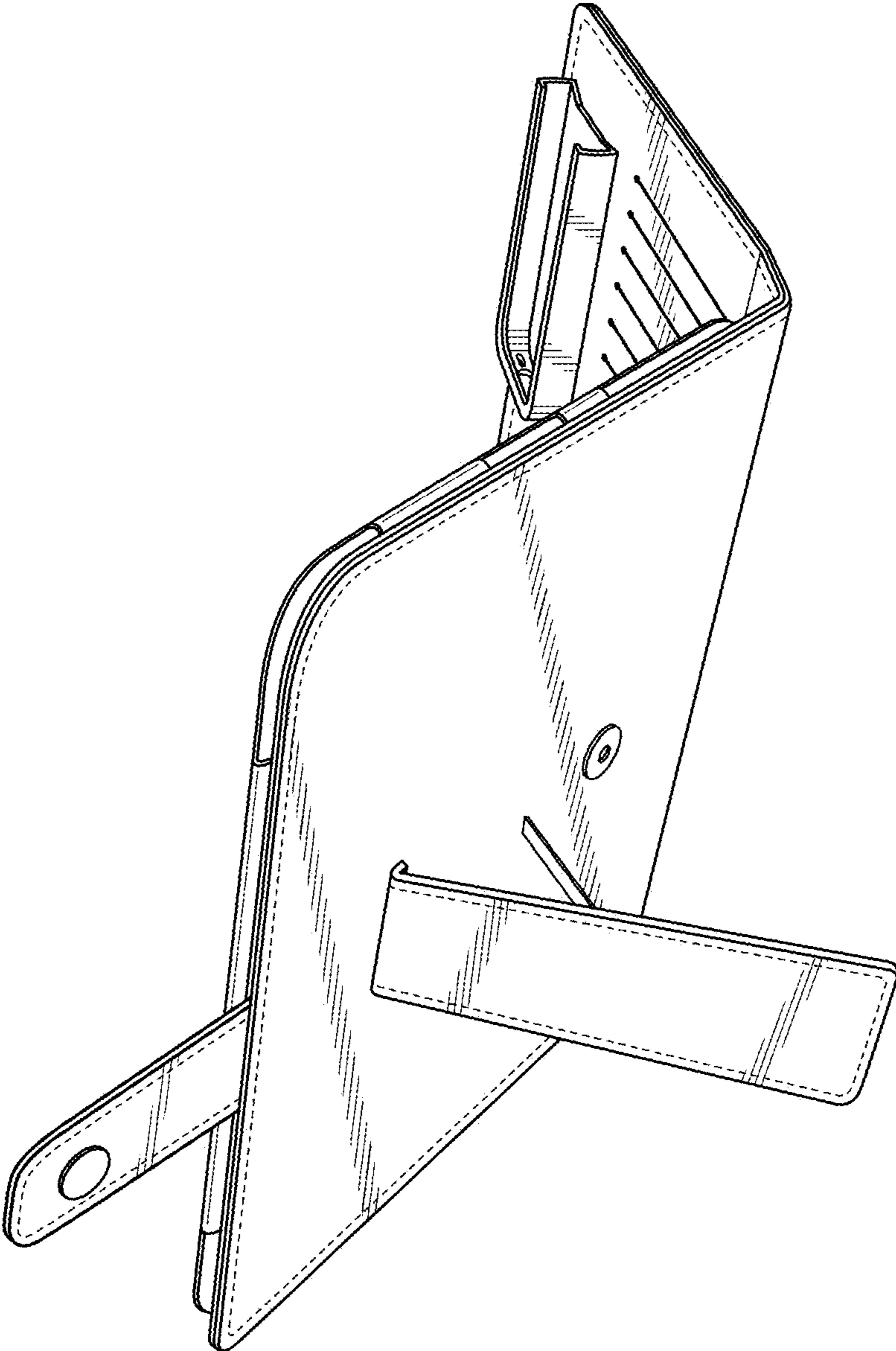

FIG. 7