



US00D737818S

(12) **United States Design Patent**
Peng et al.

(10) **Patent No.:** **US D737,818 S**

(45) **Date of Patent:** **** Sep. 1, 2015**

(54) **DATA STORAGE DEVICE**

Primary Examiner — Karen E Kearney

(71) Applicant: **Western Digital Technologies, Inc.**,
Irvine, CA (US)

(57) **CLAIM**
The ornamental design for a data storage device, as shown and described.

(72) Inventors: **Steven T. Peng**, Irvine, CA (US);
Takashi Kono, Monterey Park, CA (US)

DESCRIPTION

(73) Assignee: **Western Digital Technologies, Inc.**,
Irvine, CA (US)

FIG. 1 is a top, front and side perspective view of a first embodiment of a data storage device embodying the new design.

(**) Term: **14 Years**

FIG. 2 is a first side view thereof.

(21) Appl. No.: **29/455,869**

FIG. 3 is a second side view thereof.

(22) Filed: **May 24, 2013**

FIG. 4 is a front view thereof.

(51) **LOC (10) Cl.** **14-02**

FIG. 5 is a back view thereof.

(52) **U.S. Cl.**

FIG. 6 is a top view thereof.

USPC **D14/365**

FIG. 7 is a bottom view thereof.

(58) **Field of Classification Search**

FIG. 8 is a top, front and side perspective view of a second embodiment of a data storage device embodying the new design.

USPC D14/300–302, 314, 348–370, 383–385,

FIG. 9 is a first side view thereof.

D14/435, 496, 125, 135, 155, 240–242,

FIG. 10 is a second side view thereof.

D14/299; D3/273; D9/432; D10/65, 75, 78;

FIG. 11 is a front view thereof.

D13/103, 119, 162, 184, 199

FIG. 12 is a back view thereof.

CPC ... G11B 33/027; G11B 33/122; G11B 33/124

FIG. 13 is a top view thereof.

See application file for complete search history.

FIG. 14 is a bottom view thereof.

FIG. 15 is a top, front and side perspective view of a third embodiment of a data storage device embodying the new design.

(56) **References Cited**

FIG. 16 is a first side view thereof.

U.S. PATENT DOCUMENTS

FIG. 17 is a second side view thereof.

D305,753 S * 1/1990 Hoshino D14/351

FIG. 18 is a front view thereof.

D314,959 S * 2/1991 Kohno D14/135

FIG. 19 is a back view thereof.

D336,289 S * 6/1993 Hill D14/365

FIG. 20 is a top view thereof; and,

D340,234 S * 10/1993 Katayama D14/368

FIG. 21 is a bottom view thereof.

(Continued)

Broken lines are used to illustrate features of the data storage device which form no part of the claimed design.

OTHER PUBLICATIONS

The wavy broken lines in the drawings indicate that the appearance of any portion of the data storage device between the wavy broken lines forms no part of the claimed design.

Western Digital My Book™: Photos, [online], [retrieved on Nov. 14, 2006]. Retrieved from the Internet <URL: <http://www.wdmybook.com/en/photos/>>.*

(Continued)

1 Claim, 12 Drawing Sheets

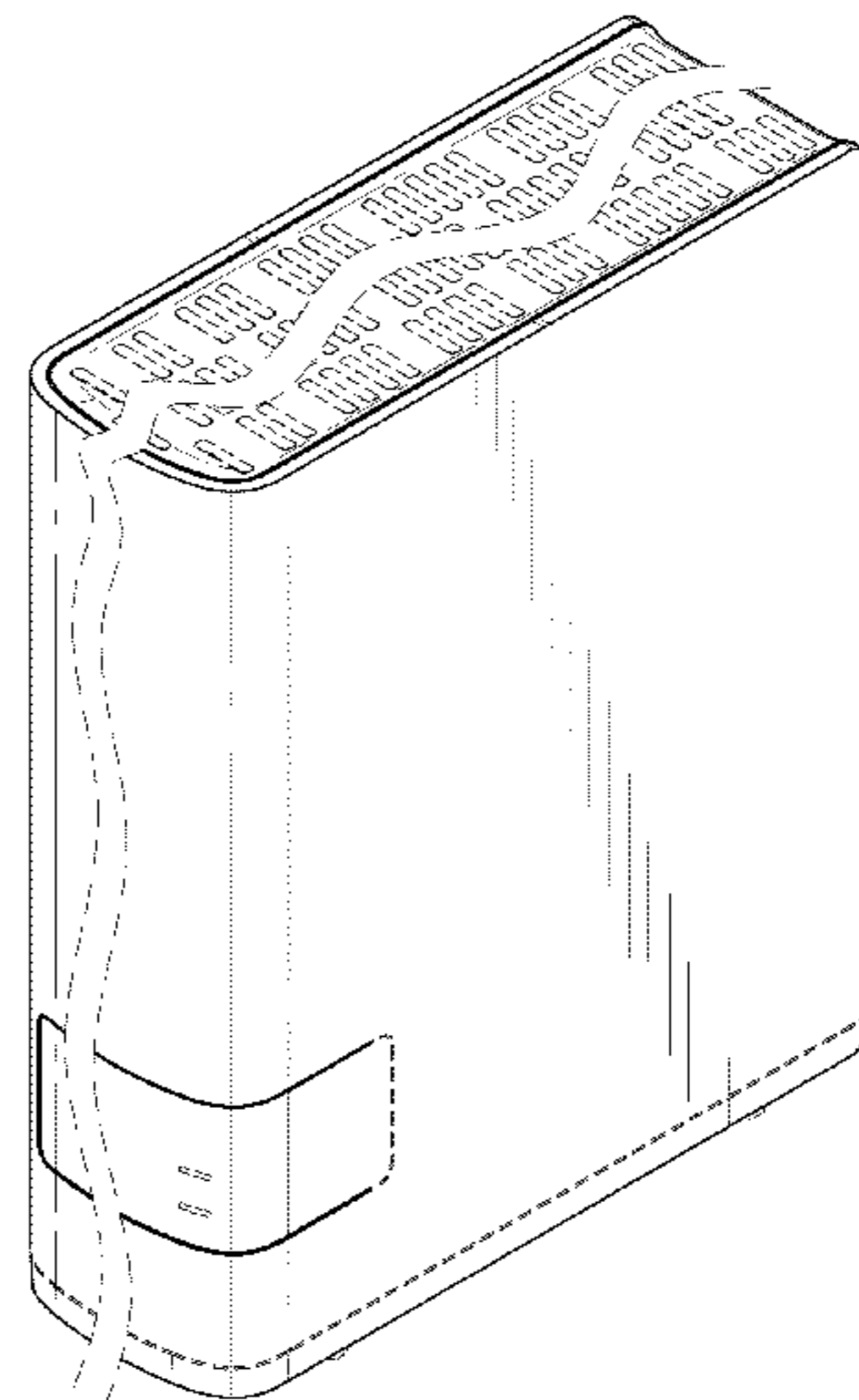
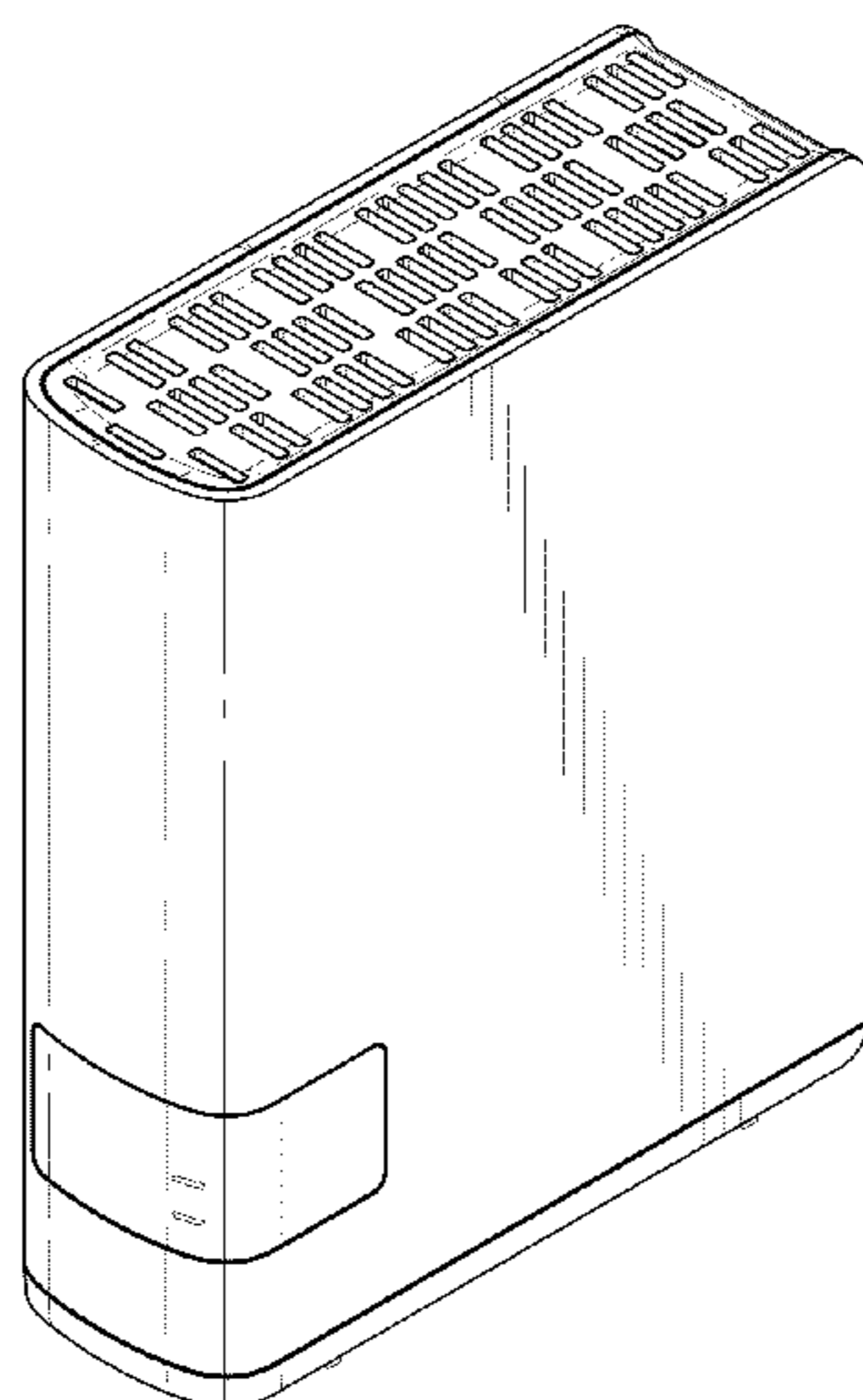

(56)

References Cited

U.S. PATENT DOCUMENTS

D345,345 S * 3/1994 Falkenberg et al. D14/354
D360,405 S * 7/1995 Hill et al. D14/351
D401,913 S * 12/1998 Beck et al. D13/184
D514,563 S * 2/2006 Kuramashi et al. D14/358
D541,266 S * 4/2007 Wu D14/300
D542,289 S * 5/2007 Diebel D14/356
D545,308 S * 6/2007 Lauffer et al. D14/349
D568,276 S * 5/2008 Ikeda et al. D14/365
D641,753 S * 7/2011 Obata D14/356

D651,994 S * 1/2012 Lundbom et al. D14/125
8,164,849 B1 * 4/2012 Szeremeta et al. 360/97.19

OTHER PUBLICATIONS

3.5" Hard Disk Player (OTG), Web Archive [online] Dec. 13, 2006
[retrieved on Dec. 13, 2006]. Retrieved from the Internet <URL:
[http://web.archive.org/web/20061213155301/http://foryougroup.en.alibaba.com . . . 8919/50221727/3_5_Hard_Disk_Player/3_5_Hard_Disk_Player_OTG_/showimg.html](http://web.archive.org/web/20061213155301/http://foryougroup.en.alibaba.com...8919/50221727/3_5_Hard_Disk_Player/3_5_Hard_Disk_Player_OTG_/showimg.html)>.*

* cited by examiner

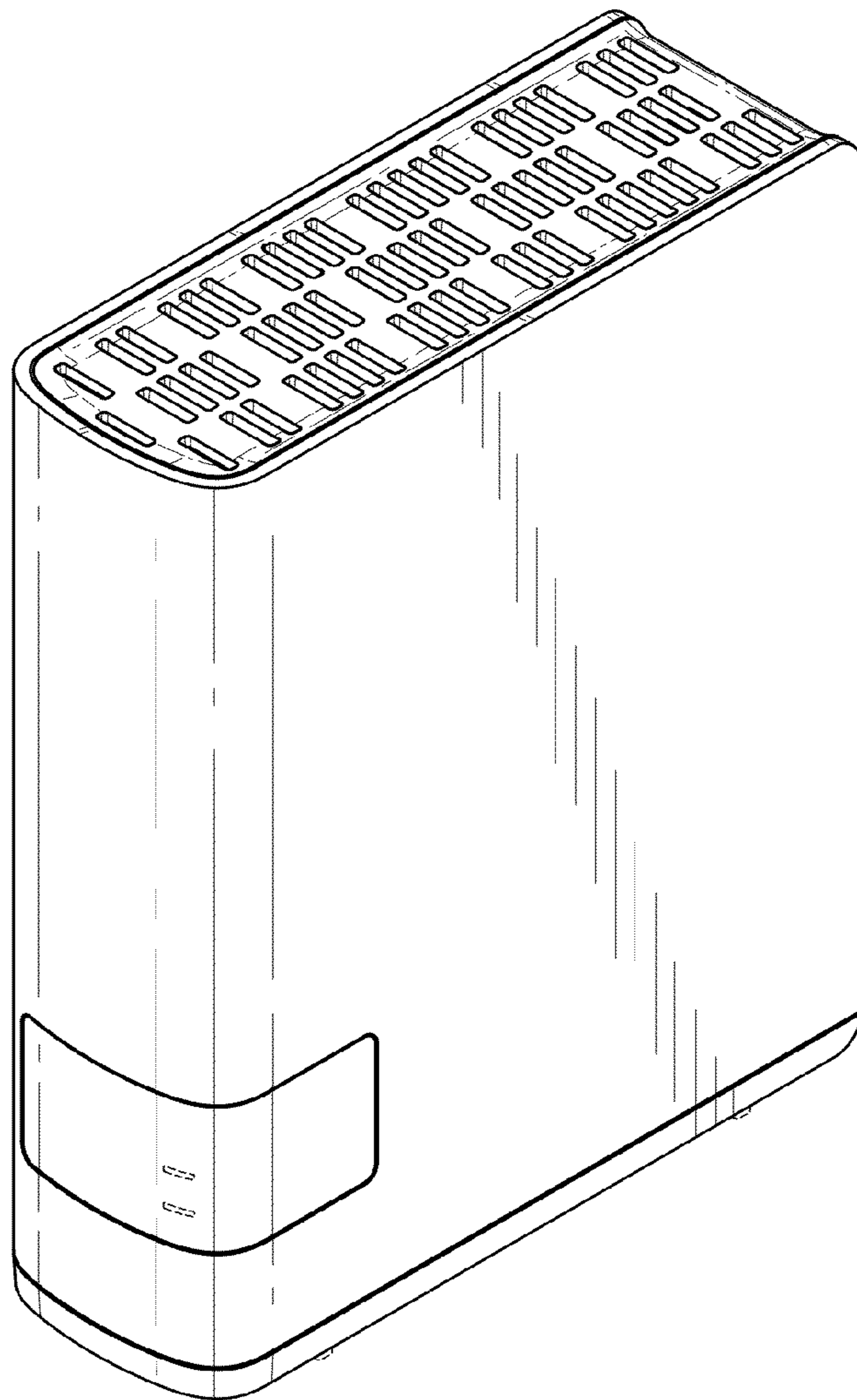

FIG. 1

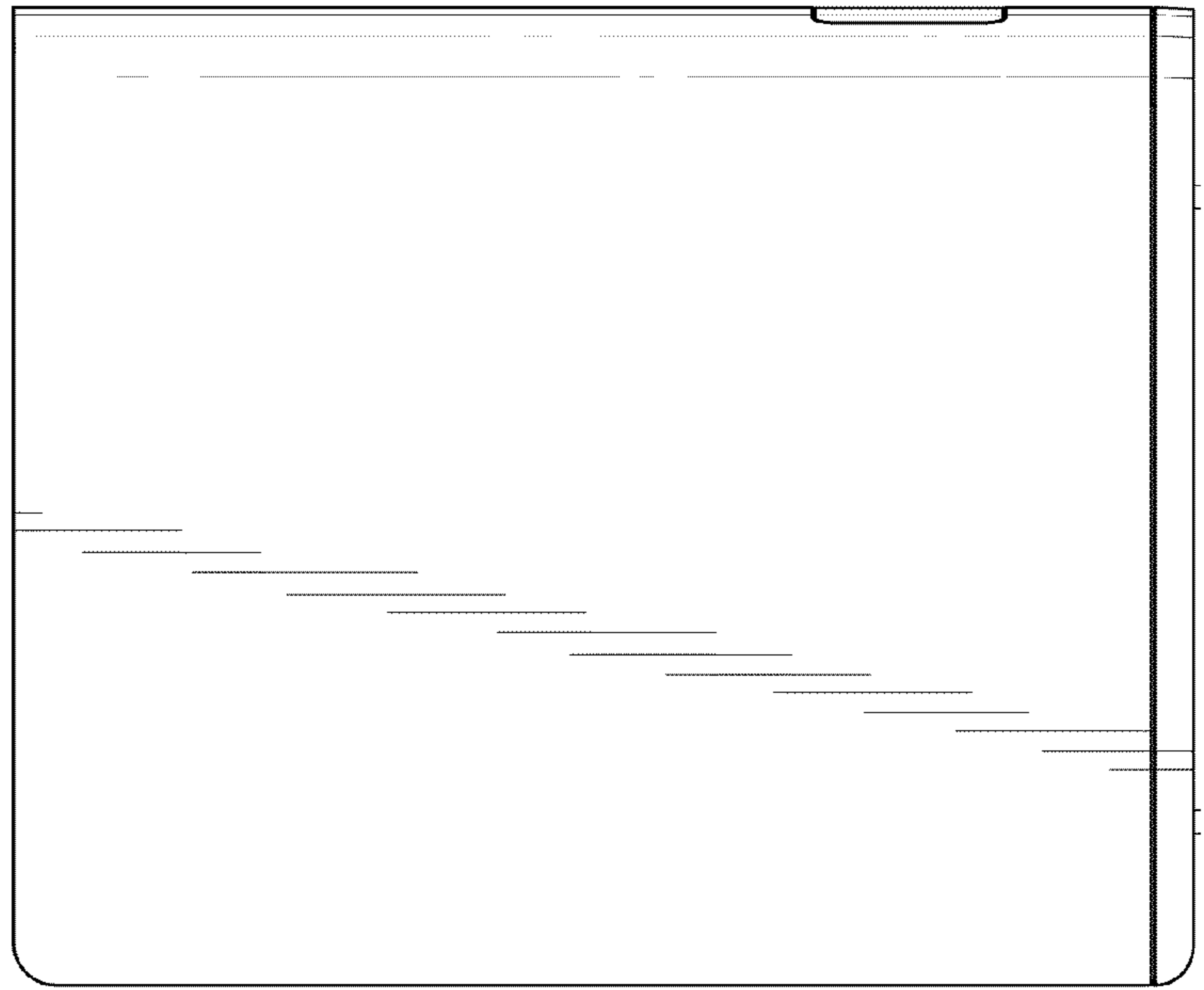

FIG. 3

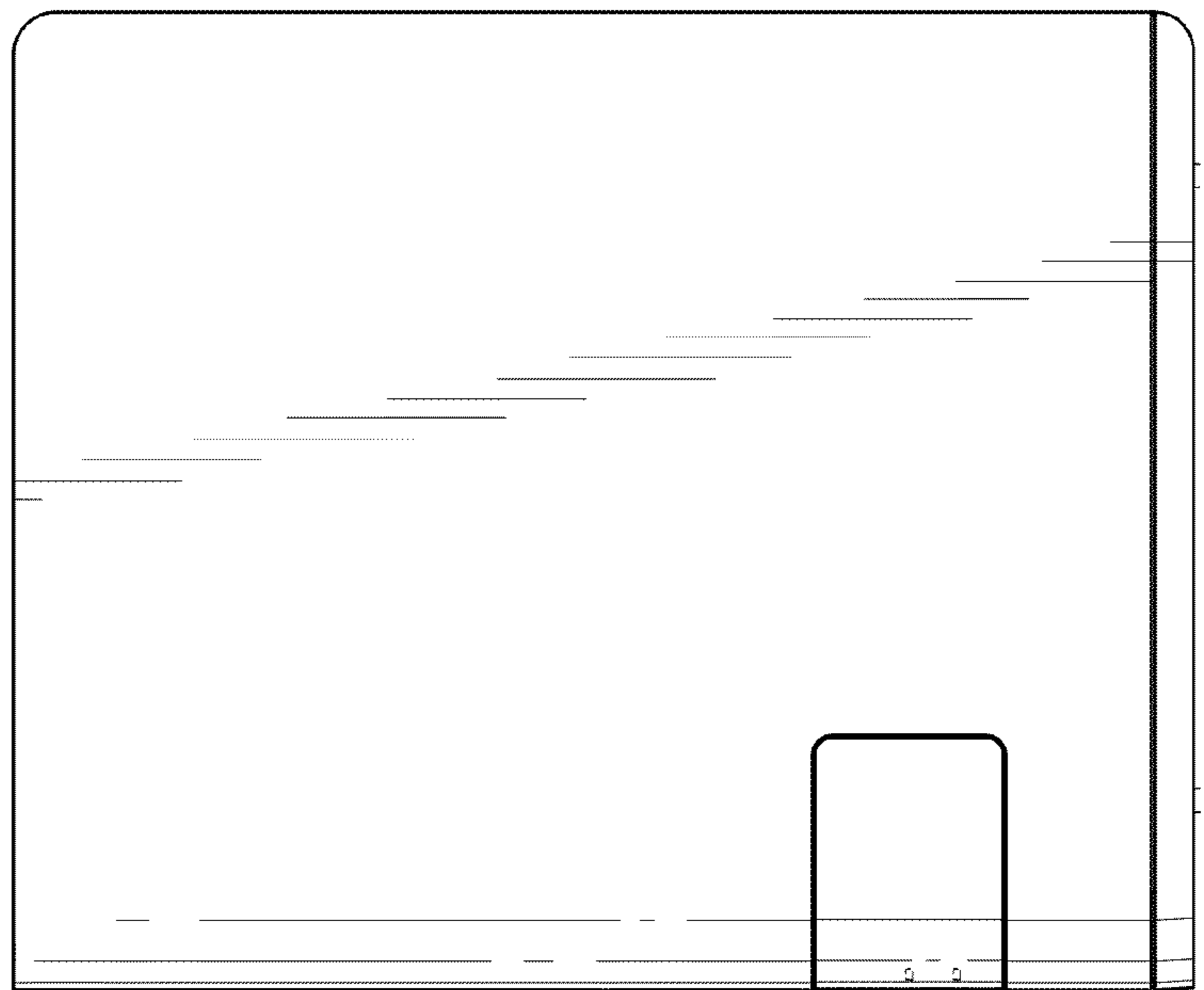

FIG. 2

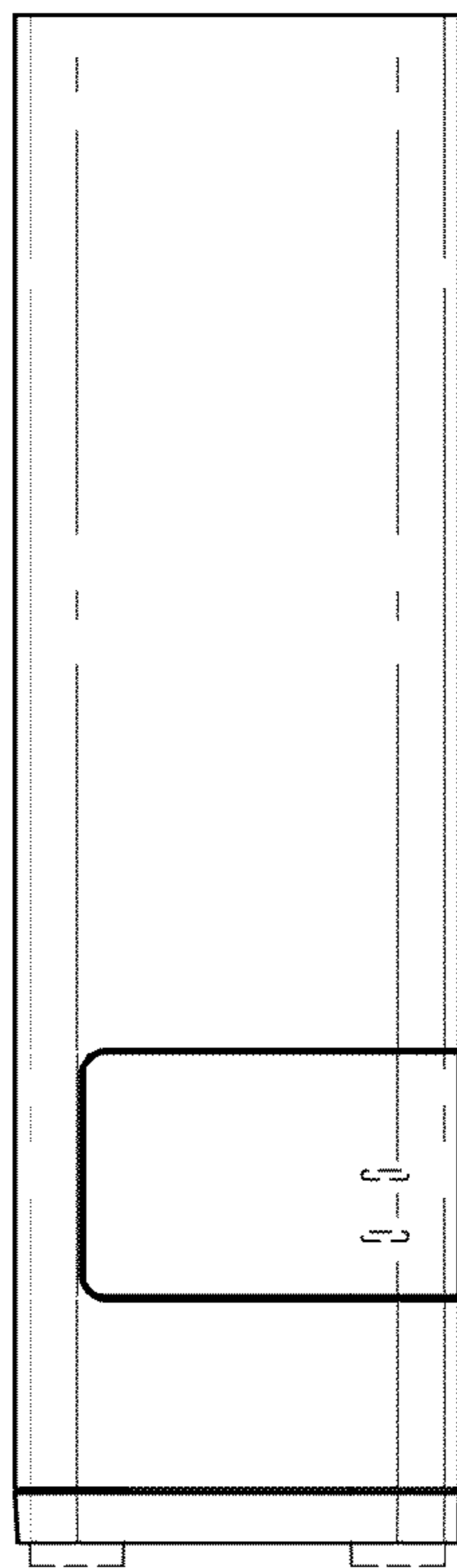

FIG. 4

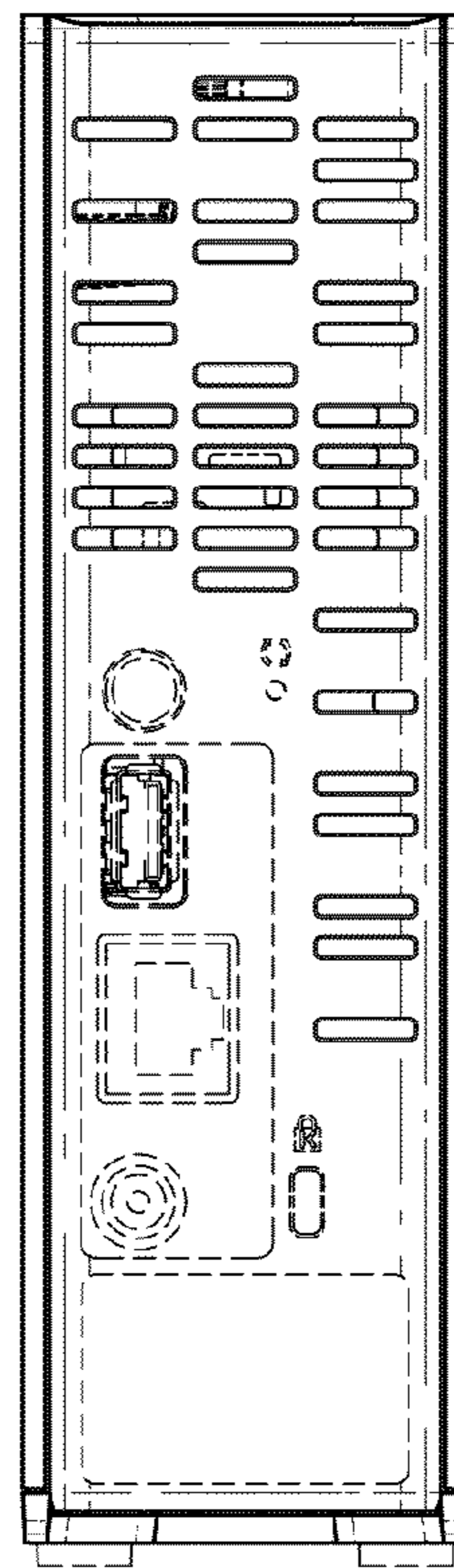

FIG. 5

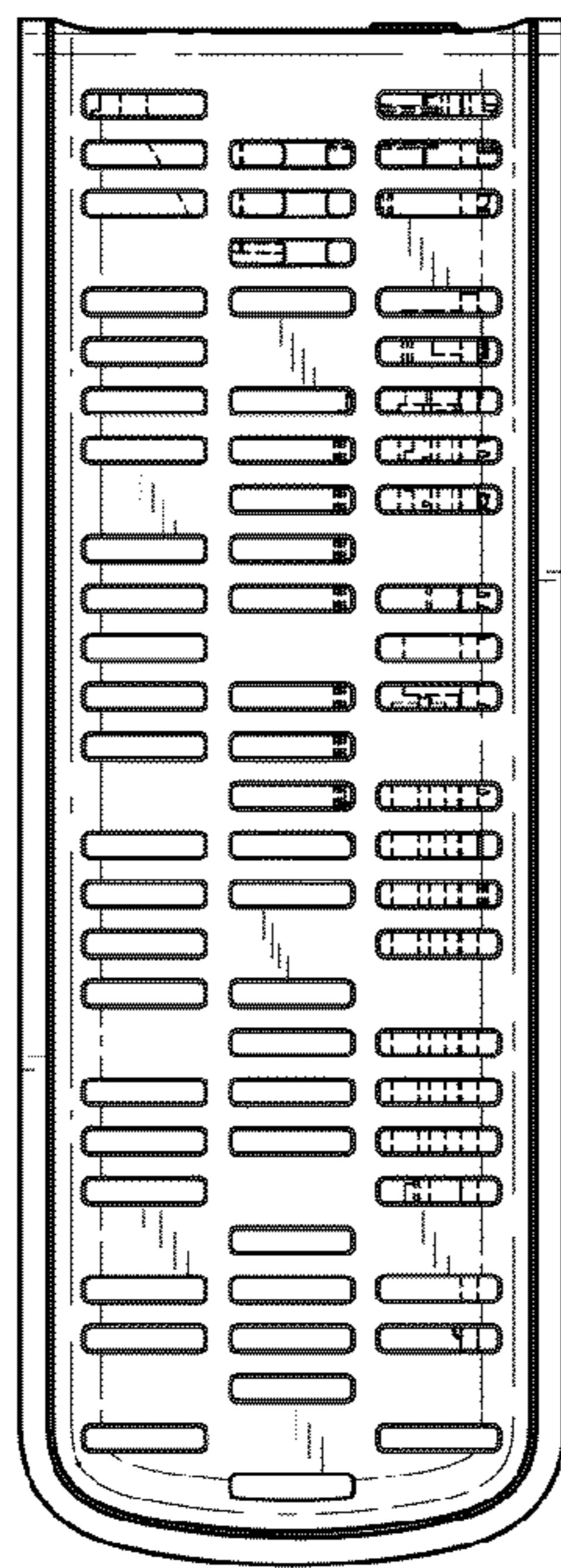

FIG. 6

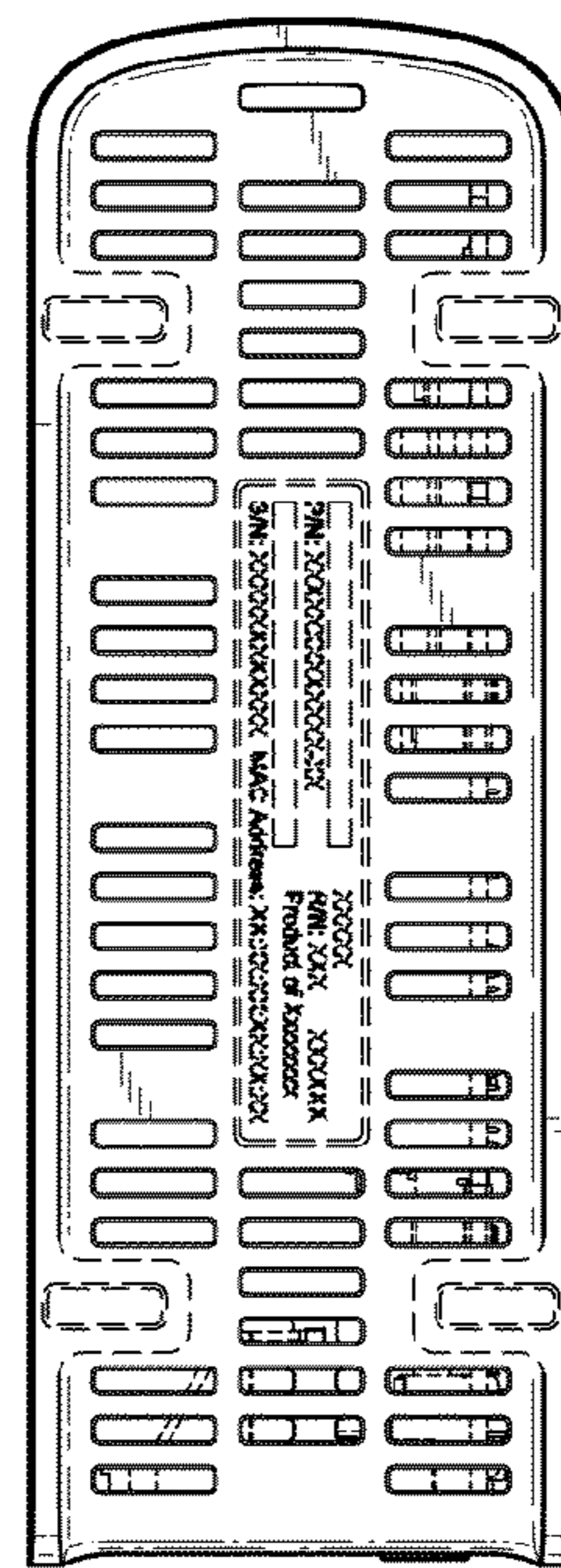

FIG. 7

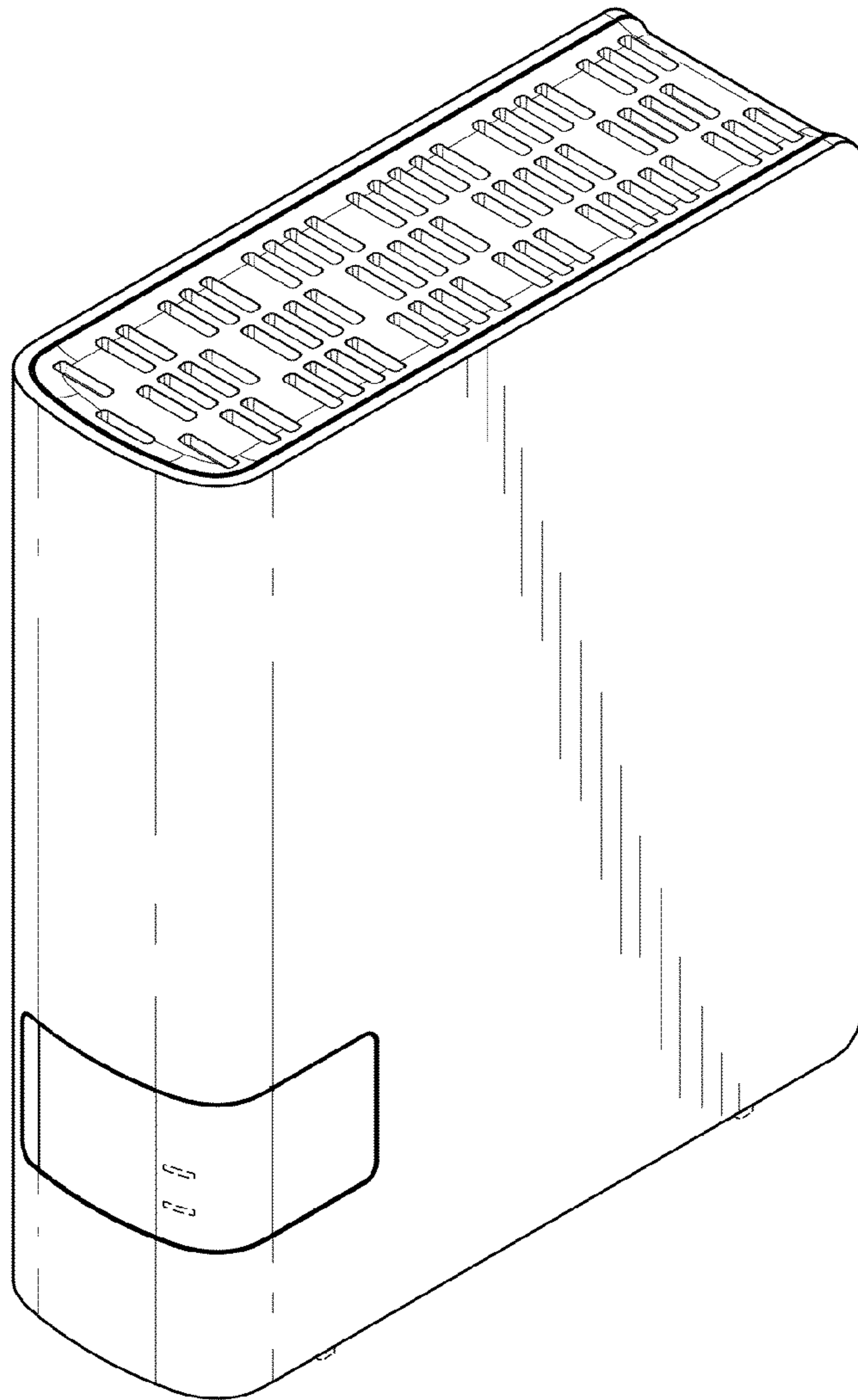

FIG. 8



FIG. 10

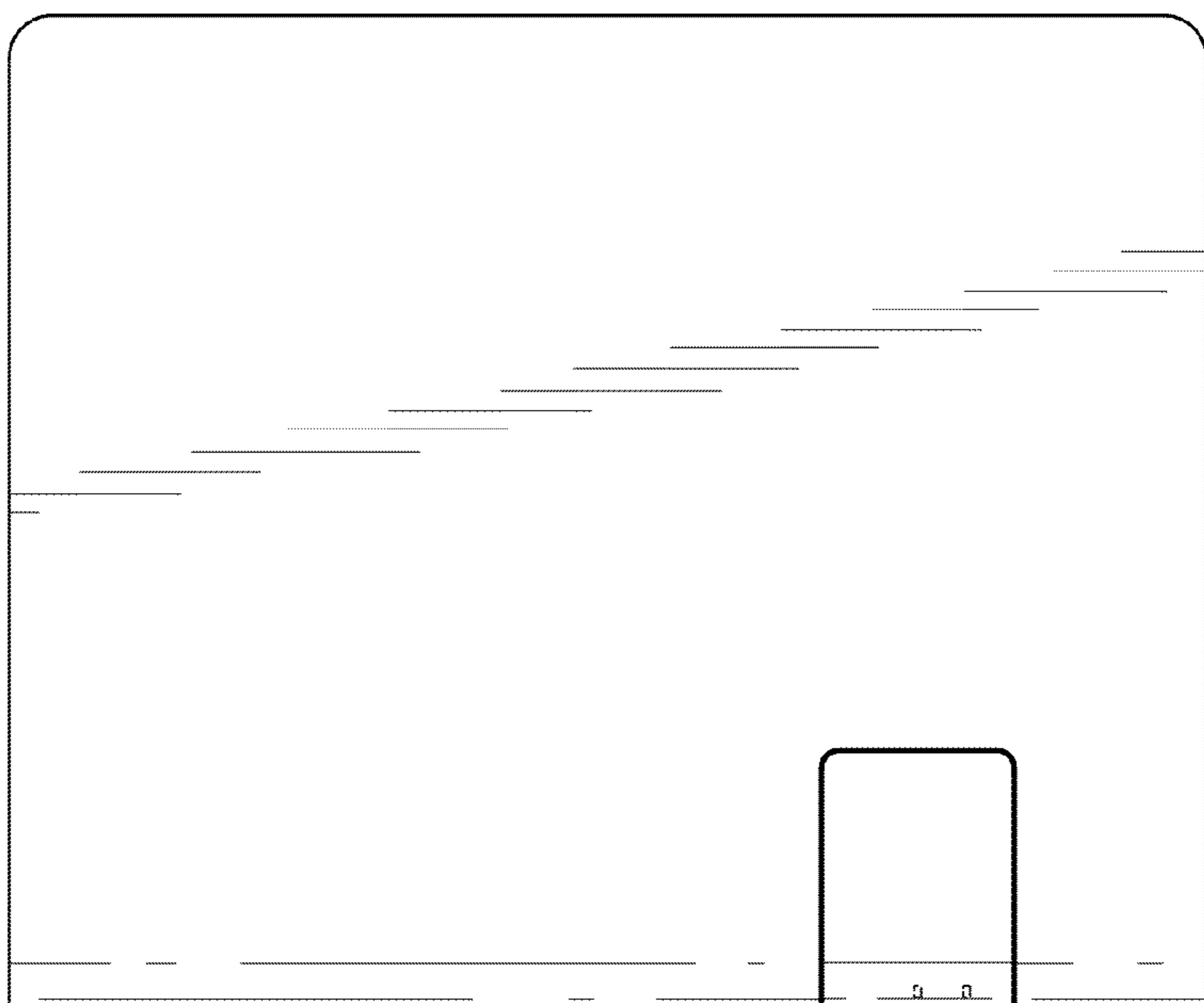

FIG. 9

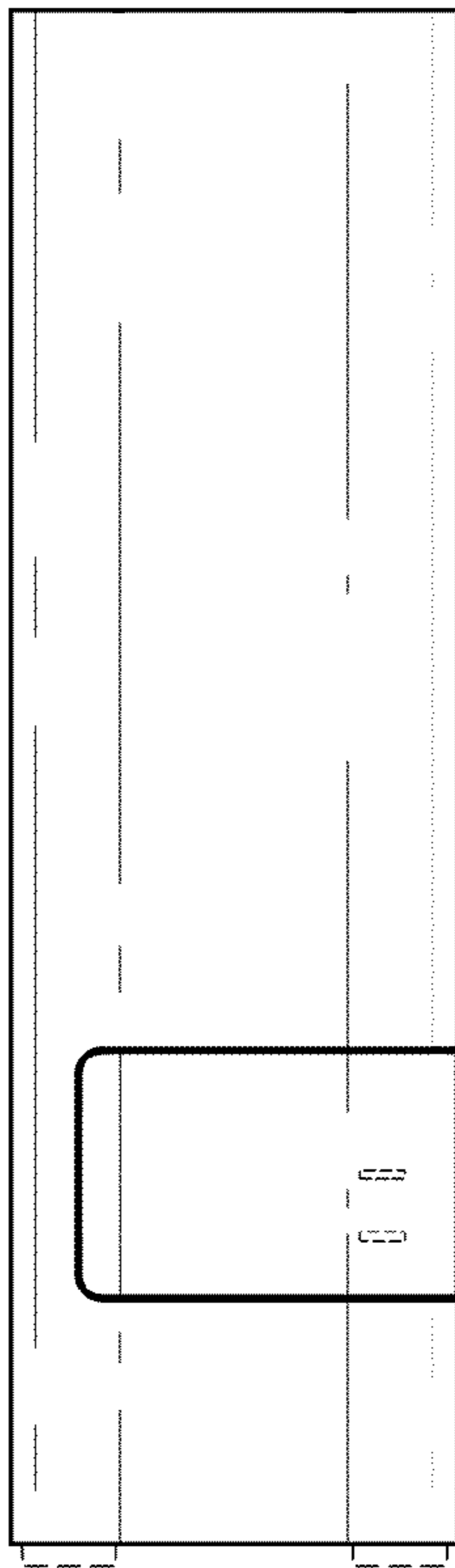

FIG. II

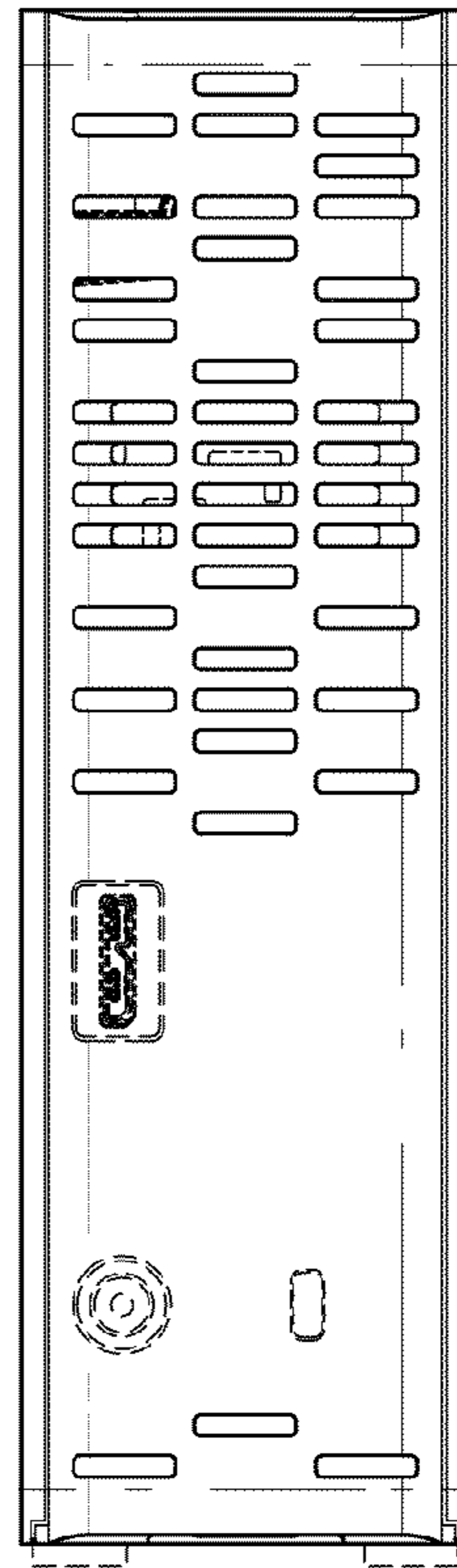

FIG. 12

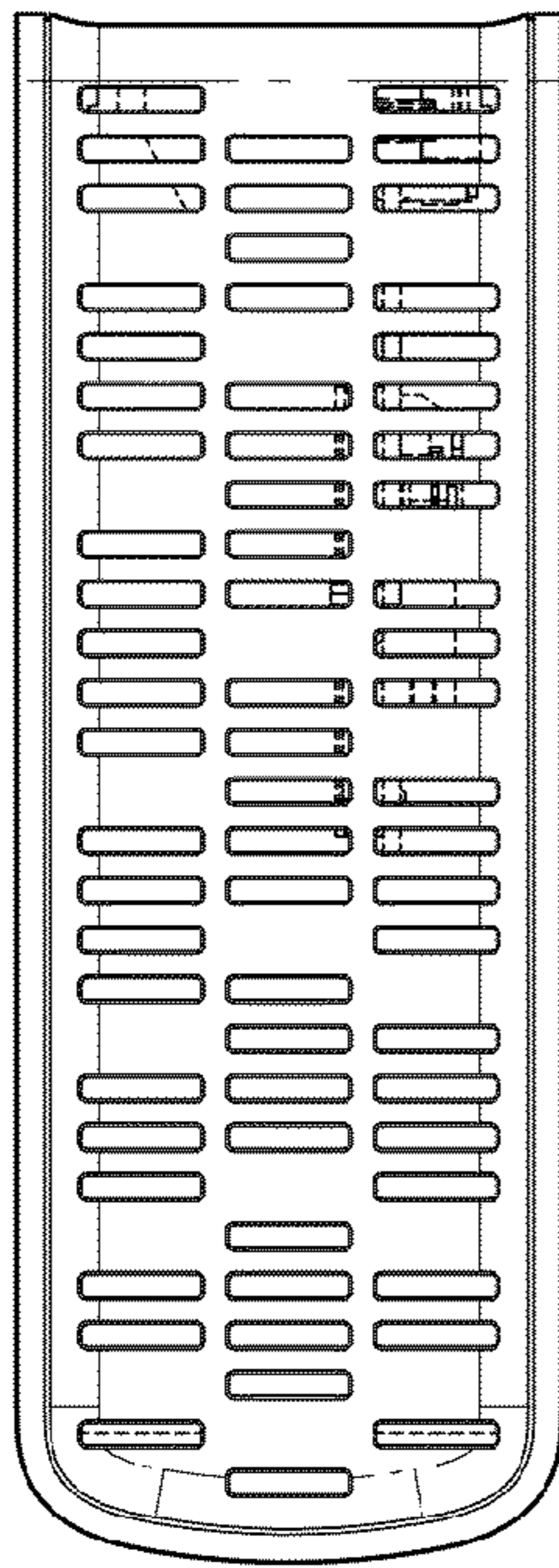

FIG. 13

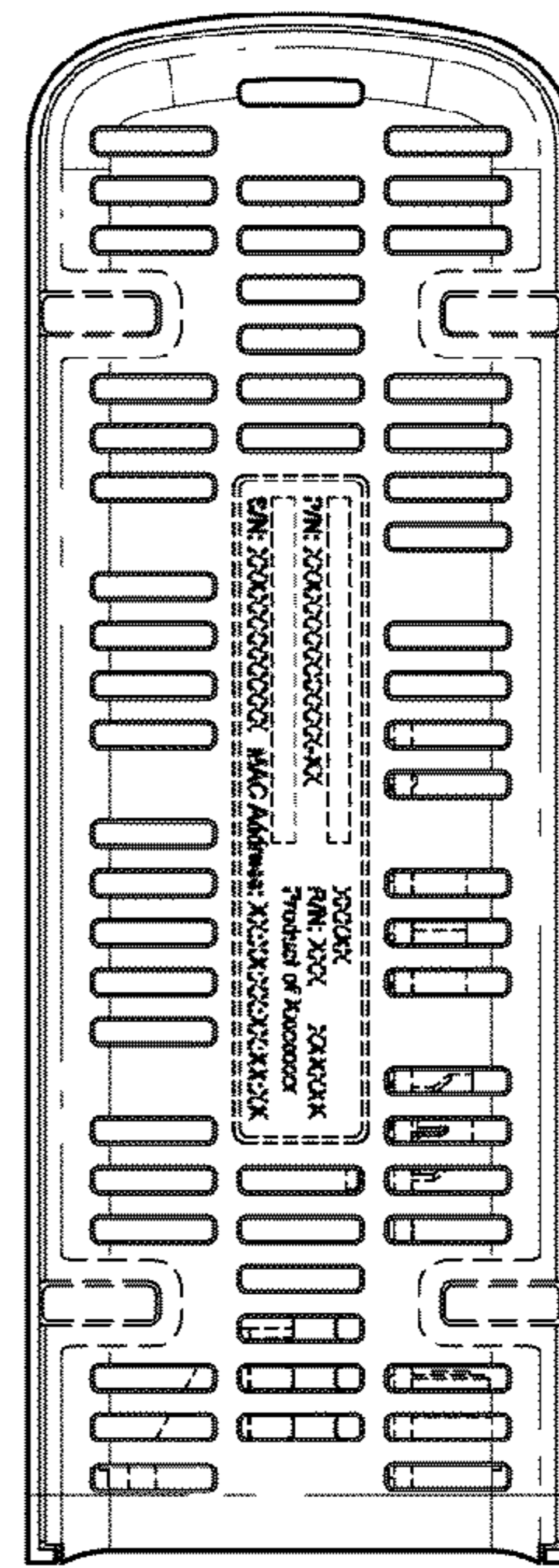

FIG. 14

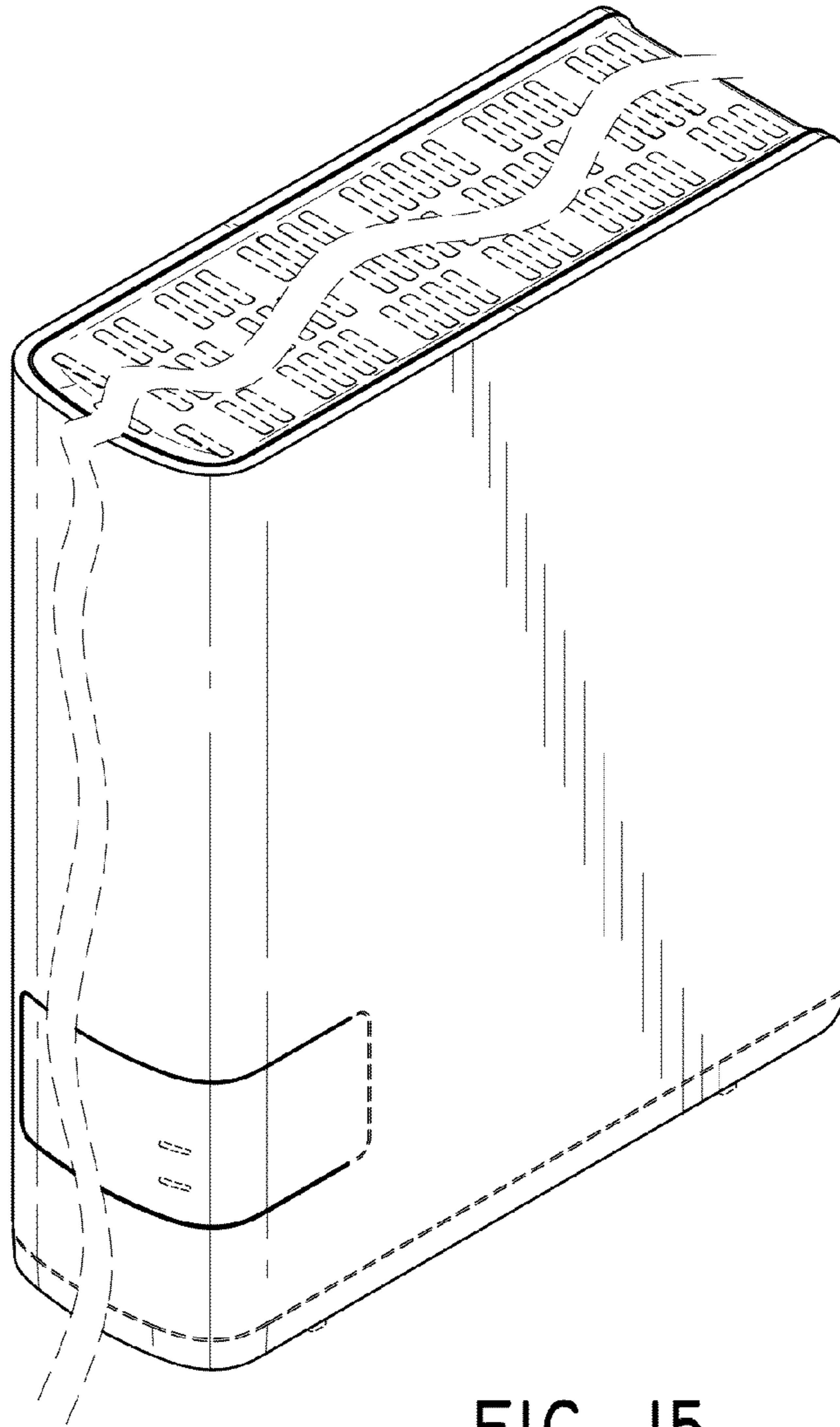

FIG. 15



FIG. 17

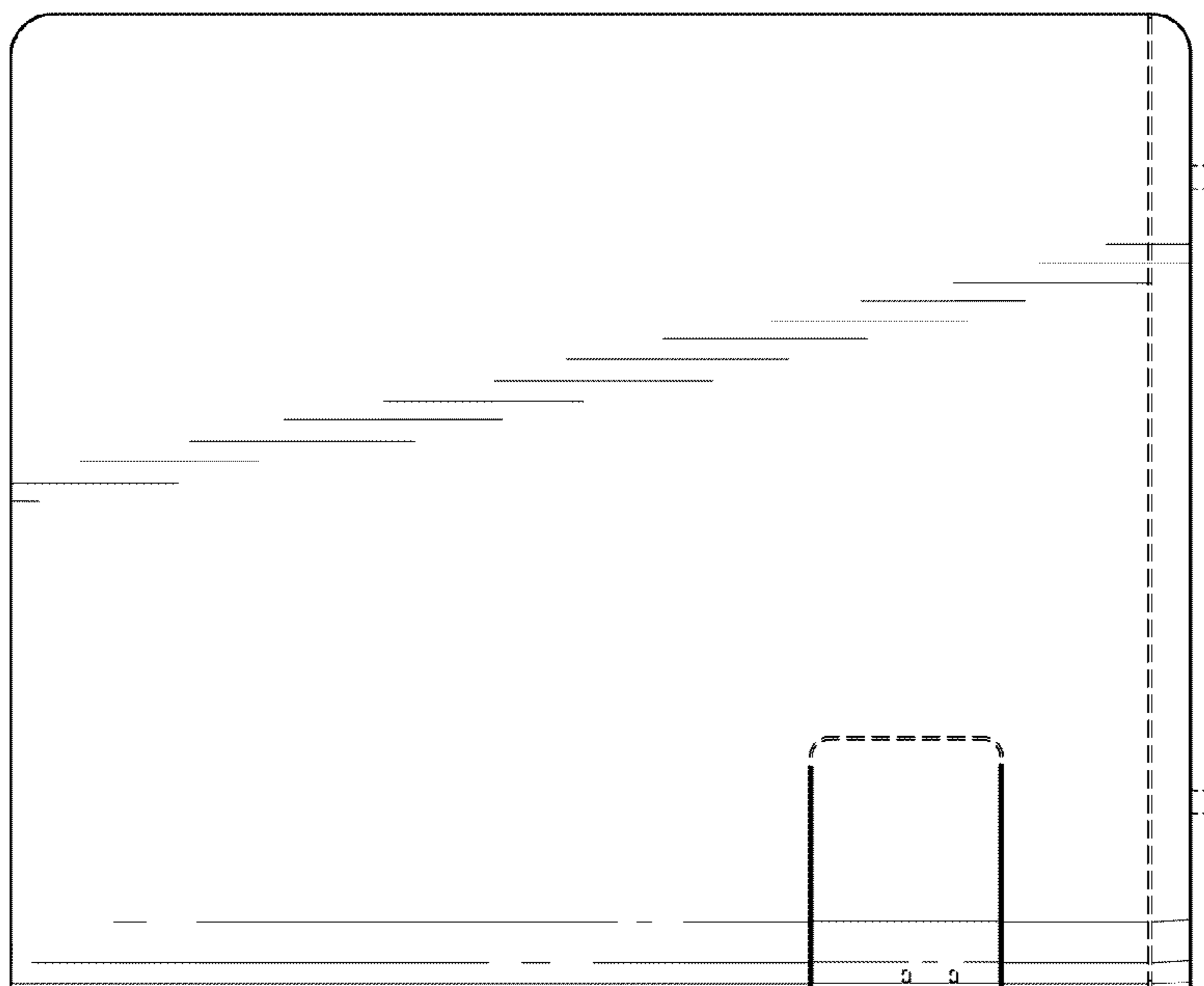

FIG. 16

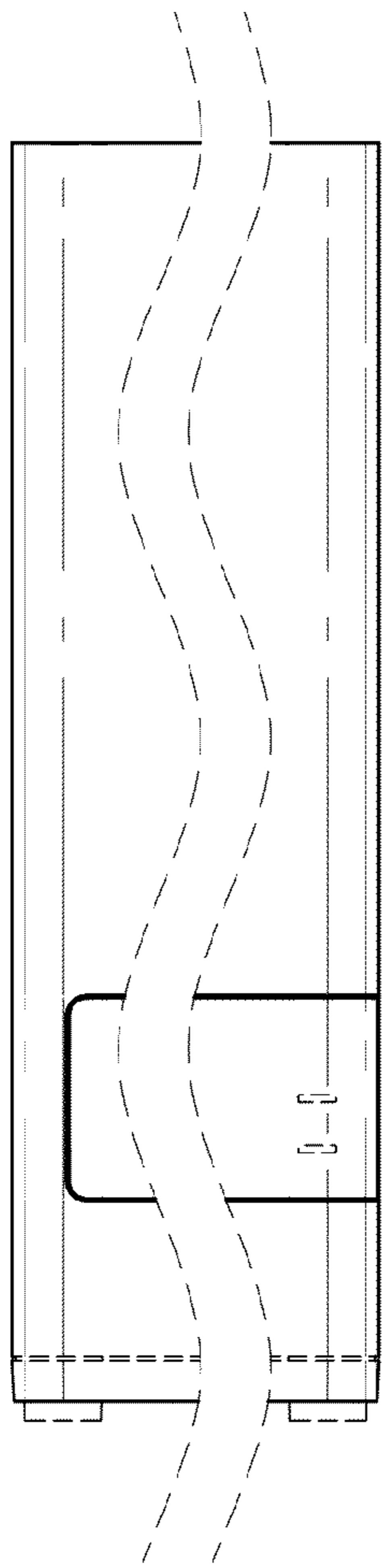

FIG. 18

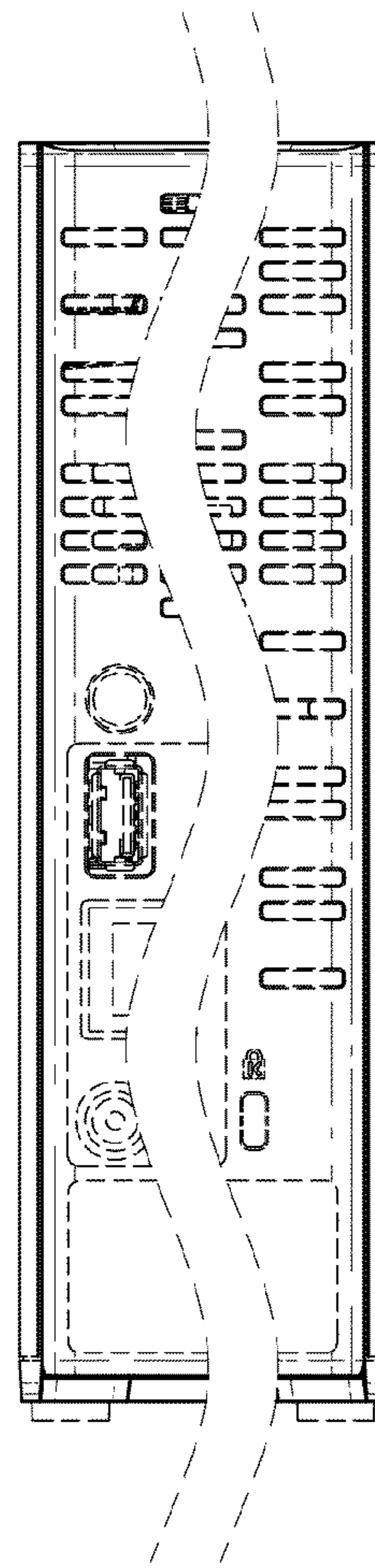

FIG. 19

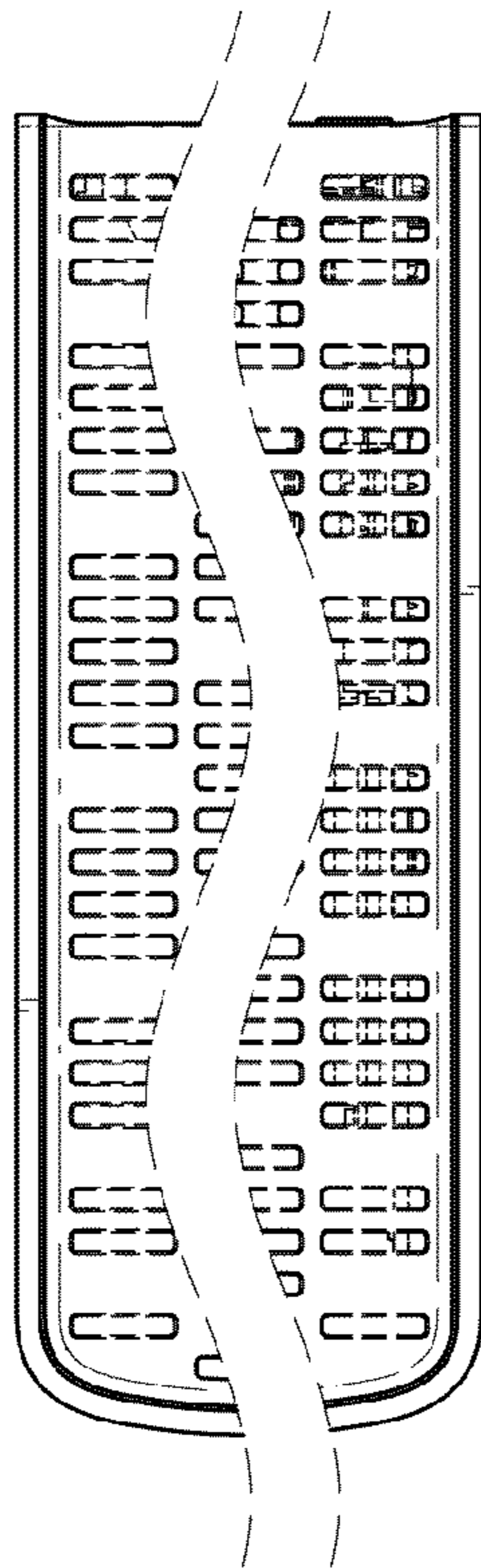

FIG. 20

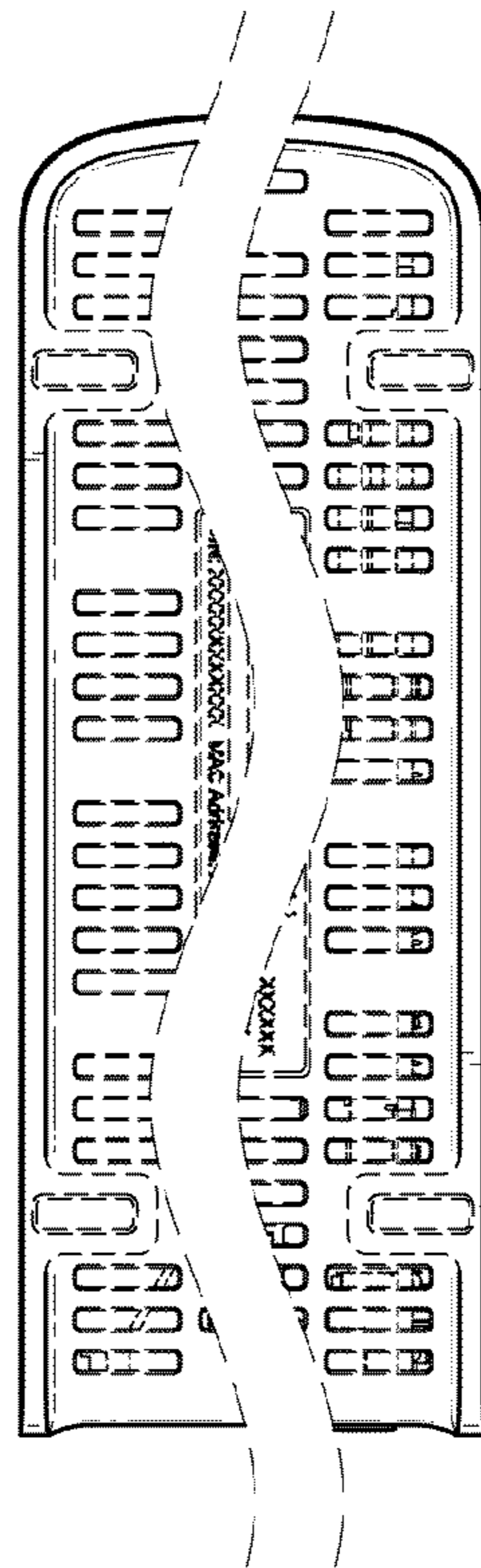

FIG. 21