



US00D737790S

(12) **United States Design Patent**
Cha et al.

(10) **Patent No.:** **US D737,790 S**
(45) **Date of Patent:** **** Sep. 1, 2015**

(54) **TELEVISION RECEIVER**

(56) **References Cited**

(71) Applicant: **LG Electronics Inc.**, Seoul (KR)

U.S. PATENT DOCUMENTS

(72) Inventors: **Hyunbyung Cha**, Seoul (KR); **Sunggu Joe**, Seoul (KR); **Hyeyoung Hong**, Seoul (KR)

D572,677 S *	7/2008	Niitsu	D14/126
D588,082 S *	3/2009	Arai	D14/126
D603,816 S *	11/2009	Kim et al.	D14/126
D646,243 S *	10/2011	Honda	D14/126
D654,446 S *	2/2012	Choi et al.	D14/126
D659,661 S *	5/2012	Lim et al.	D14/126
D661,270 S *	6/2012	Cha et al.	D14/126
D661,271 S *	6/2012	Hwangbo et al.	D14/126
D676,397 S *	2/2013	McManigal	D14/126
D678,853 S *	3/2013	Kim et al.	D14/126
D683,710 S *	6/2013	Jeon et al.	D14/126

(73) Assignee: **LG Electronics Inc.**, Seoul (KR)

(**) Term: **14 Years**

* cited by examiner

(21) Appl. No.: **29/460,044**

(22) Filed: **Jul. 8, 2013**

Primary Examiner — Randall Gholson

(30) **Foreign Application Priority Data**

(74) *Attorney, Agent, or Firm* — Morgan, Lewis & Bockius LLP

Jan. 7, 2013 (KR) 30-2013-0001037

(51) **LOC (10) Cl.** **14-03**

(57) **CLAIM**

The ornamental design for a television receiver, as shown and described.

(52) **U.S. Cl.**

USPC **D14/126**

DESCRIPTION

(58) **Field of Classification Search**

USPC D14/125–134, 239, 371, 136, 374–377, D14/440, 450, 448, 336, 342, 159; 312/7.2; 348/836, 838, 180, 184, 325, 739; 248/917–924, 465; 345/104, 133, 156, 345/168, 87, 173; D21/329, 515, 577, 622, D21/333, 433, 448, 452, 450, 331, 505; D10/15, 26; 446/484, 175, 356; D6/477, 479, 300; D24/185; D34/14
CPC ... G06F 1/1601; G06F 1/1643; H05K 5/0004; H05K 5/0017; H05K 5/02; H05K 5/0217
See application file for complete search history.

FIG. 1 is a perspective view of a television receiver showing our new design;
FIG. 2 is a front view thereof;
FIG. 3 is a rear view thereof;
FIG. 4 is a left side view thereof where the right side view is a mirror image;
FIG. 5 is a top plan view thereof;
FIG. 6 is a bottom plan view thereof; and,
FIG. 7 is a rear perspective view thereof.
The broken lines depict portions of the television receiver that form no part of the claimed design.

1 Claim, 7 Drawing Sheets

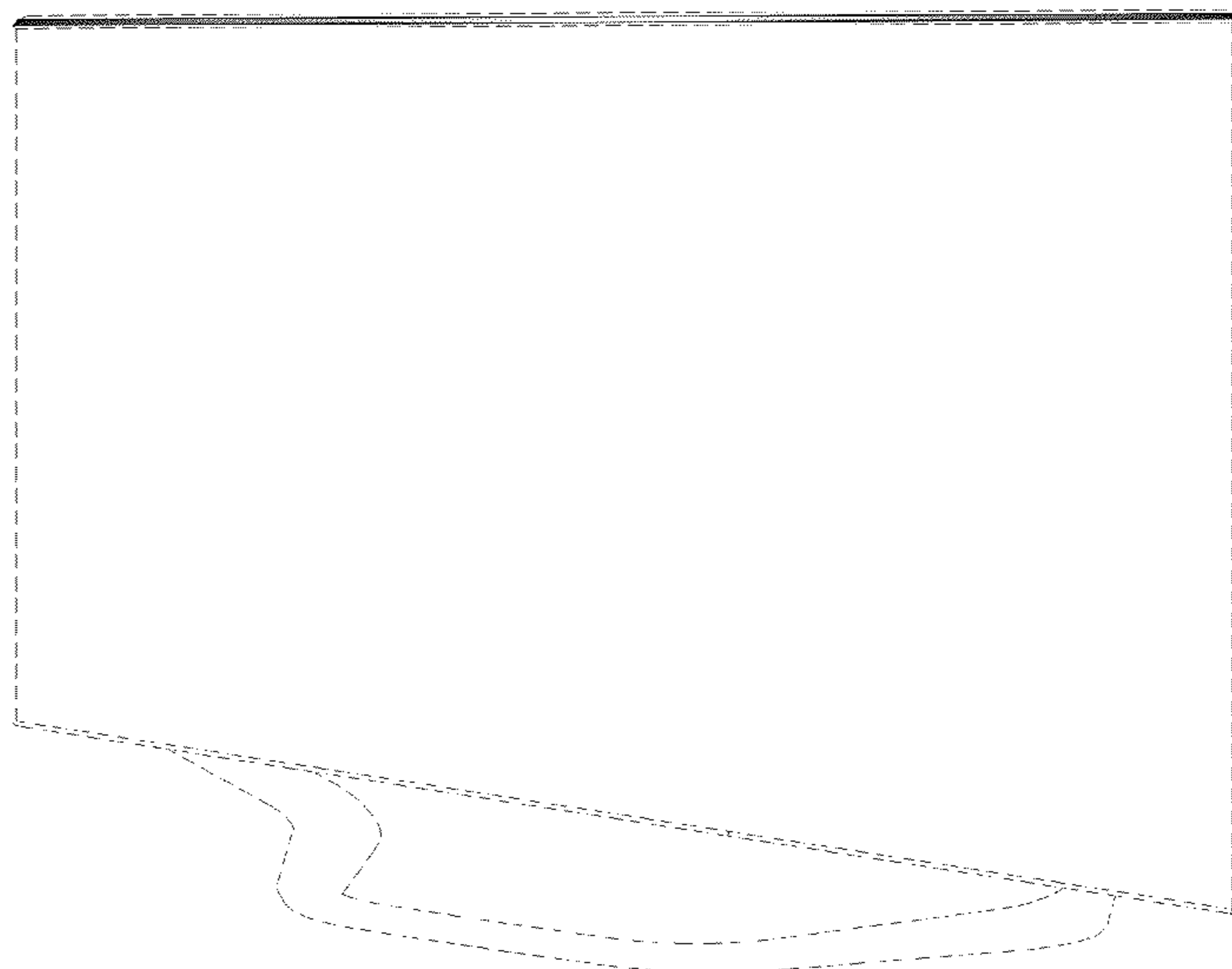

FIG. 1

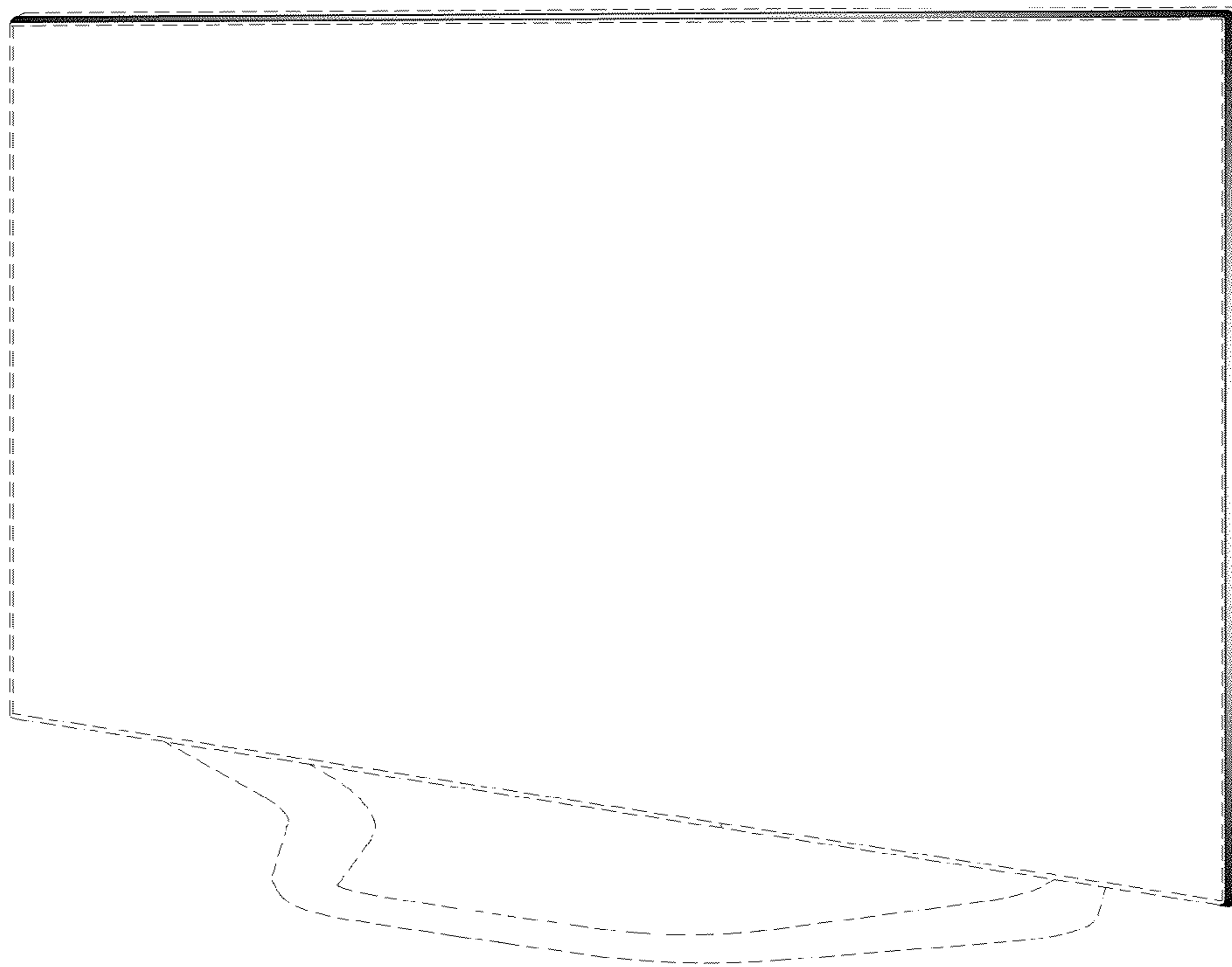

FIG. 2

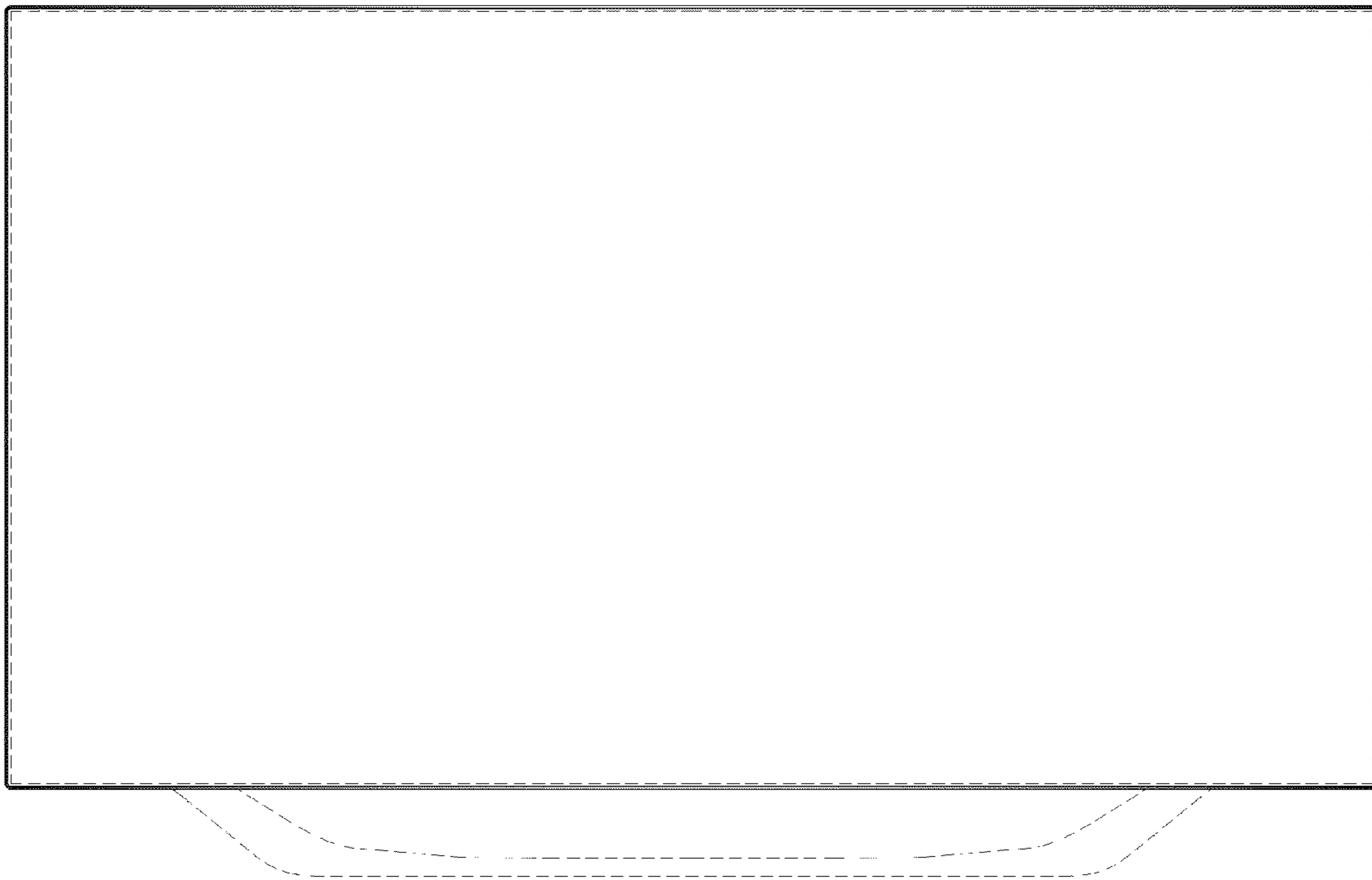

FIG. 3

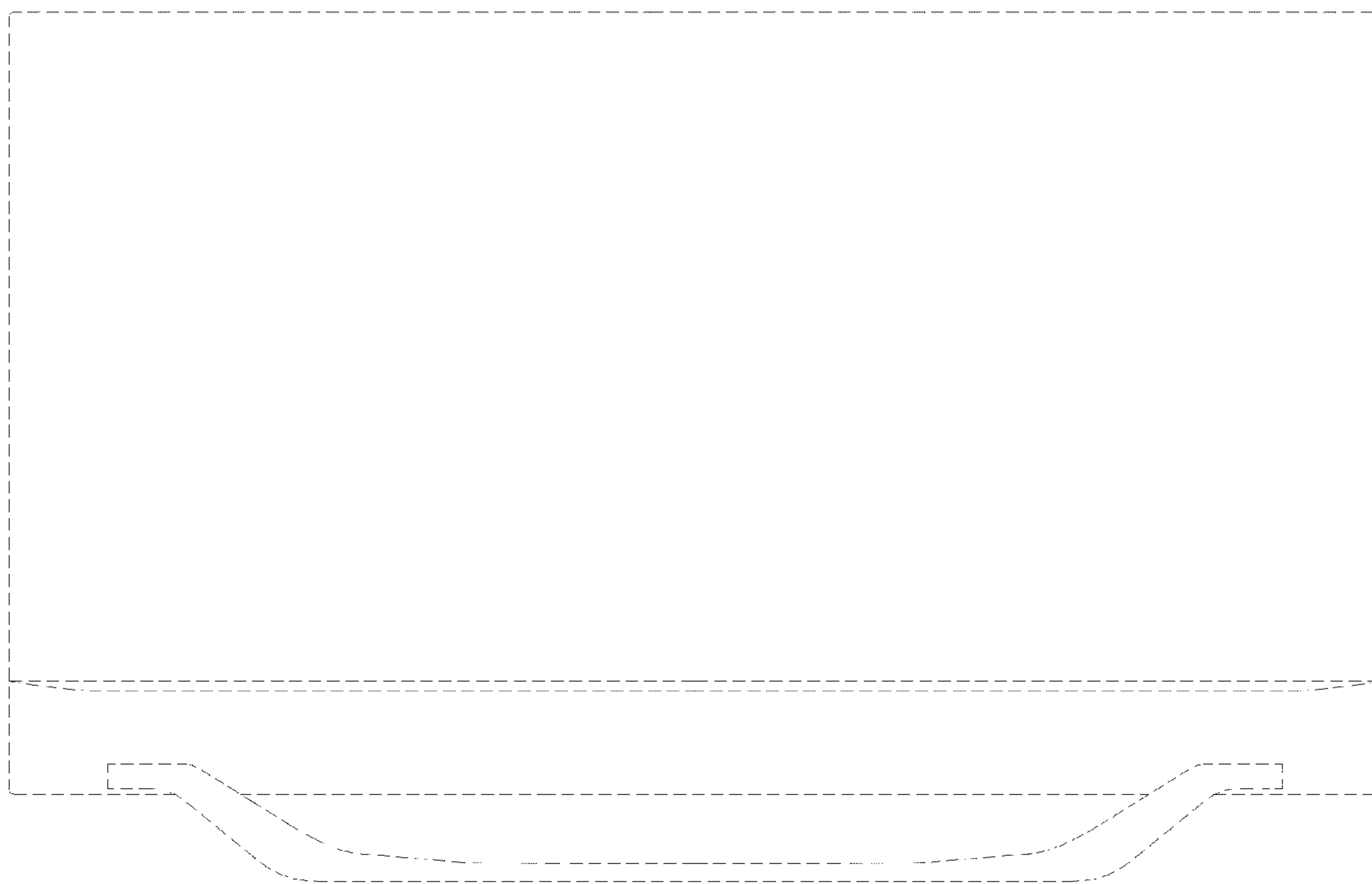

FIG. 4

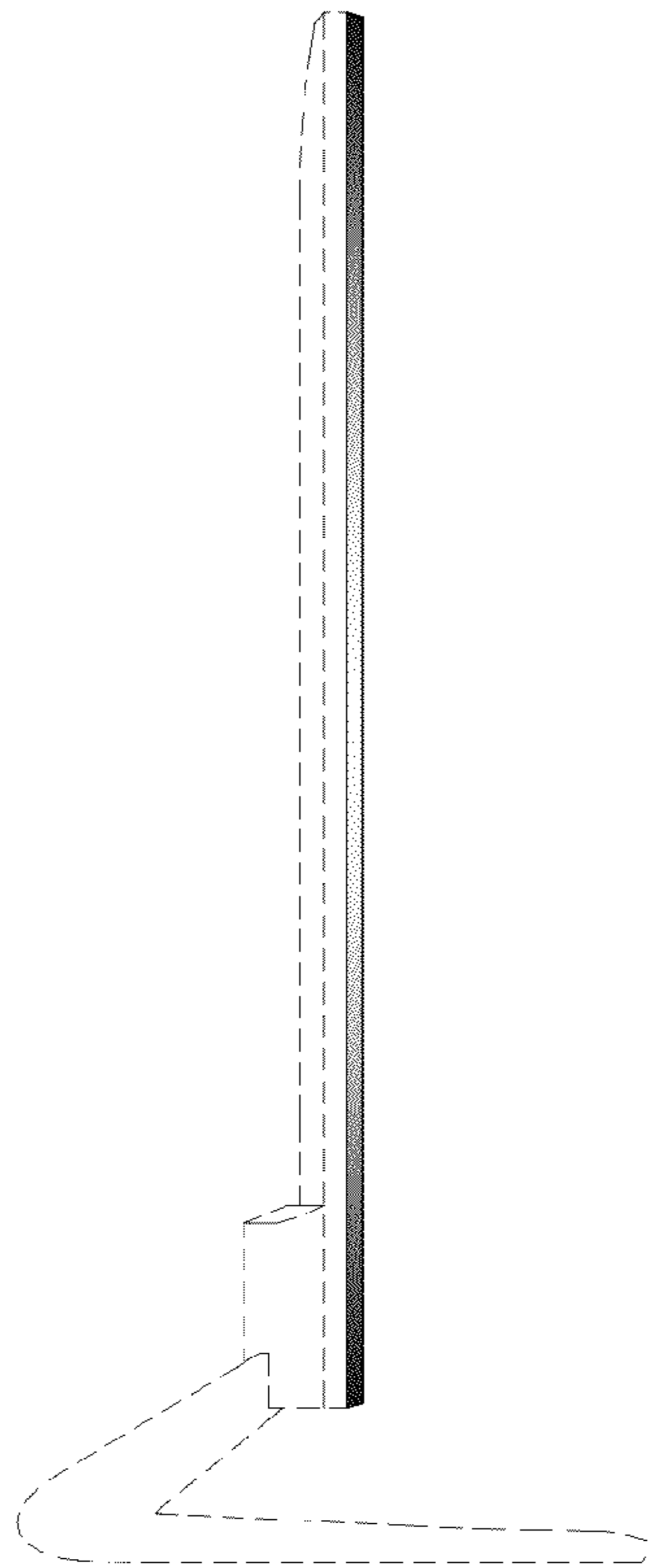

FIG. 5

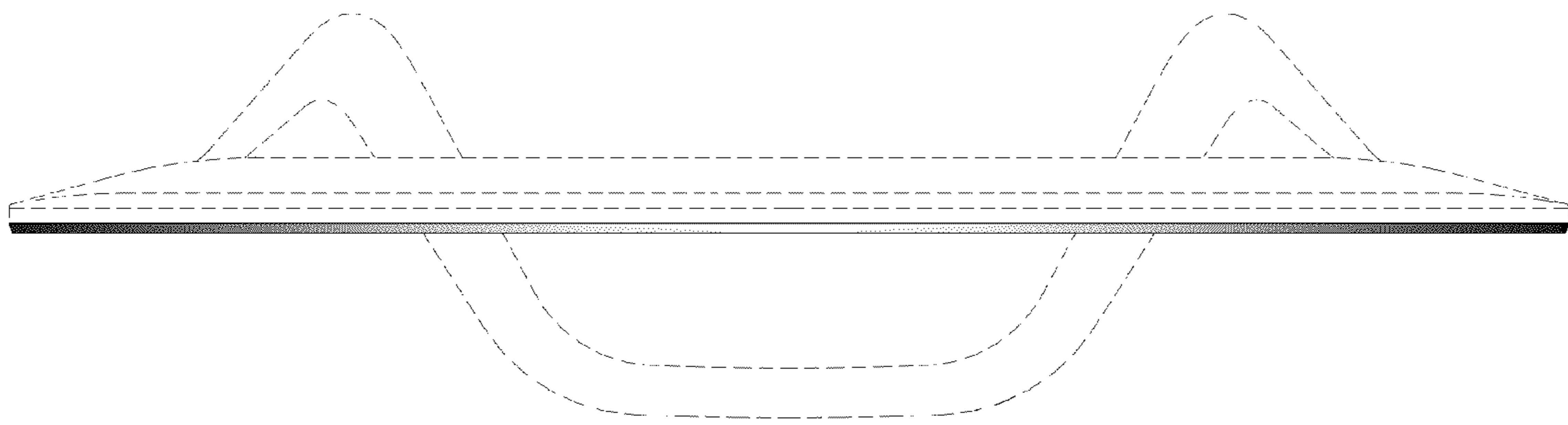

FIG. 6

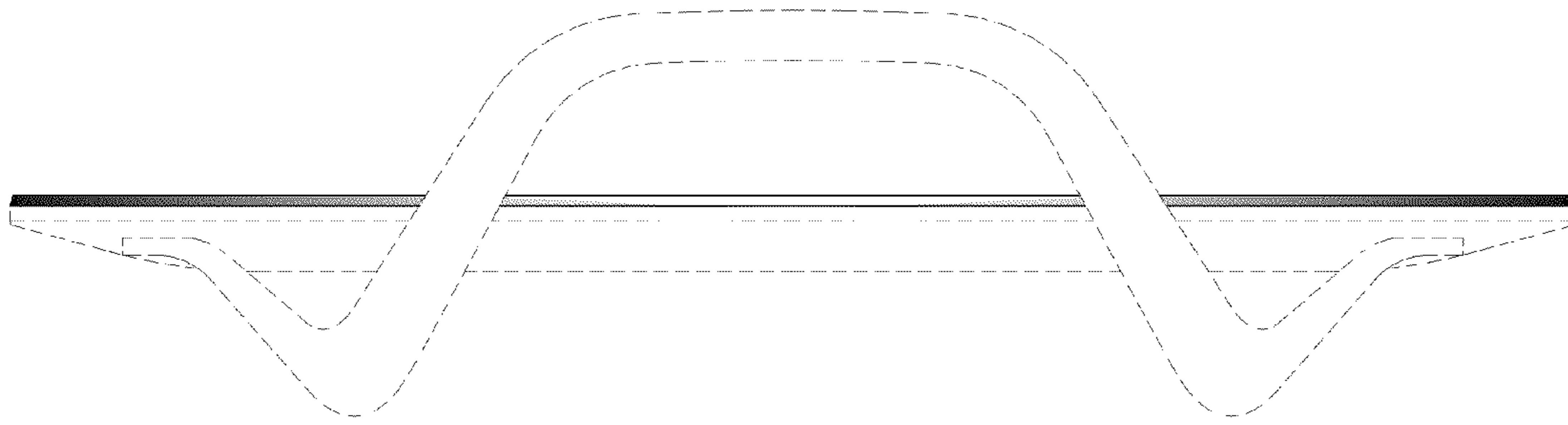

FIG. 7

