



US00D737629S

(12) **United States Design Patent**  
**Sands**

(10) **Patent No.:** **US D737,629 S**

(45) **Date of Patent:** **\*\* Sep. 1, 2015**

(54) **MIXING VESSEL**

(71) Applicant: **Lenny Sands**, Los Angeles, CA (US)

(72) Inventor: **Lenny Sands**, Los Angeles, CA (US)

(73) Assignee: **Homeland Housewares, LLC**, Los Angeles, CA (US)

(\*\*) Term: **14 Years**

(21) Appl. No.: **29/486,285**

(22) Filed: **Mar. 27, 2014**

(51) **LOC (10) Cl.** ..... **31-00**

(52) **U.S. Cl.**  
USPC ..... **D7/413**; D7/376; D7/378; D7/412

(58) **Field of Classification Search**  
USPC ..... D7/372, 376-386, 412-413, 505, 602,  
D7/629, 665-666, 669, 679, 693-694;  
D9/429

CPC ..... A21C 1/02; A21C 1/04; A23N 1/00;  
A23N 1/02; A47J 43/04; A47J 43/25; A47J  
43/27; A47J 43/042; A47J 43/044; A47J  
43/046; A47J 43/075; A47J 43/0722; A47J  
43/0727; A47J 43/0766; B01F 3/00; B01F  
3/0807; B01F 3/0853; B01F 13/0059; B01F  
13/0064; B02C 1/08; B02C 2/04; B02C 4/42;  
B02C 4/142; B02C 4/143; B02C 4/423;  
B02C 13/1835; B28C 5/10; B28C 5/12;  
B28C 5/14; B28C 5/16

See application file for complete search history.

(56) **References Cited**

**U.S. PATENT DOCUMENTS**

D487,668 S \* 3/2004 Sands ..... D7/378  
D518,994 S \* 4/2006 Lin ..... D7/378  
7,063,009 B2 \* 6/2006 Lin ..... 99/492  
D530,975 S \* 10/2006 Fernandez ..... D7/378  
D554,426 S \* 11/2007 Sands ..... D7/378  
D554,427 S \* 11/2007 Sands ..... D7/378

D572,076 S \* 7/2008 Ling ..... D7/384  
D665,620 S \* 8/2012 Chapman et al. .... D7/376  
D666,057 S \* 8/2012 Theuretzbacher ..... D7/413  
D668,114 S \* 10/2012 Cozzolino et al. .... D7/412  
D697,798 S \* 1/2014 Sorensen et al. .... D9/429  
D712,196 S \* 9/2014 Ho et al. .... D7/378  
D727,097 S \* 4/2015 Sorensen et al. .... D7/505

**FOREIGN PATENT DOCUMENTS**

JP D1152984 9/2002  
KR 30-0283056 11/2001  
TW D125234 10/2008

**OTHER PUBLICATIONS**

Decision of Refusal from Japan Patent Office.  
Office Action from Japan Patent Office.  
Office Action from Taiwan Intellectual Property Office.

\* cited by examiner

*Primary Examiner* — Ricky Pham  
(74) *Attorney, Agent, or Firm* — Trojan Law Offices

(57) **CLAIM**  
The ornamental design for a mixing vessel, as shown and described.

**DESCRIPTION**

FIG. 1 is a perspective view of a mixing vessel of my new design;  
FIG. 2 is a perspective view of the mixing vessel shown in FIG. 1, assembled with a blade holder;  
FIG. 3 is a front elevation view of the mixing vessel shown in FIG. 1, the rear elevation view being a mirror image;  
FIG. 4 is a left side elevation view of the mixing vessel shown in FIG. 1;  
FIG. 5 is a right side elevation view of the mixing vessel shown in FIG. 1;  
FIG. 6 is a bottom plan view of the mixing vessel shown in FIG. 1; and,  
FIG. 7 is a top plan view of the mixing vessel shown in FIG. 1.  
The broken line portions of the disclosure are for illustrative purposes only and form no part of the claimed design.

**1 Claim, 4 Drawing Sheets**

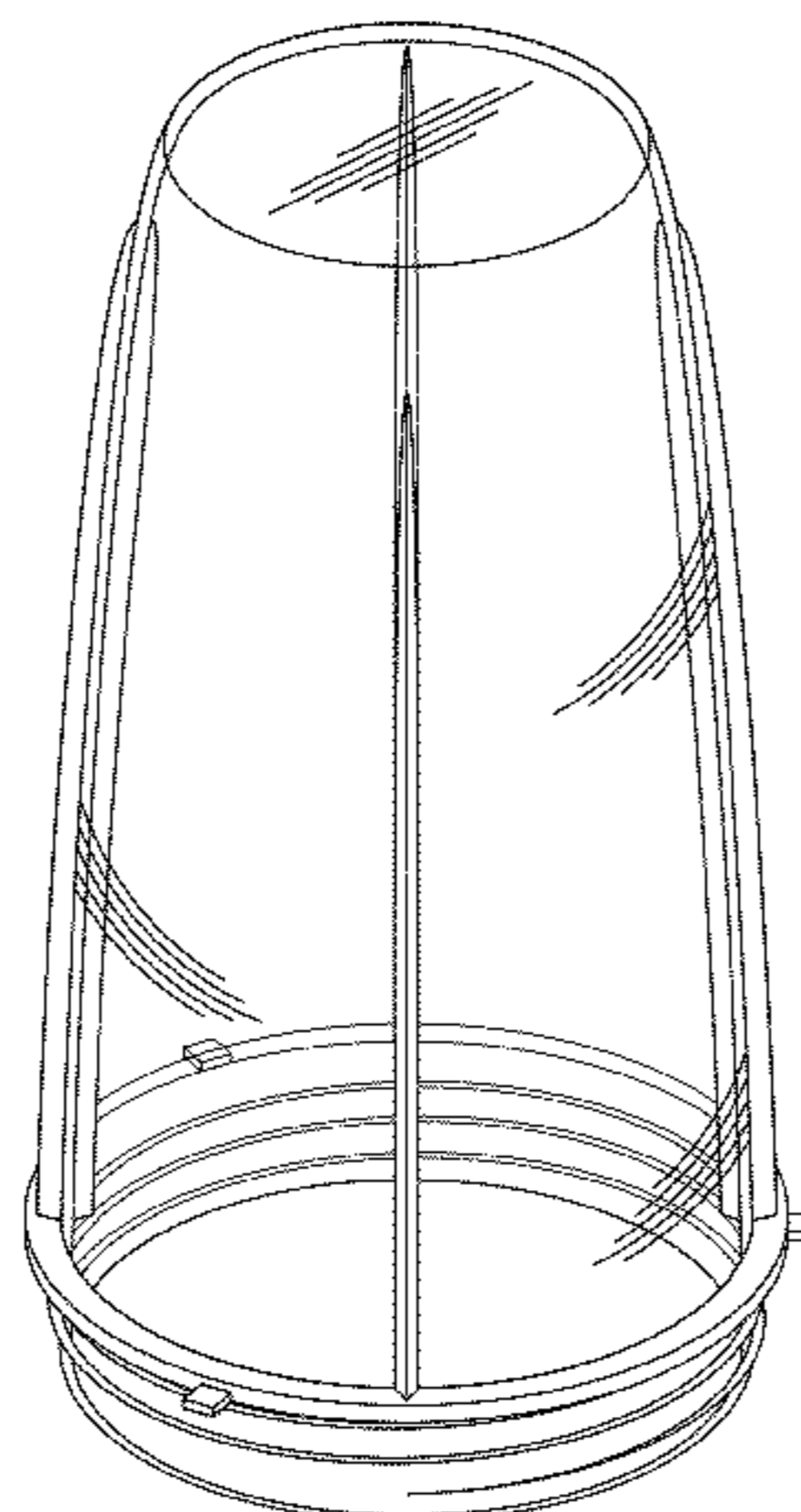

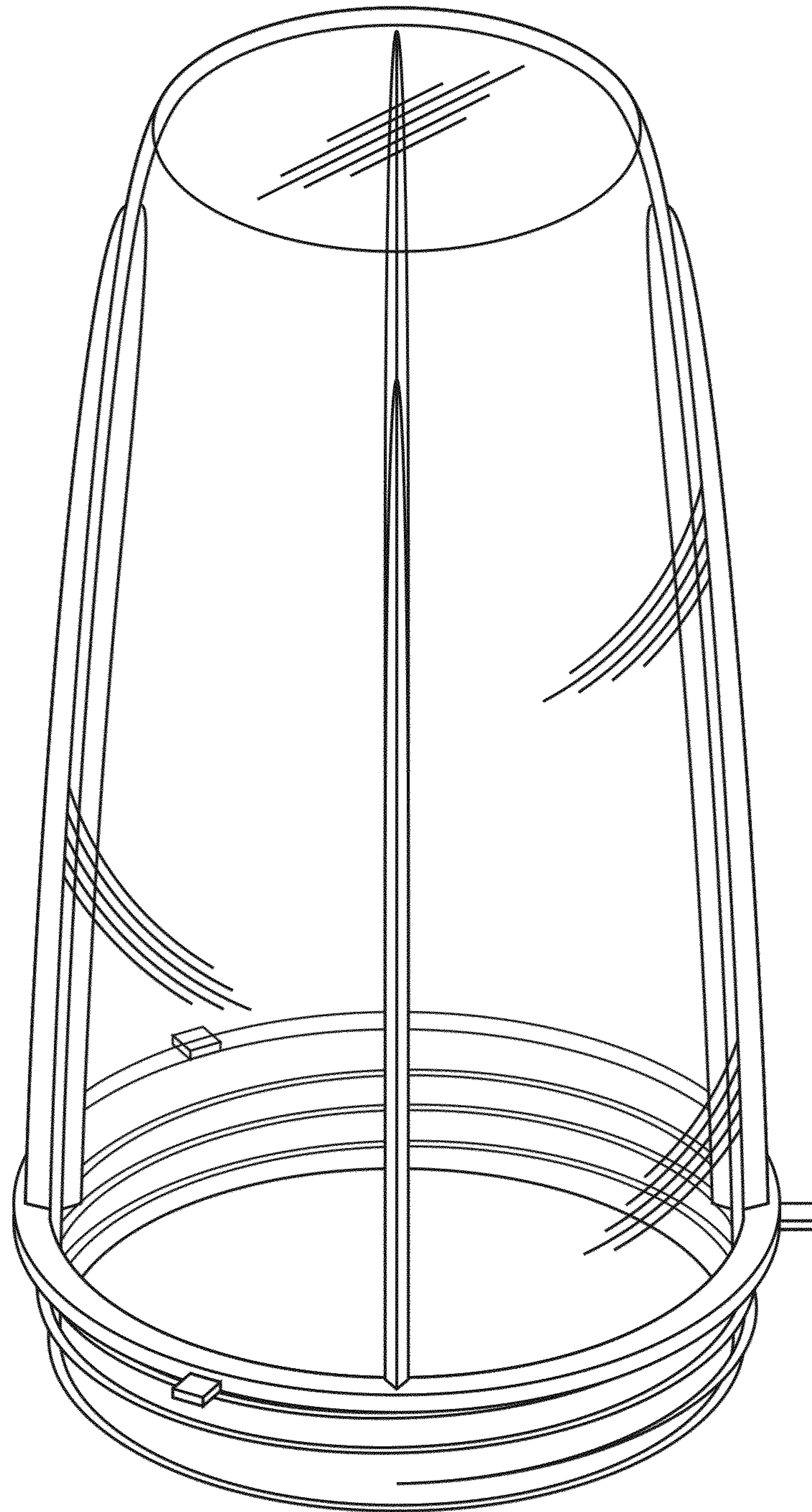

**Fig. 1**

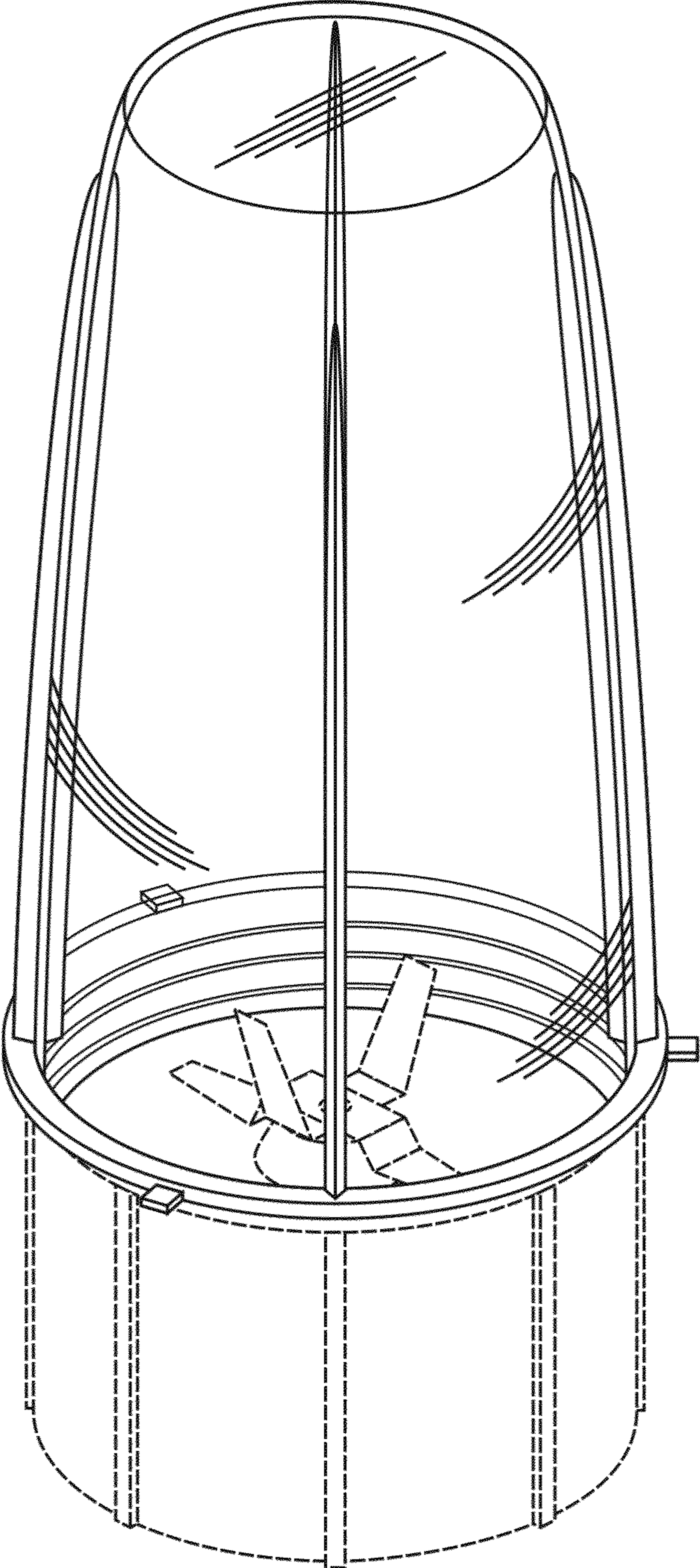

Fig. 2

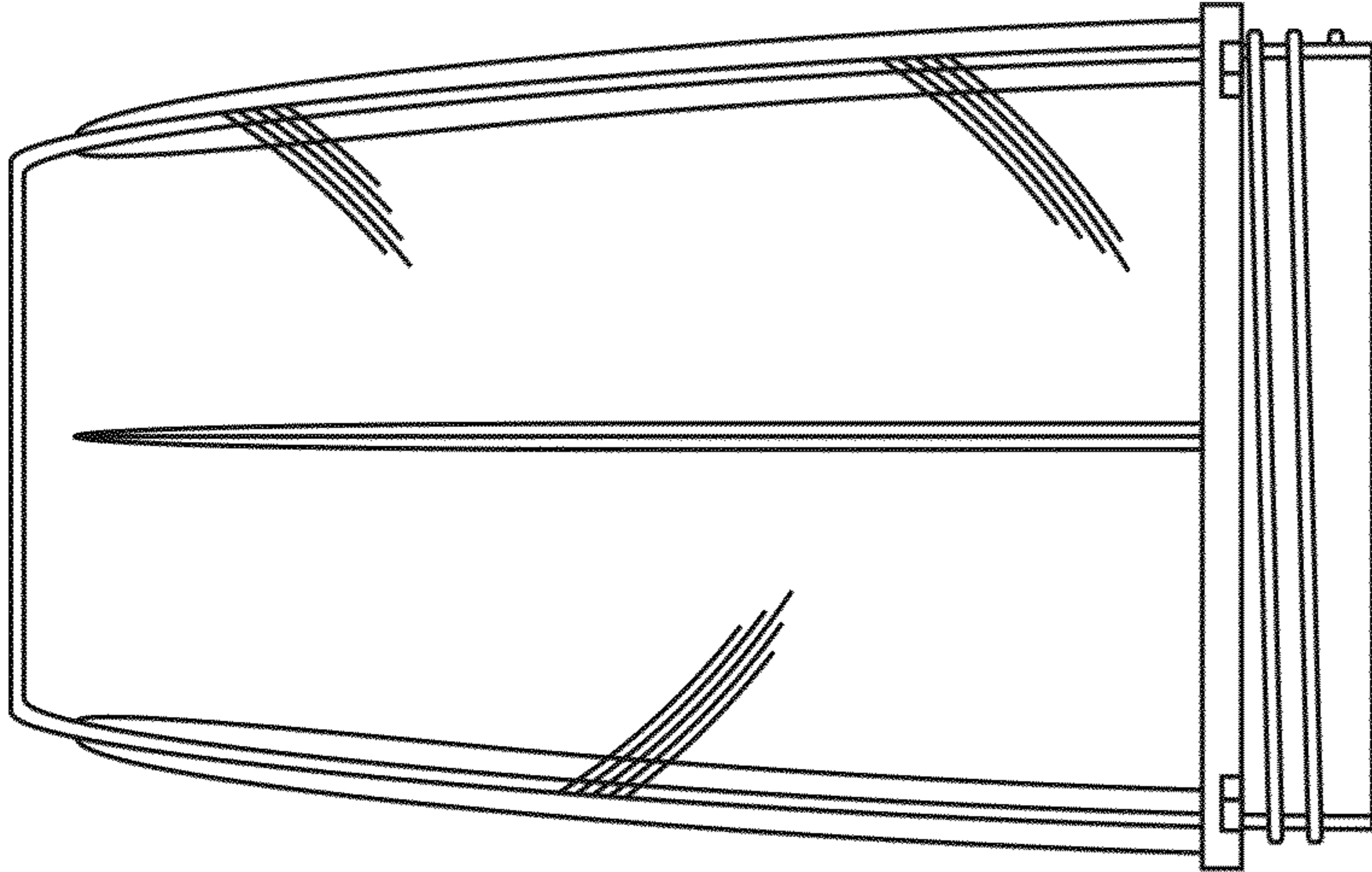

Fig. 3

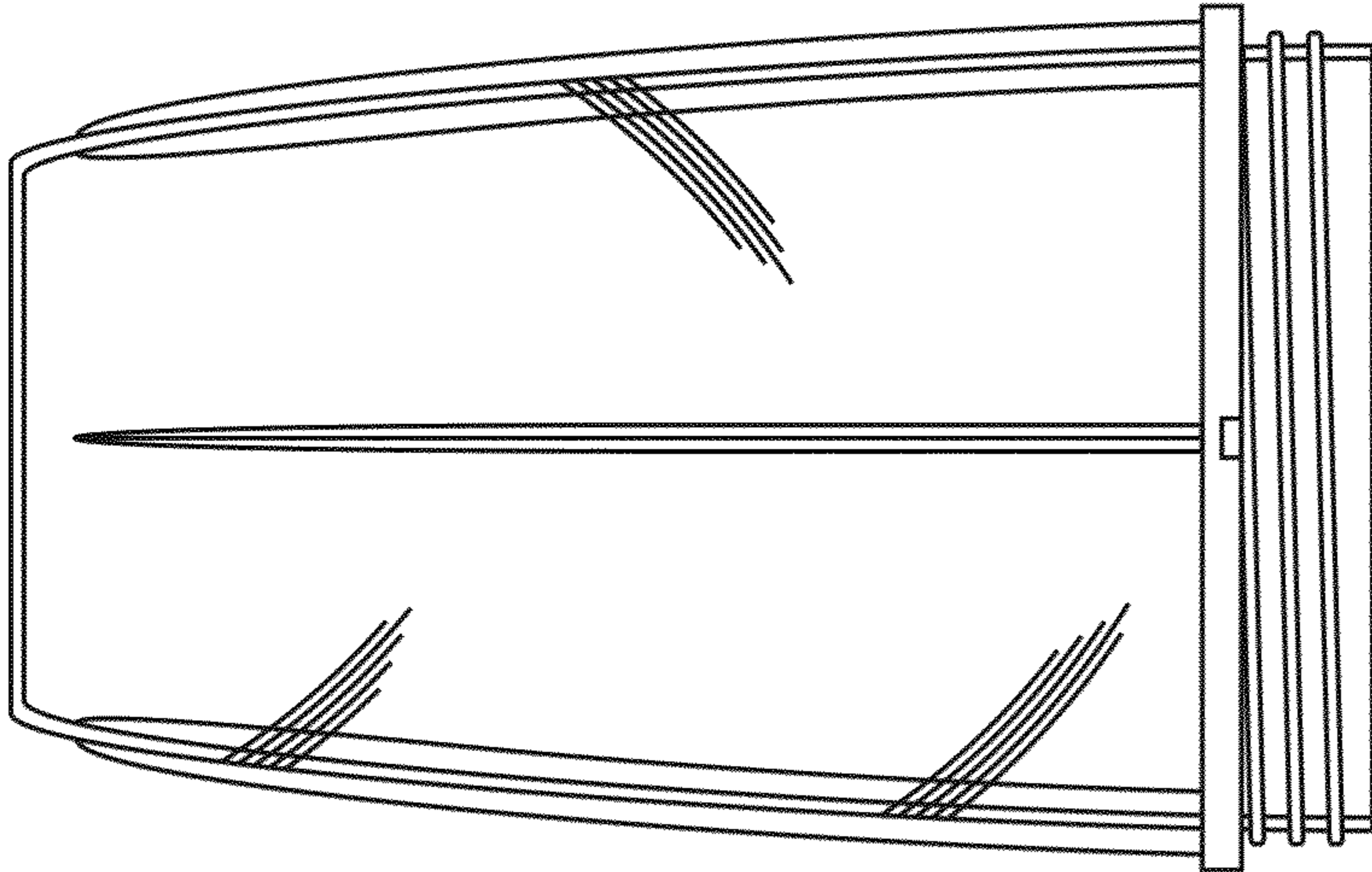

Fig. 4

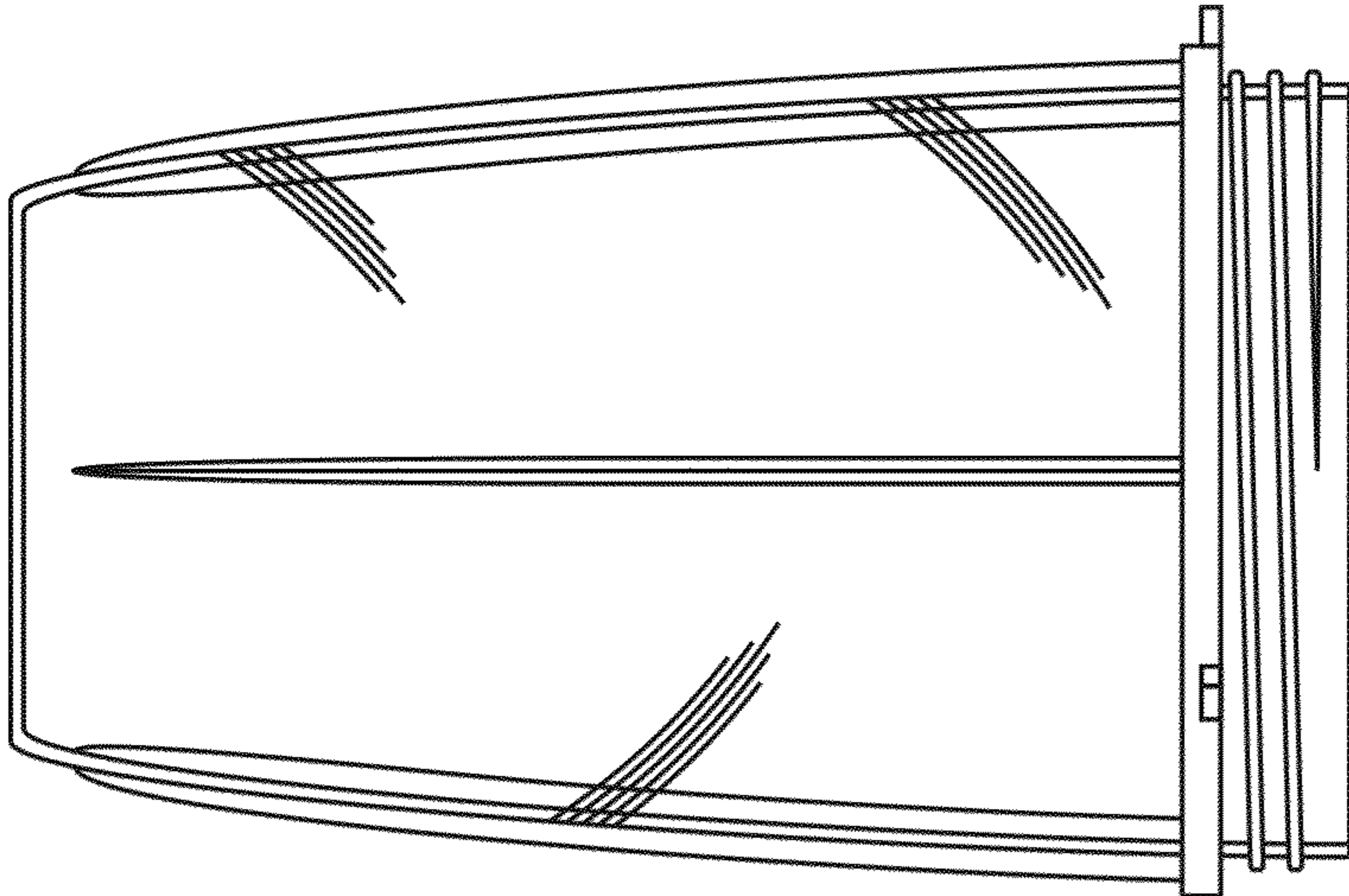

Fig. 5

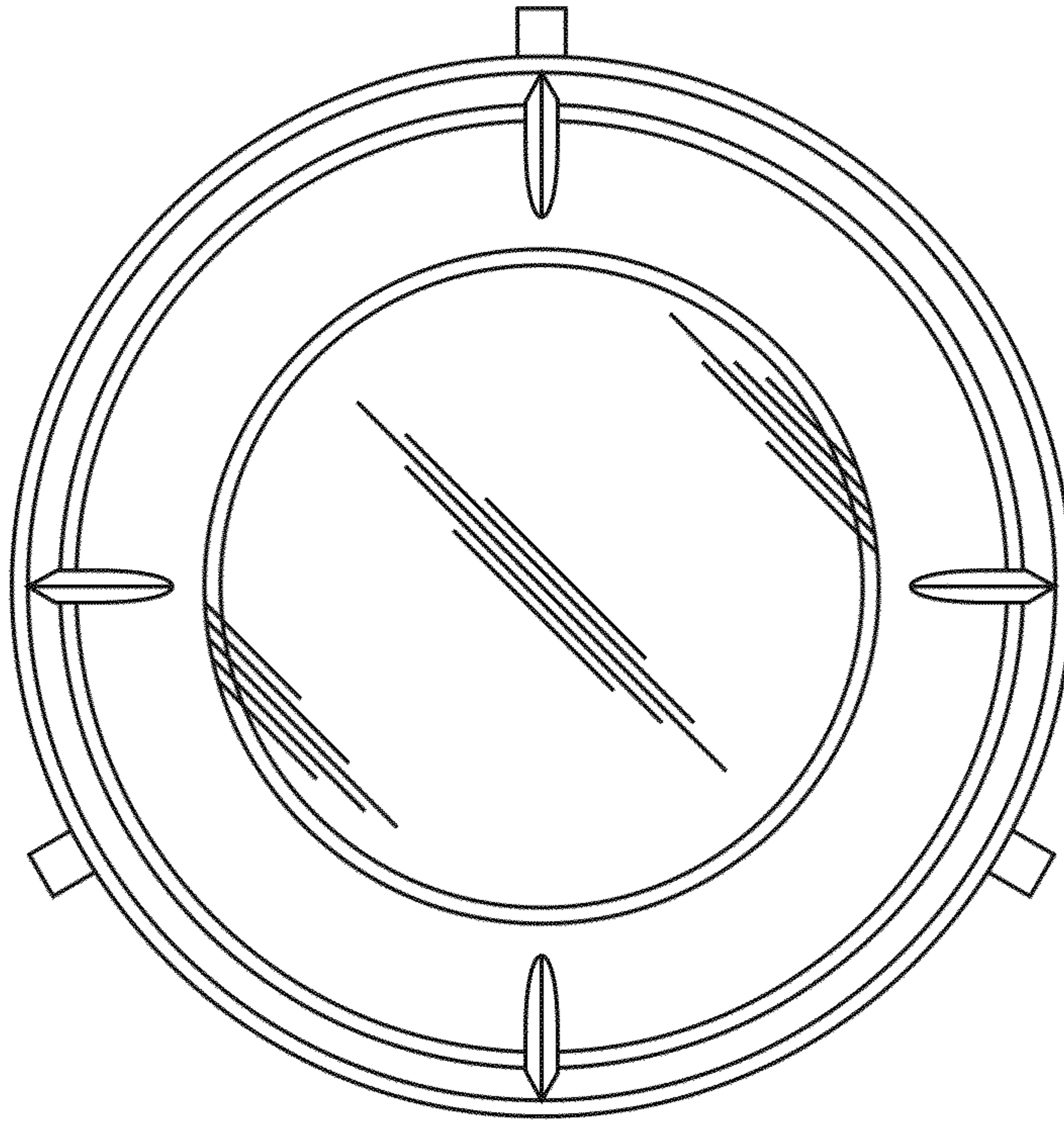

Fig. 7

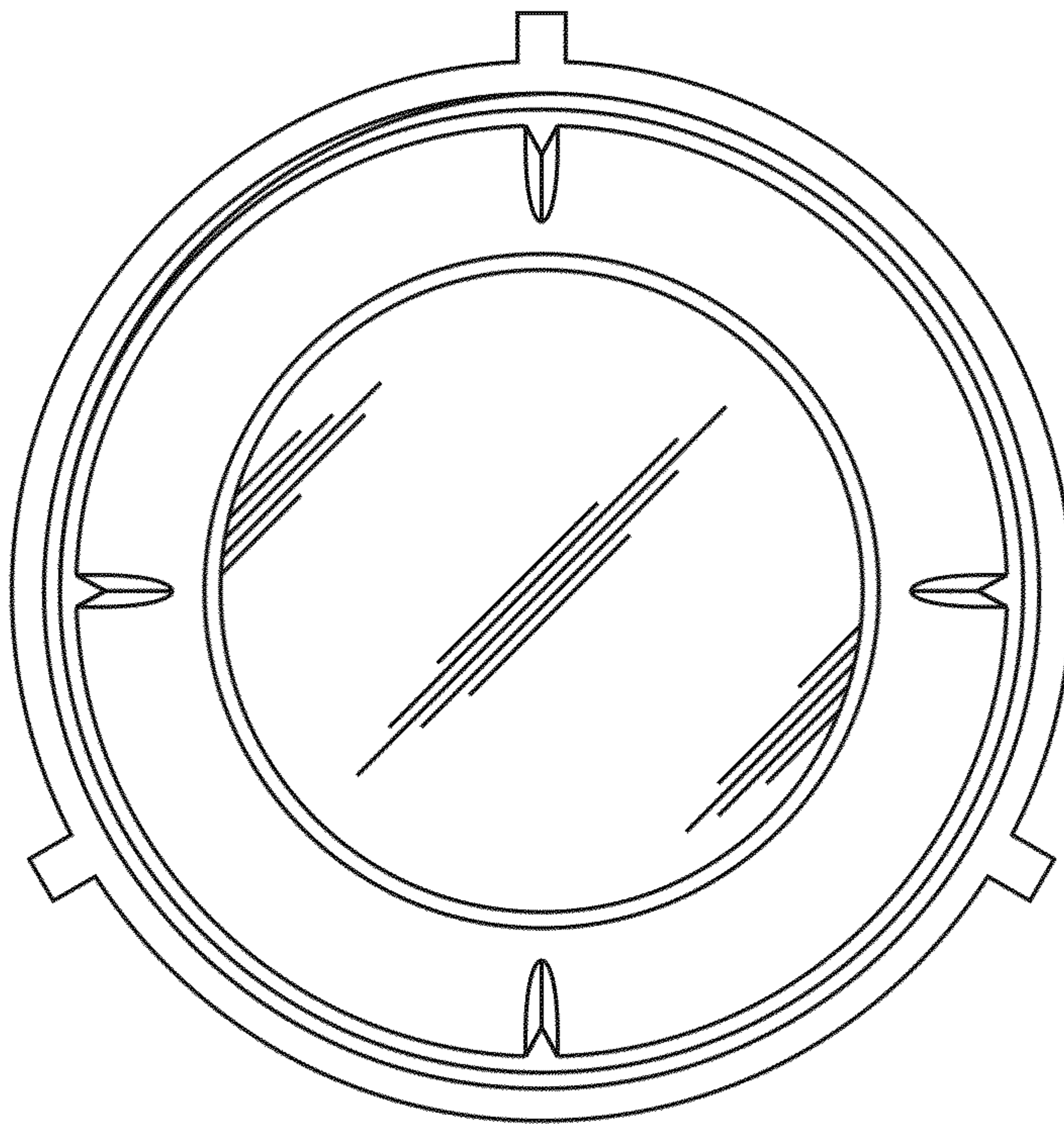

Fig. 6