



US00D737625S

(12) **United States Design Patent**
Caswell et al.

(10) **Patent No.:** **US D737,625 S**
(45) **Date of Patent:** **** Sep. 1, 2015**

(54) **COFFEE BEAN ROASTER**

(71) Applicant: **ROASTING PLANT, INC.**, New York, NY (US)

(72) Inventors: **Michael R. Caswell**, New York, NY (US); **Stephen A. Magliocco**, Fort Lauderdale, FL (US); **David Phillips**, Palm Beach Gardens, FL (US)

(73) Assignee: **ROASTING PLANT, INC.**, New York, NY (US)

(**) Term: **14 Years**

(21) Appl. No.: **29/476,465**

(22) Filed: **Dec. 13, 2013**

Related U.S. Application Data

(62) Division of application No. 29/432,703, filed on Sep. 19, 2012, now Pat. No. Des. 696,061, which is a division of application No. 29/388,969, filed on Apr. 5, 2011, now Pat. No. Des. 670,133.

(51) **LOC (10) Cl.** **31-00**

(52) **U.S. Cl.**

USPC **D7/373**; D7/372

(58) **Field of Classification Search**

USPC D7/338, 372, 373, 376-386, 665-666, D7/669, 678-679, 693-694; 99/501-513; 100/94-95, 98 R, 144, 147; 241/33-34, 241/36-37.5, 82.1, 82.4-82.5, 92-93, 100, 241/168-169, 273.1; 366/197, 204, 206, 366/251, 258, 274, 279, 341, 347

CPC A01F 2015/07; A01F 2015/077; A01F 2015/0775; A23N 1/00; A23N 1/02; A47J 19/00; A47J 19/005; A47J 19/02; A47J 19/04; A47J 19/06; A47J 42/32; A47J 42/34; A47J 42/36; A47J 43/044; A47J 43/0465; A47J 43/085; A47J 43/25; A47J 43/255; B01F 7/26; B01F 7/28; B01F 11/0082; B01F 13/04; B01F 13/0818; B02C 13/00; B02C 13/02;

B02C 13/10; B02C 18/06; B02C 18/26; B02C 18/30; B02C 18/302; B02C 18/304; B02C 18/305; B02C 25/00; B02C 2002/00; B02C 2013/00; B02C 2013/14; B02C 2013/145; B02C 2013/18; B02C 2013/1807; B02C 2013/1857; B02C 2013/1864; B30B 9/00; B30B 9/16; B30B 9/18; B30B 9/20; B30B 9/26; B30B 9/205; B30B 9/207

See application file for complete search history.

(56) **References Cited**

U.S. PATENT DOCUMENTS

3,138,370 A * 6/1964 Anderson et al. 366/274
3,384,353 A * 5/1968 Worth 366/274

(Continued)

Primary Examiner — Ricky Pham

(74) *Attorney, Agent, or Firm* — McCarter & English, LLP; David R. Burns

(57) **CLAIM**

The ornamental design for a coffee bean roaster, as shown and described.

DESCRIPTION

FIG. 1 is a front perspective view of a coffee bean roaster showing the design; FIG. 2 is a front elevational view of a coffee bean roaster showing the design; FIG. 3 is a rear elevational view of a coffee bean roaster showing the design; FIG. 4 is a left side elevational view of a coffee bean roaster showing the design; FIG. 5 is a right side elevational view of a coffee bean roaster showing the design; FIG. 6 is a top plan view of a coffee bean roaster showing the design; and, FIG. 7 is a bottom plan view of a coffee bean roaster showing the design.

1 Claim, 6 Drawing Sheets

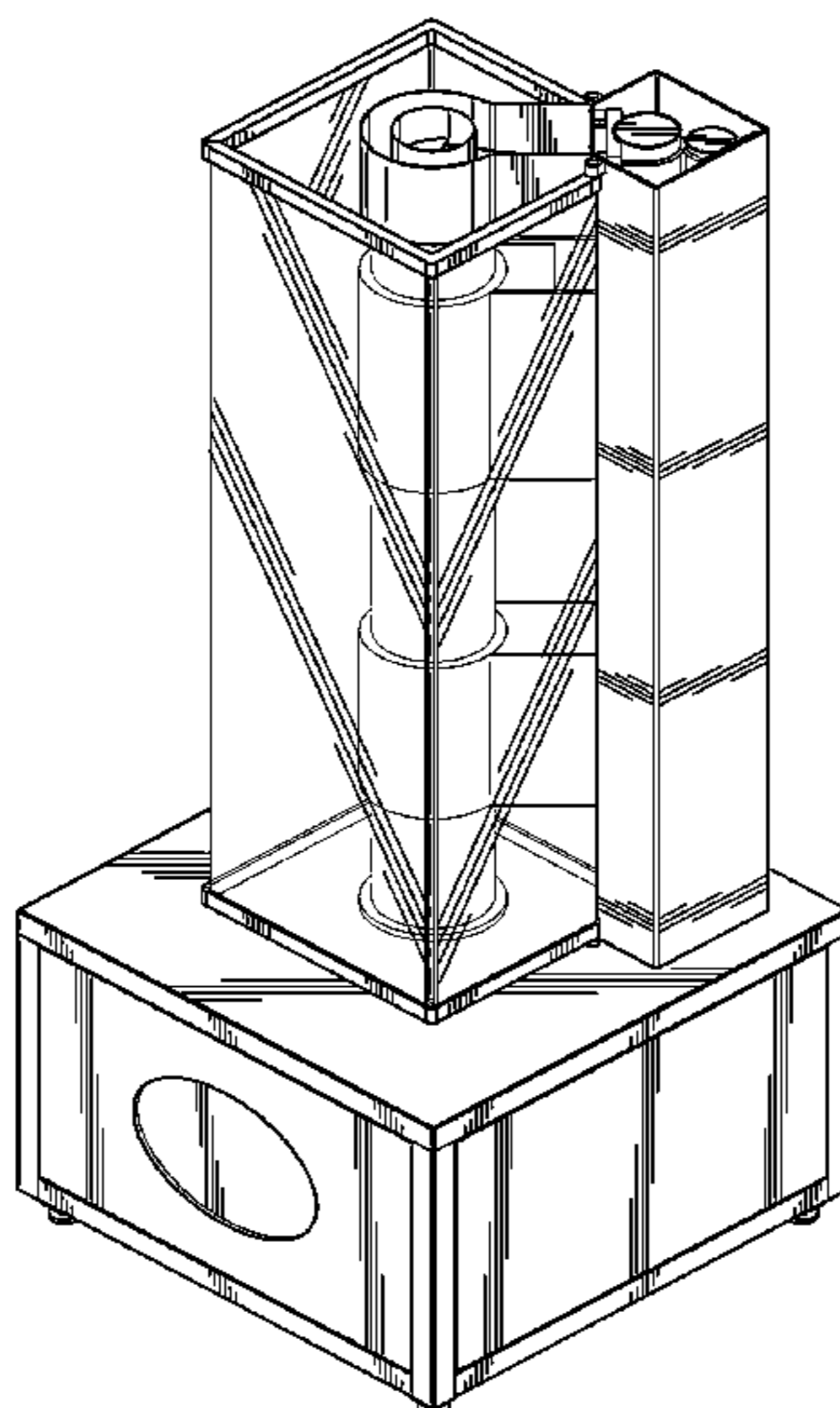

(56)

References Cited

U.S. PATENT DOCUMENTS

D228,485 S * 10/1973 Cabell D7/378
4,162,855 A * 7/1979 Bender 366/274
4,541,573 A * 9/1985 Fujiwara et al. 241/36
D281,945 S * 12/1985 Boyce D7/378

4,911,556 A * 3/1990 Lim et al. 366/279
D316,798 S * 5/1991 Munk D7/338
D400,048 S * 10/1998 Ollson D7/378
D637,862 S * 5/2011 Fouquet D7/378
D670,133 S * 11/2012 Caswell et al. D7/373
D696,061 S * 12/2013 Caswell et al. D7/373

* cited by examiner

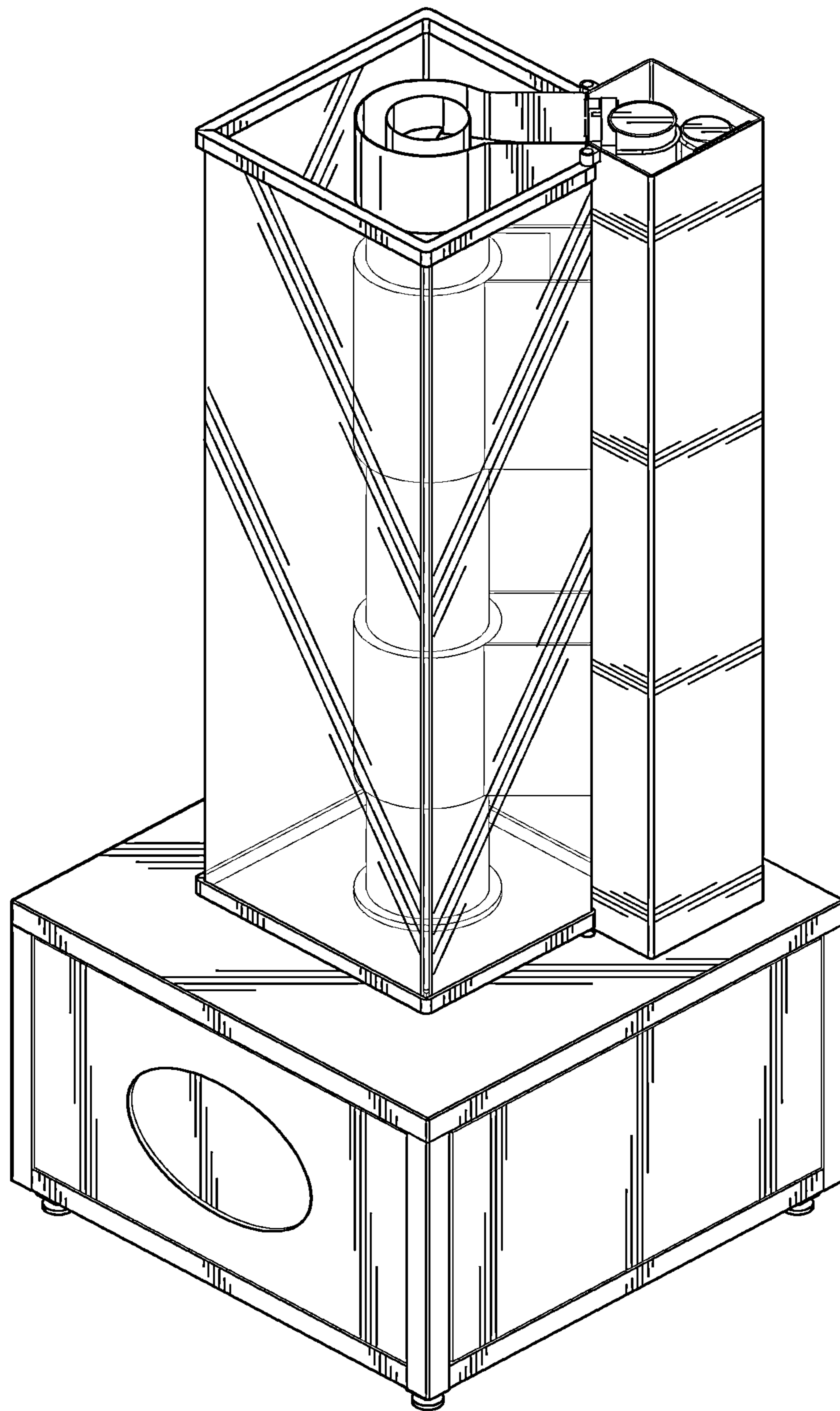

FIG. 1

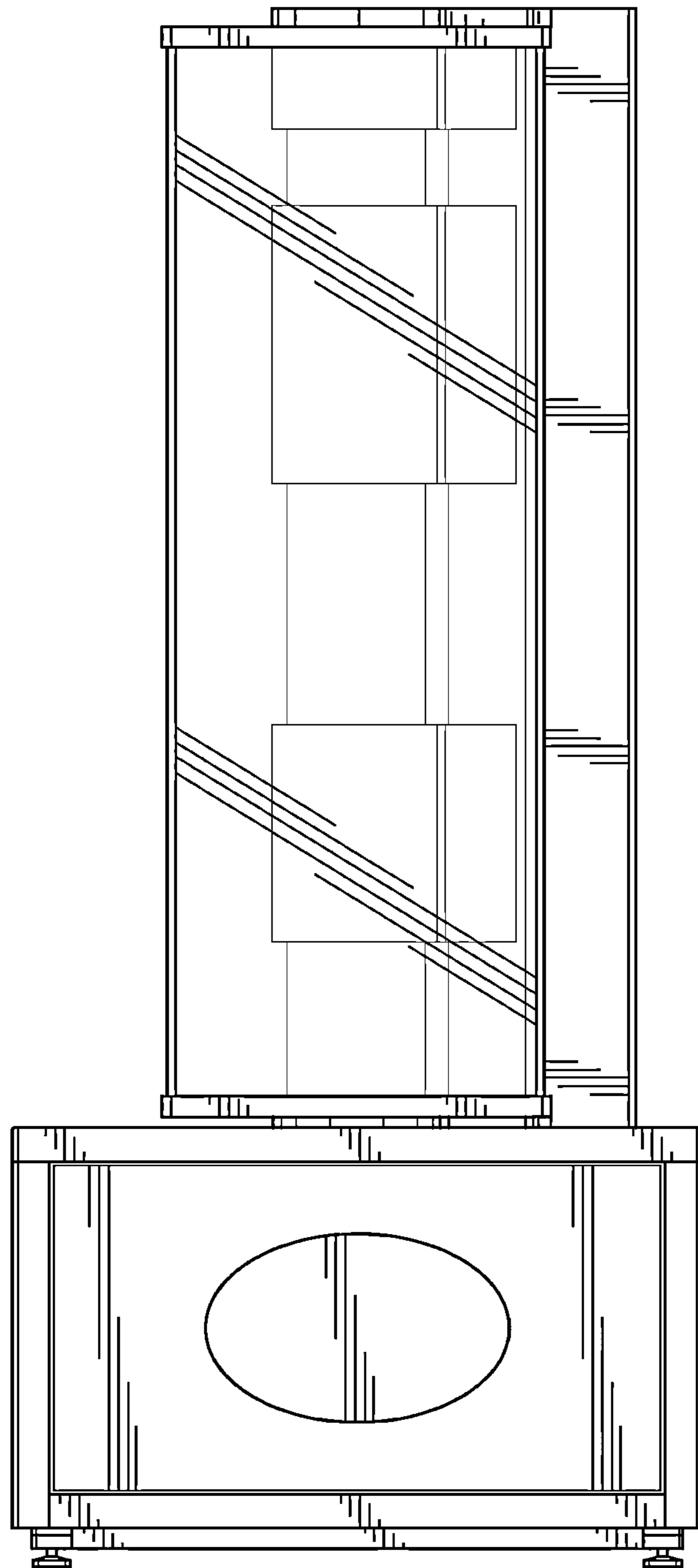

FIG. 2

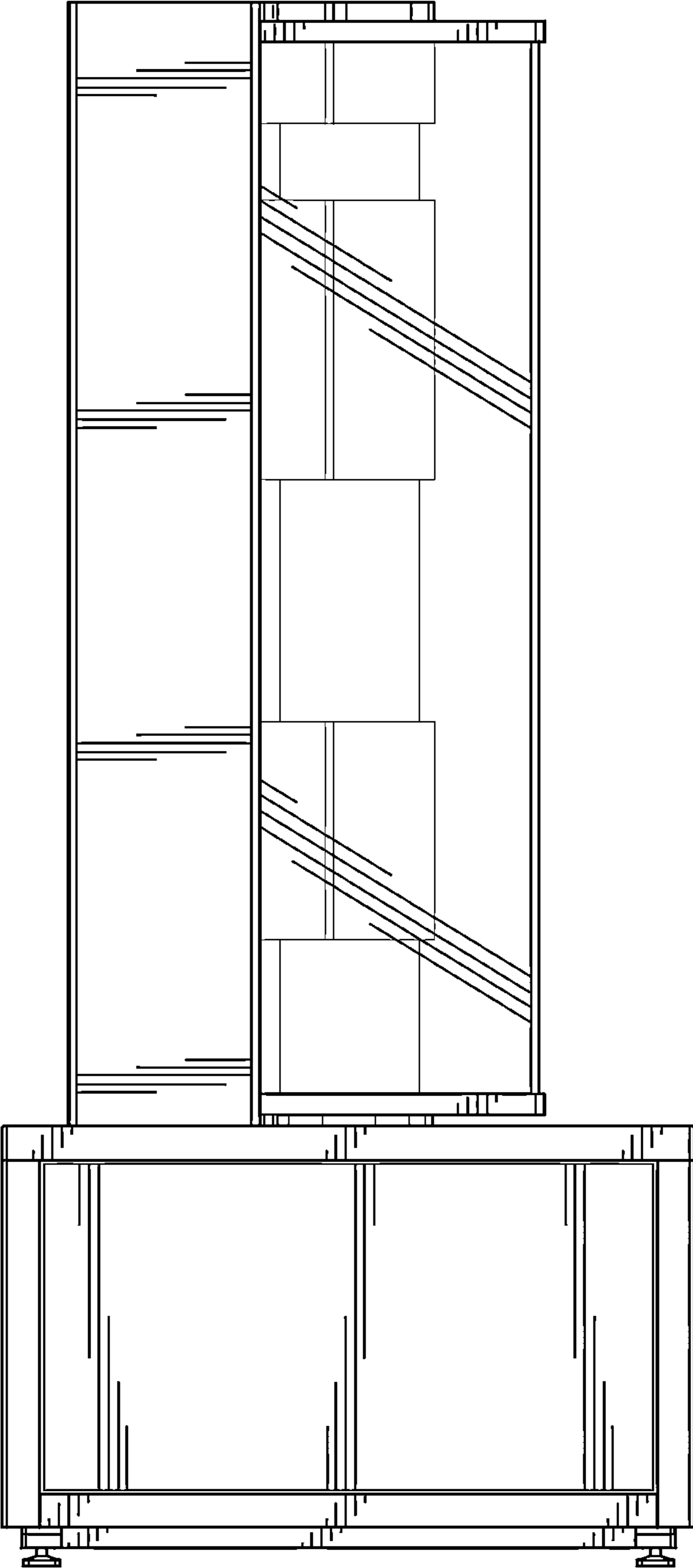

FIG. 3

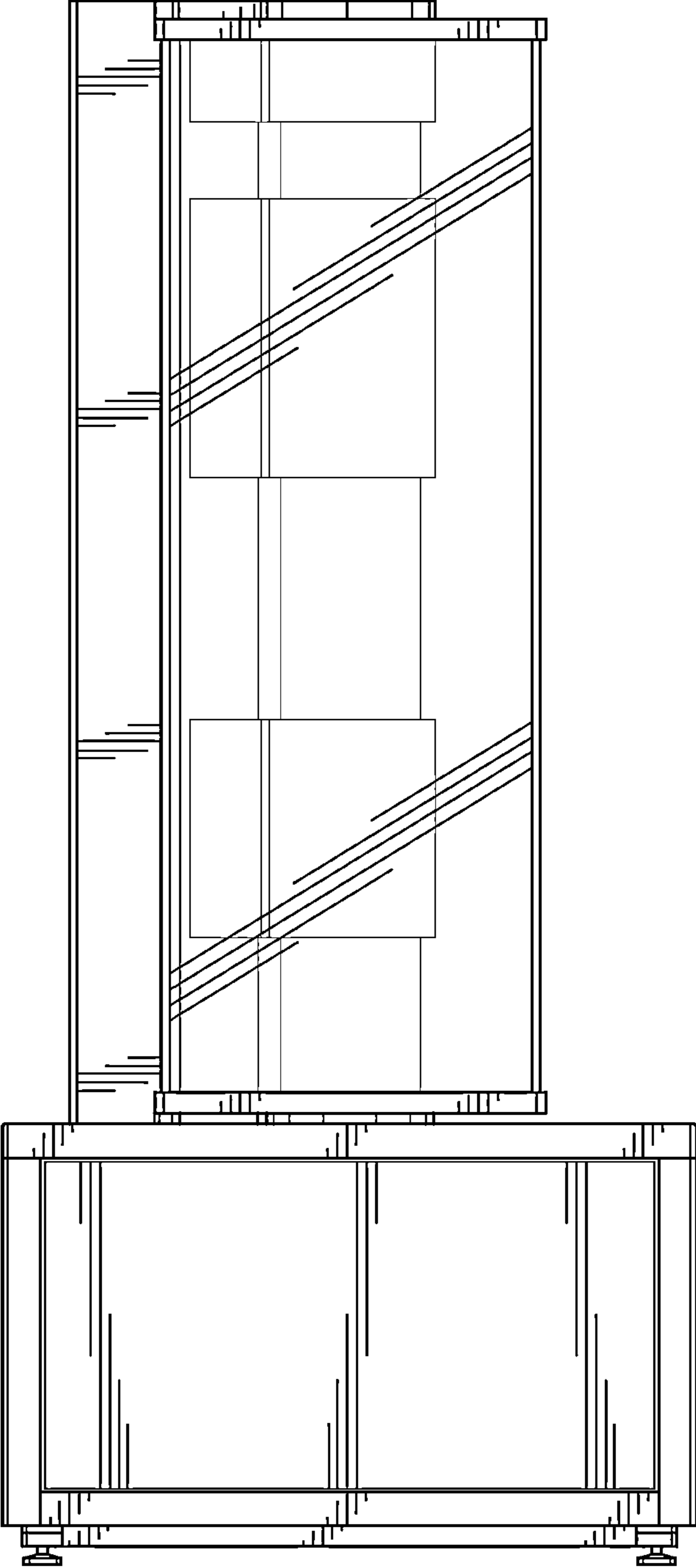

FIG. 4

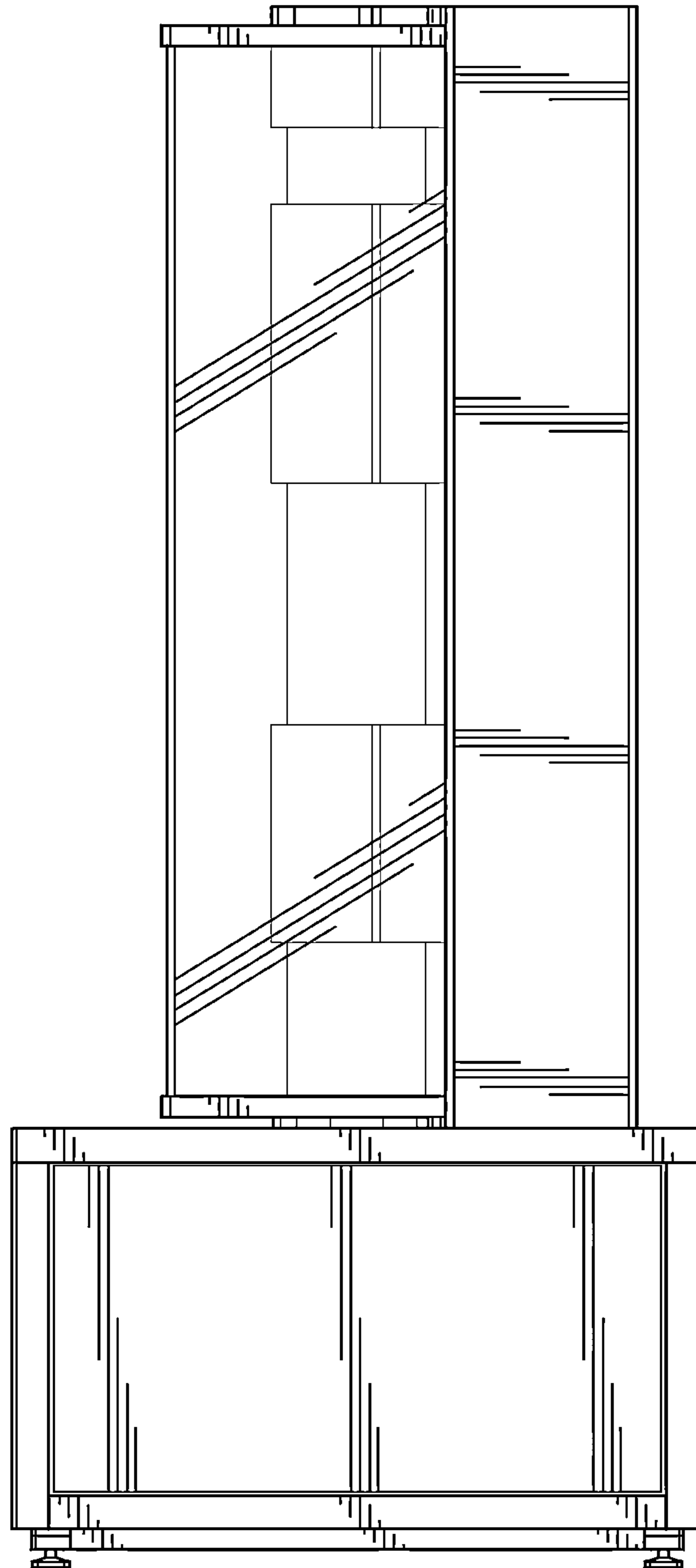

FIG. 5

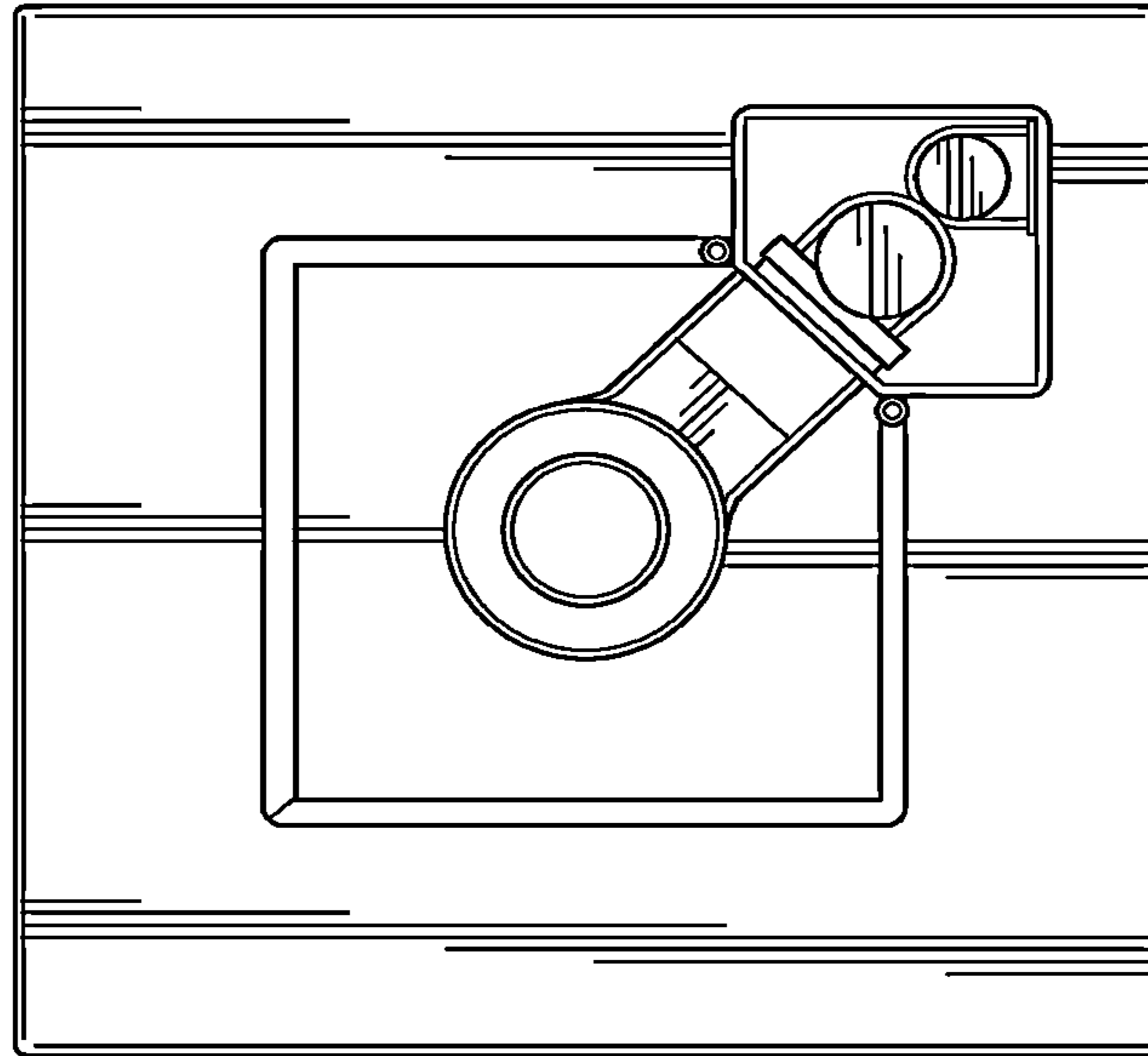

FIG. 6

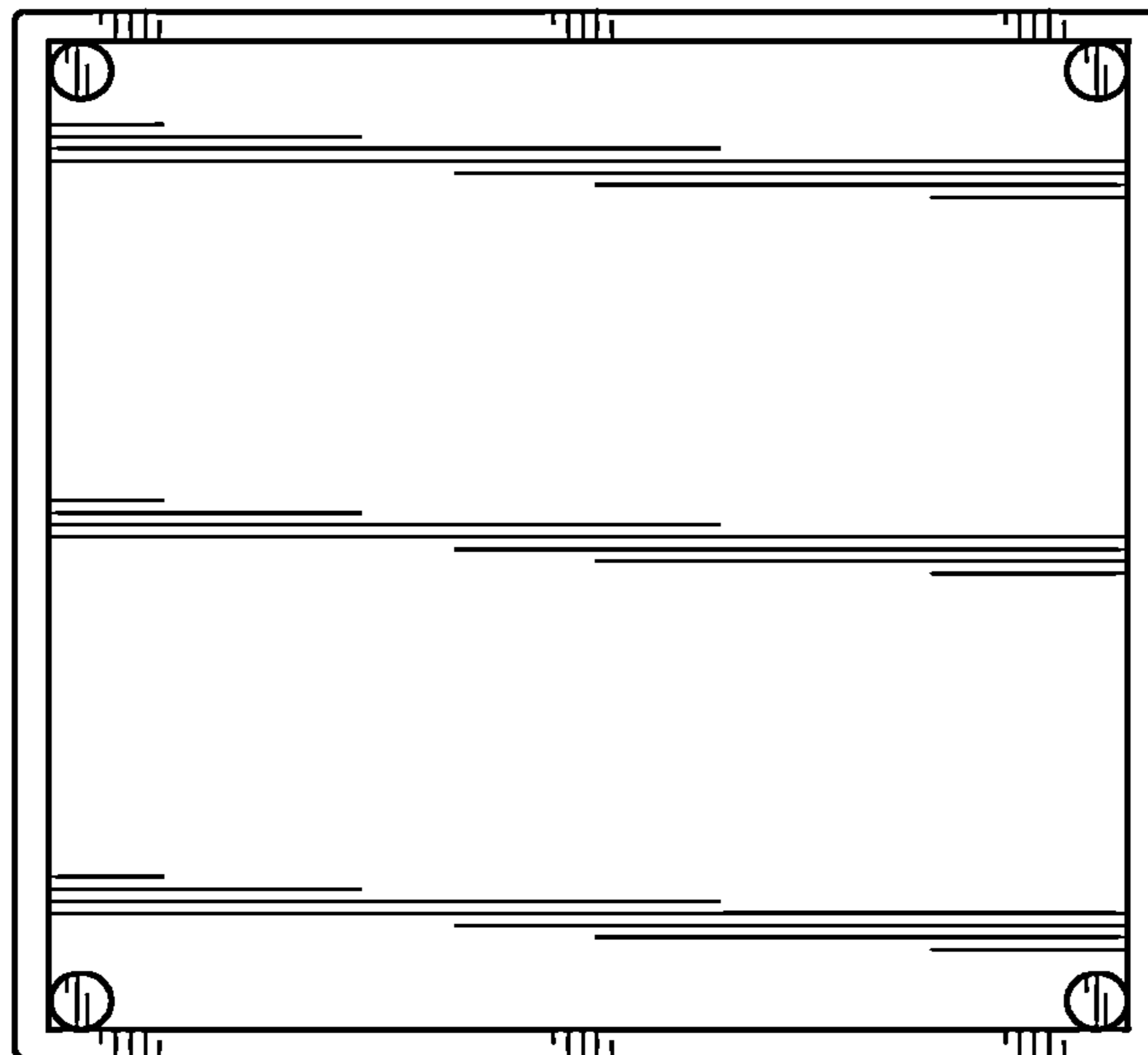

FIG. 7