

US00D737567S

(12) **United States Design Patent**  
**Roberts**

(10) **Patent No.:** **US D737,567 S**

(45) **Date of Patent:** **\*\* Sep. 1, 2015**

(54) **MODULAR BAG**

(71) Applicant: **Origin BJJ, LLC**, Industry, ME (US)

(72) Inventor: **Peter M. Roberts**, Industry, ME (US)

(73) Assignee: **Origin BJJ, LLC**, Industry, ME (US)

(\*\*) Term: **14 Years**

(21) Appl. No.: **29/472,470**

(22) Filed: **Nov. 12, 2013**

(51) **LOC (10) Cl.** ..... **03-01**

(52) **U.S. Cl.**

USPC ..... **D3/217**

(58) **Field of Classification Search**

USPC ..... D3/201, 213–218, 231, 232, 267, 273,  
D3/289, 290; 224/153, 155, 575, 578–579,  
224/581, 586, 613, 617, 627, 637, 644, 645,  
224/650, 653, 657; 206/320; 441/80

CPC ..... A45F 3/00; A45F 3/04; A45F 3/06  
See application file for complete search history.

(56) **References Cited**

**U.S. PATENT DOCUMENTS**

2,620,479	A	12/1952	Buck
2,982,105	A	5/1961	Akers
3,061,057	A	10/1962	Miller
3,122,225	A	2/1964	Ward
3,357,613	A	12/1967	Chase
3,443,671	A	5/1969	Dyke
3,831,651	A	8/1974	Leahy
4,018,369	A	4/1977	Jaeger
4,081,061	A	3/1978	Tucker
4,236,657	A	12/1980	Brunton
4,318,502	A	3/1982	Lowe et al.
4,491,258	A	1/1985	Jones
4,778,091	A	10/1988	Barto
4,793,534	A	12/1988	Berry
5,014,359	A	5/1991	Hanson
5,050,998	A	9/1991	Wachtel
5,184,763	A	2/1993	Blaisdell et al.

(Continued)

*Primary Examiner* — Michael A Pratt

(74) *Attorney, Agent, or Firm* — Dennis R. Haszko

(57) **CLAIM**

The ornamental design for a modular bag, as shown and described.

**DESCRIPTION**

FIG. 1 is a perspective view of the modular bag including a large bag and small bag whereby the large bag and small bag are used in combination;

FIG. 2 is a front view of the large bag in use independent of the small bag;

FIG. 3 is a rear view of the large bag in use independent of the small bag;

FIG. 4 is a right side view of the large bag in use independent of the small bag;

FIG. 5 is a left side view of the large bag in use independent of the small bag;

FIG. 6 is a top view of the large bag in use independent of the small bag;

FIG. 7 is a bottom view of the large bag in use independent of the small bag;

FIG. 8 is a front view of the small bag in use independent of the large bag;

FIG. 9 is a rear view of the small bag in use independent of the large bag;

FIG. 10 is a right side view of the small bag in use independent of the large bag;

FIG. 11 is a left side view of the small bag in use independent of the large bag;

FIG. 12 is a top view of the small bag in use independent of the large bag; and,

FIG. 13 is a bottom view of the small bag in use independent of the large bag.

The portions shown in broken lines do not form part of the design.

**1 Claim, 13 Drawing Sheets**

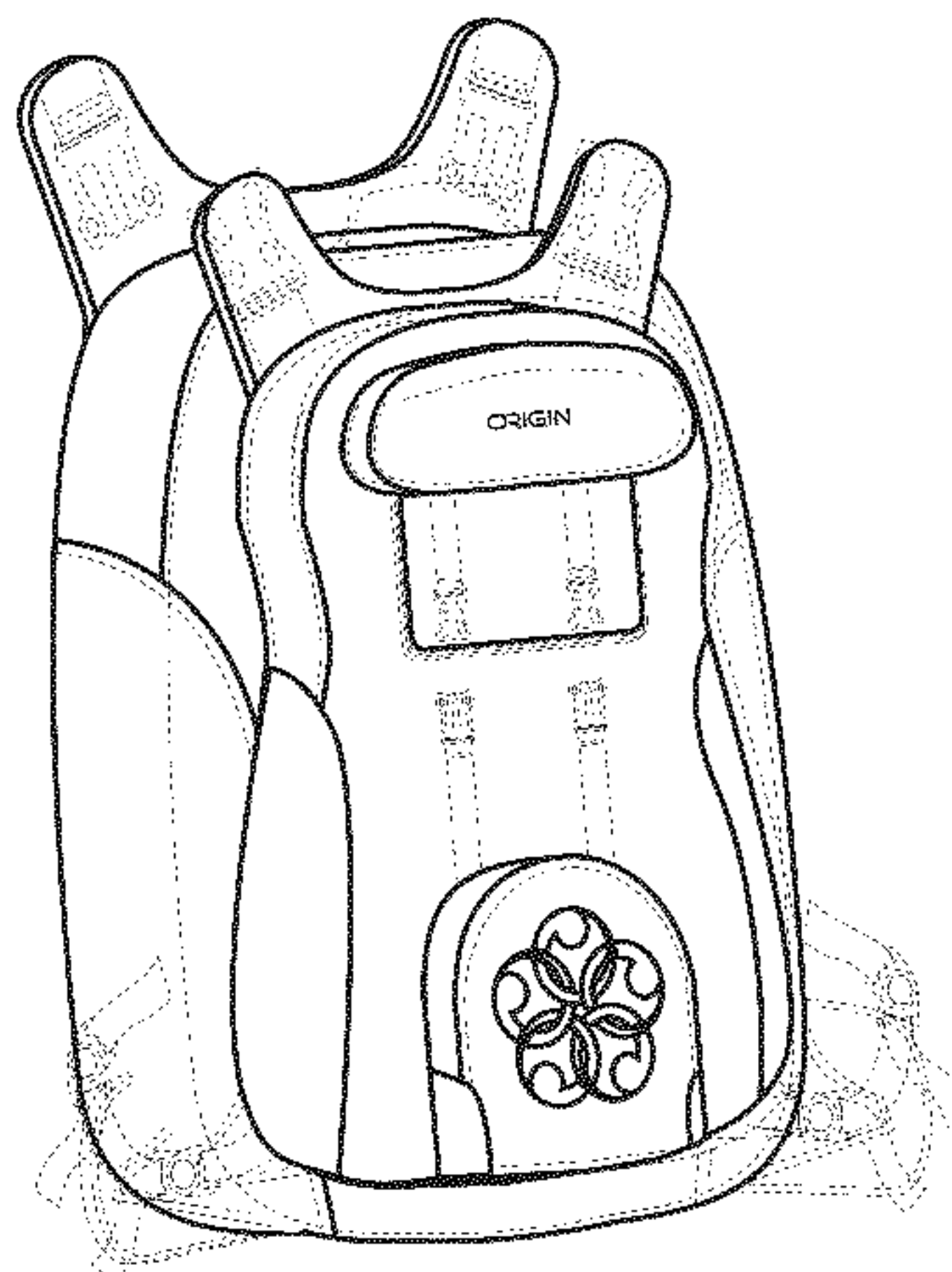

(56)

**References Cited**

U.S. PATENT DOCUMENTS

5,249,890 A 10/1993 Bergstrom  
5,292,044 A 3/1994 Reimers  
D352,165 S 11/1994 Covertson  
5,361,955 A 11/1994 Gregory  
5,564,612 A 10/1996 Gregory  
5,634,579 A 6/1997 Baclawski  
5,639,005 A 6/1997 Chouinard  
5,704,528 A 1/1998 Faure  
5,934,527 A 8/1999 Von Neumann

6,189,750 B1 2/2001 Von Neumann  
6,837,409 B2 1/2005 Lemanski, II  
D642,791 S \* 8/2011 Quehl ..... D3/217  
D665,573 S \* 8/2012 Crandall ..... D3/217  
8,534,523 B2 9/2013 Murdoch et al.  
D699,431 S \* 2/2014 Hock ..... D3/216  
2002/0185508 A1 \* 12/2002 Clark et al. .... 224/652  
2009/0127299 A1 \* 5/2009 Jamlang ..... 224/153  
2010/0213892 A1 \* 8/2010 DeSanctis ..... 320/107  
2010/0237110 A1 \* 9/2010 Hunter ..... 224/155  
2010/0243692 A1 \* 9/2010 Sabbah ..... 224/581

\* cited by examiner

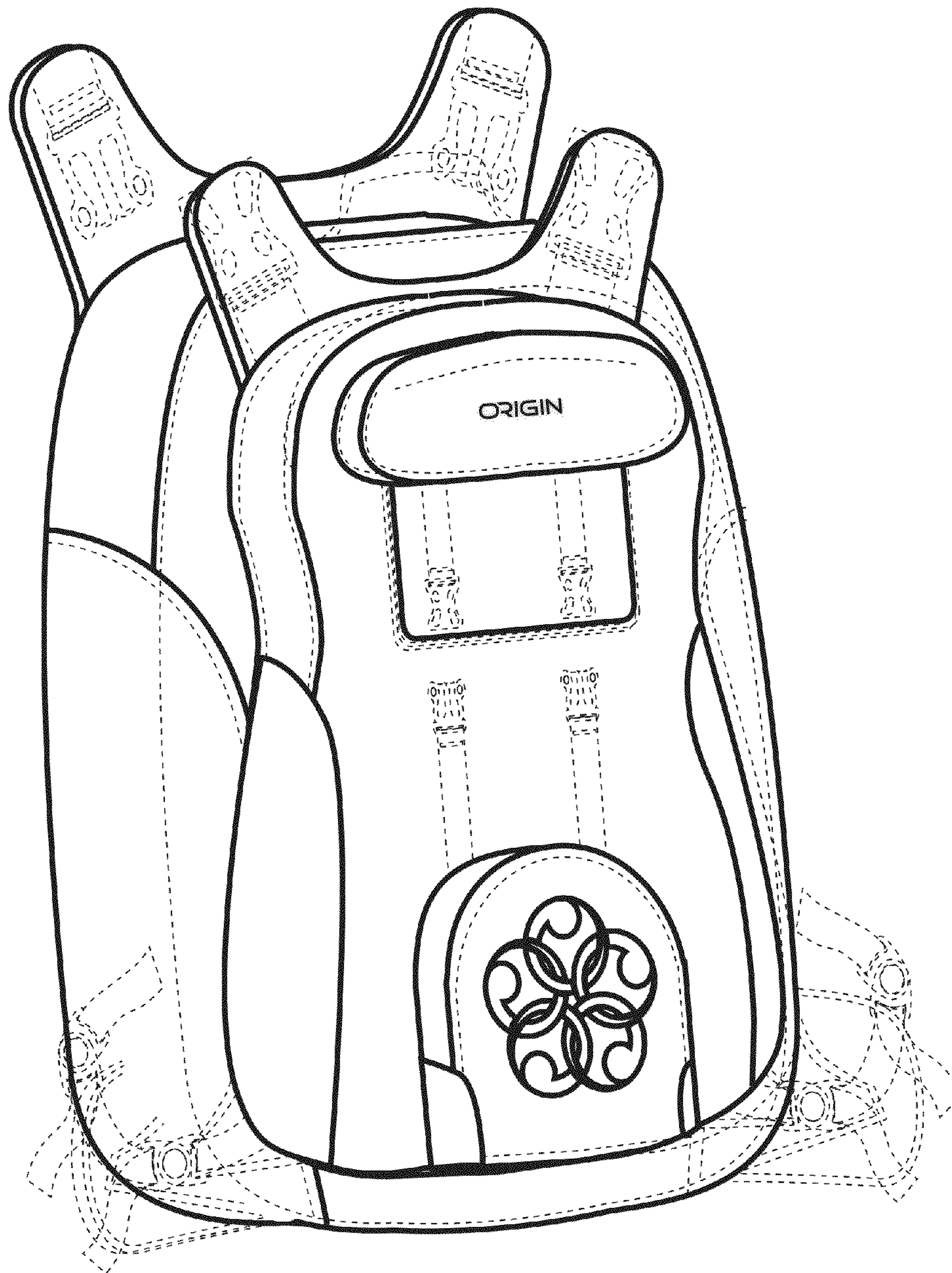

FIGURE 1.





FIGURE 2.

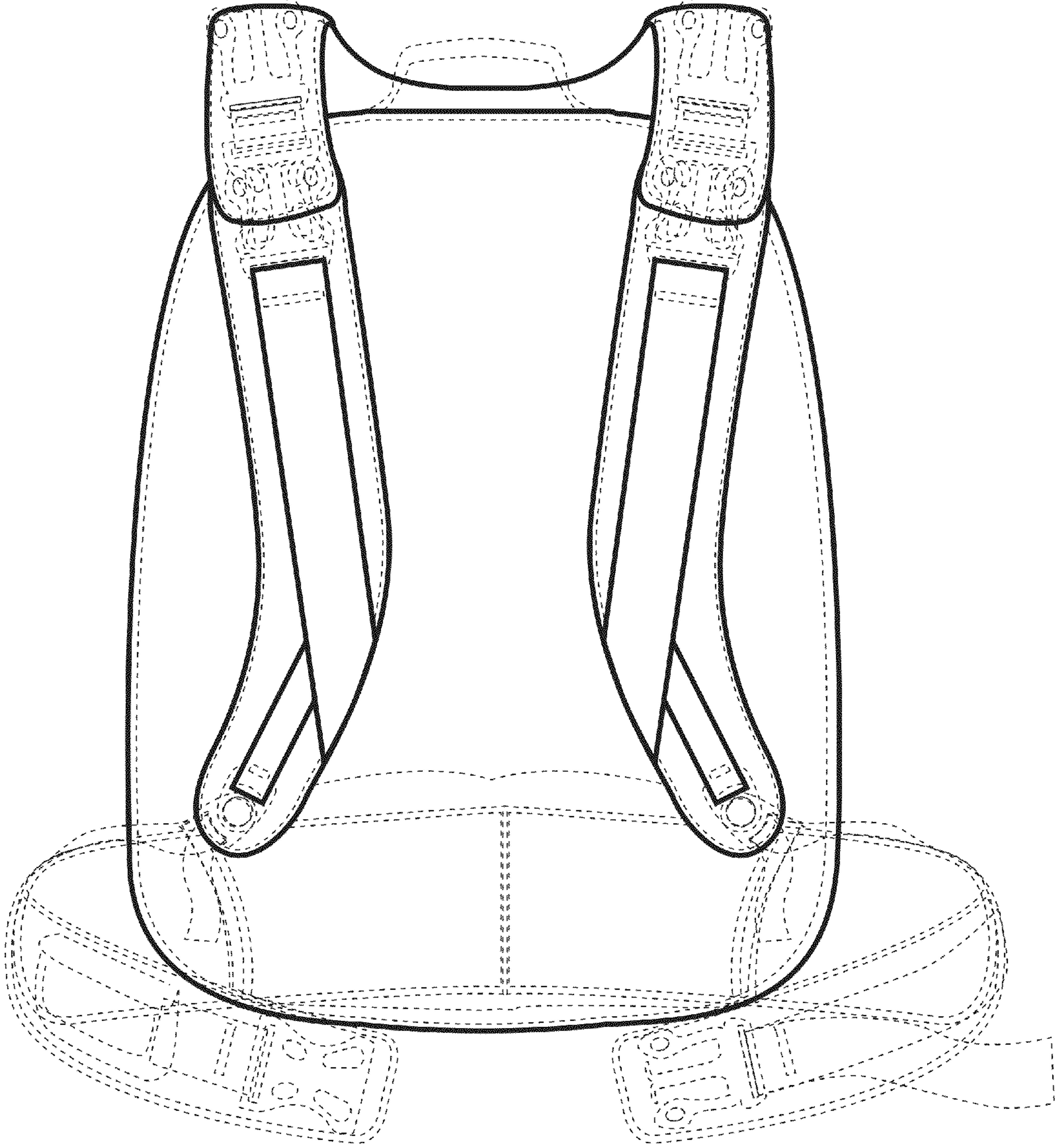

FIGURE 3.

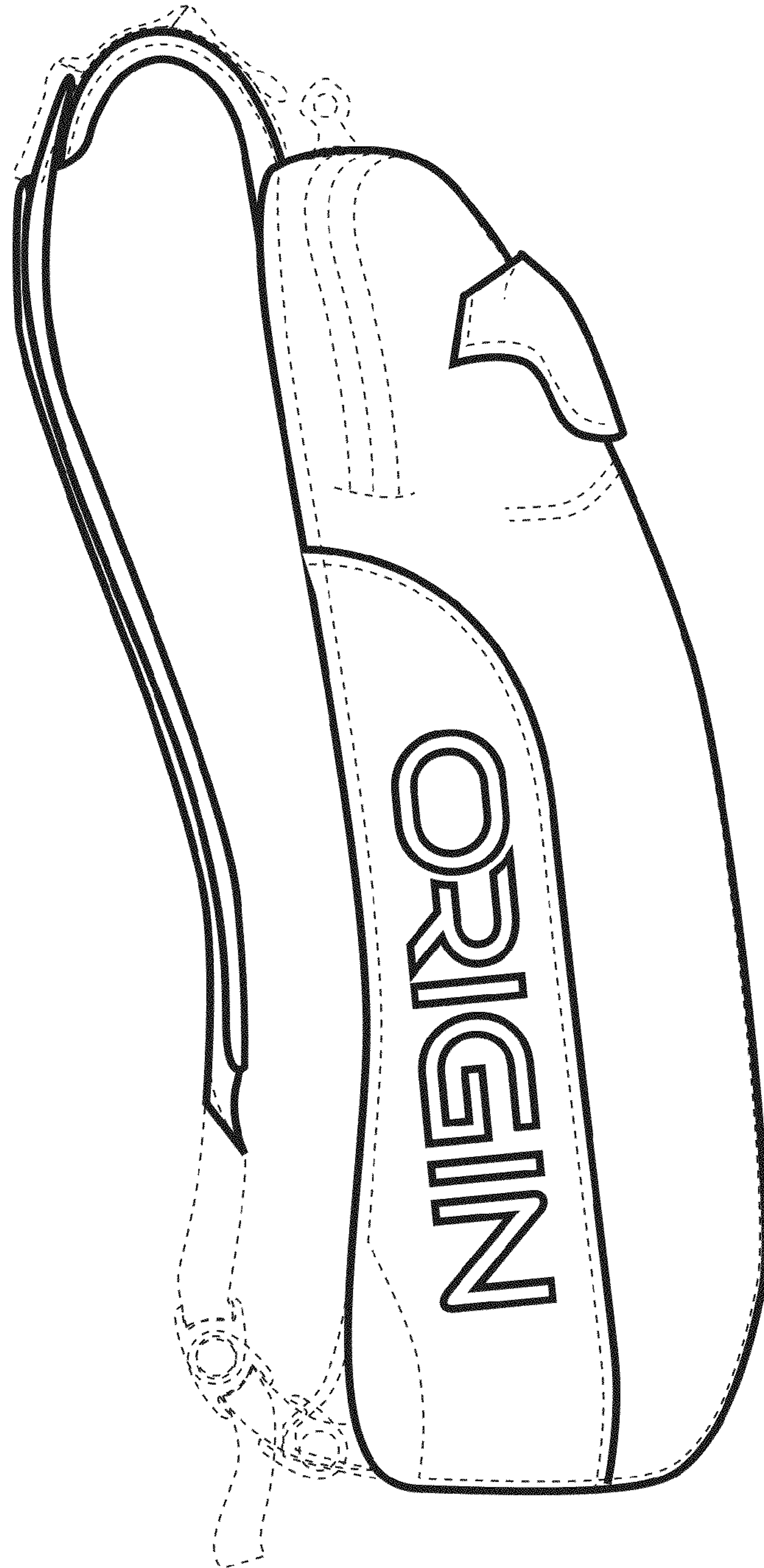

FIGURE 4.



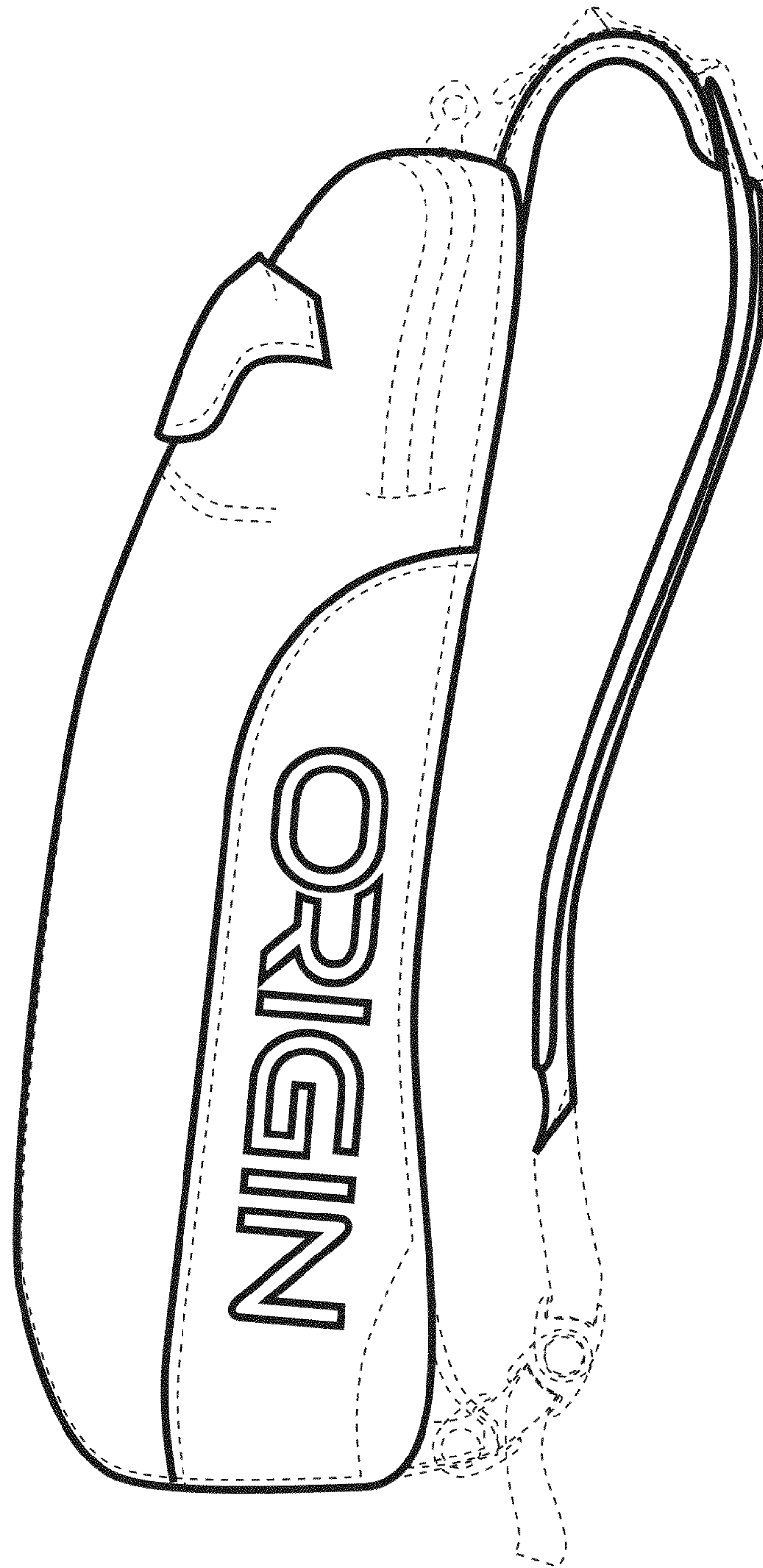

FIGURE 5.

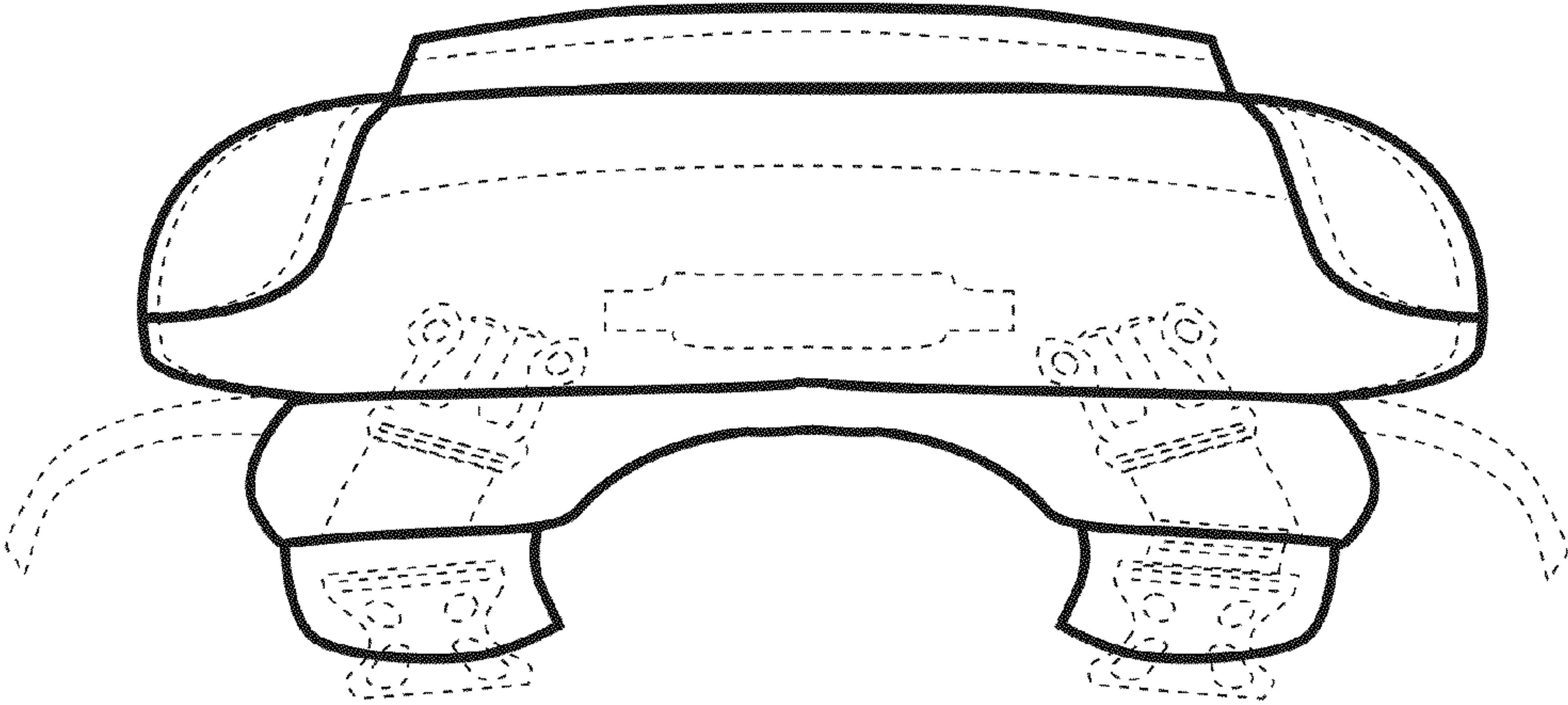

FIGURE 6.



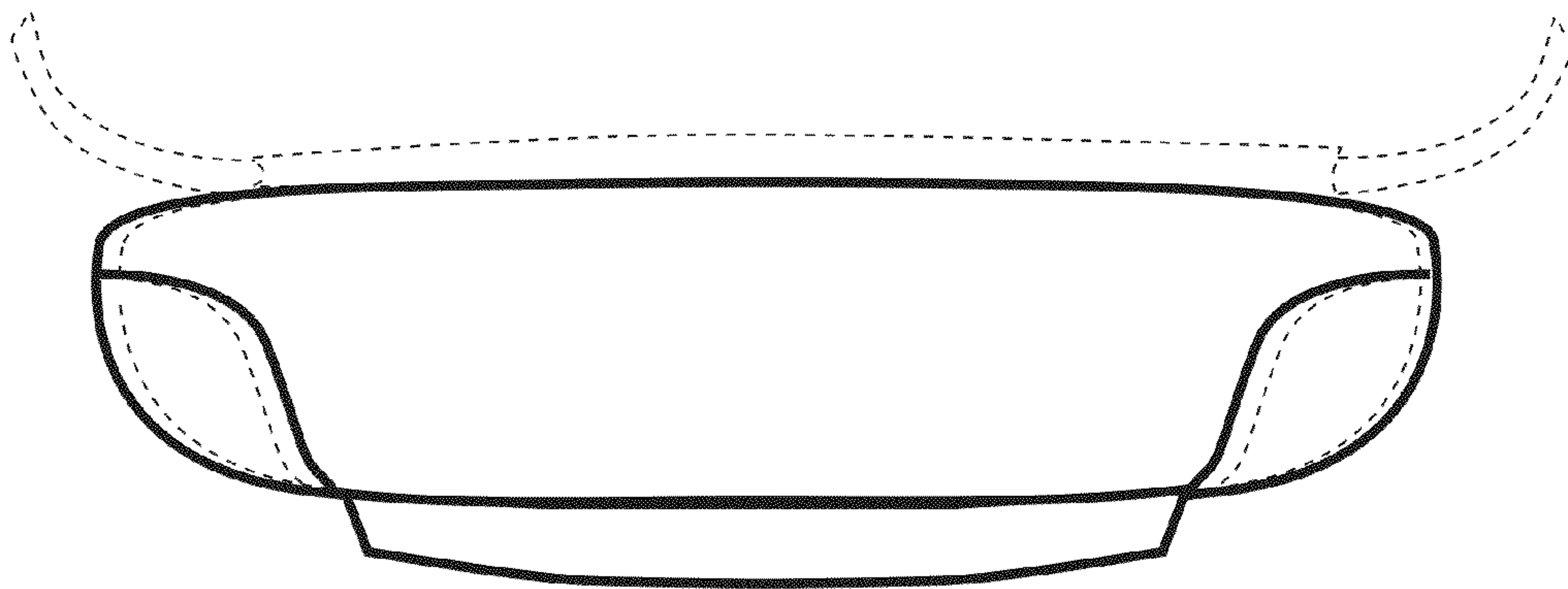

FIGURE 7.

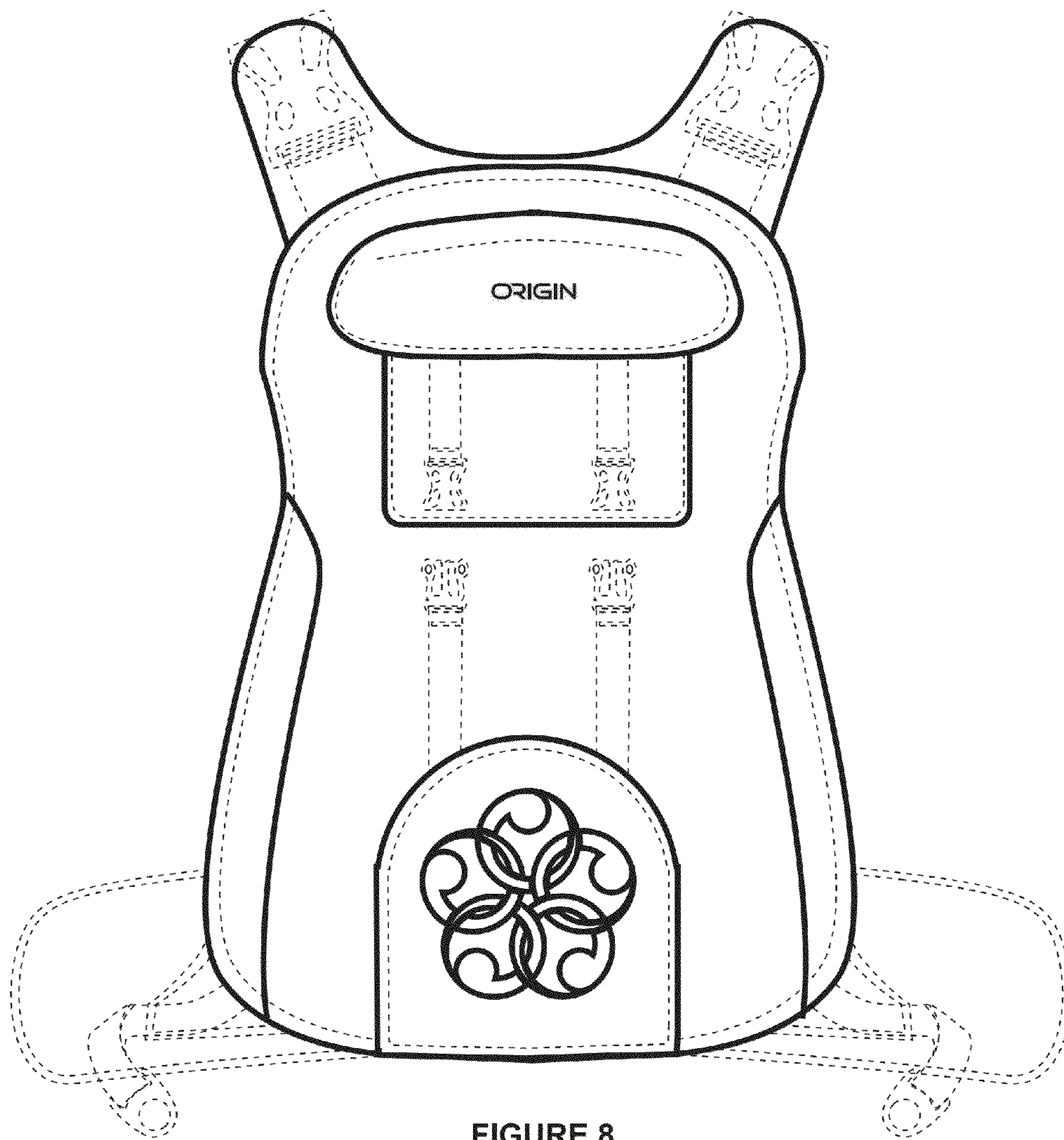

FIGURE 8

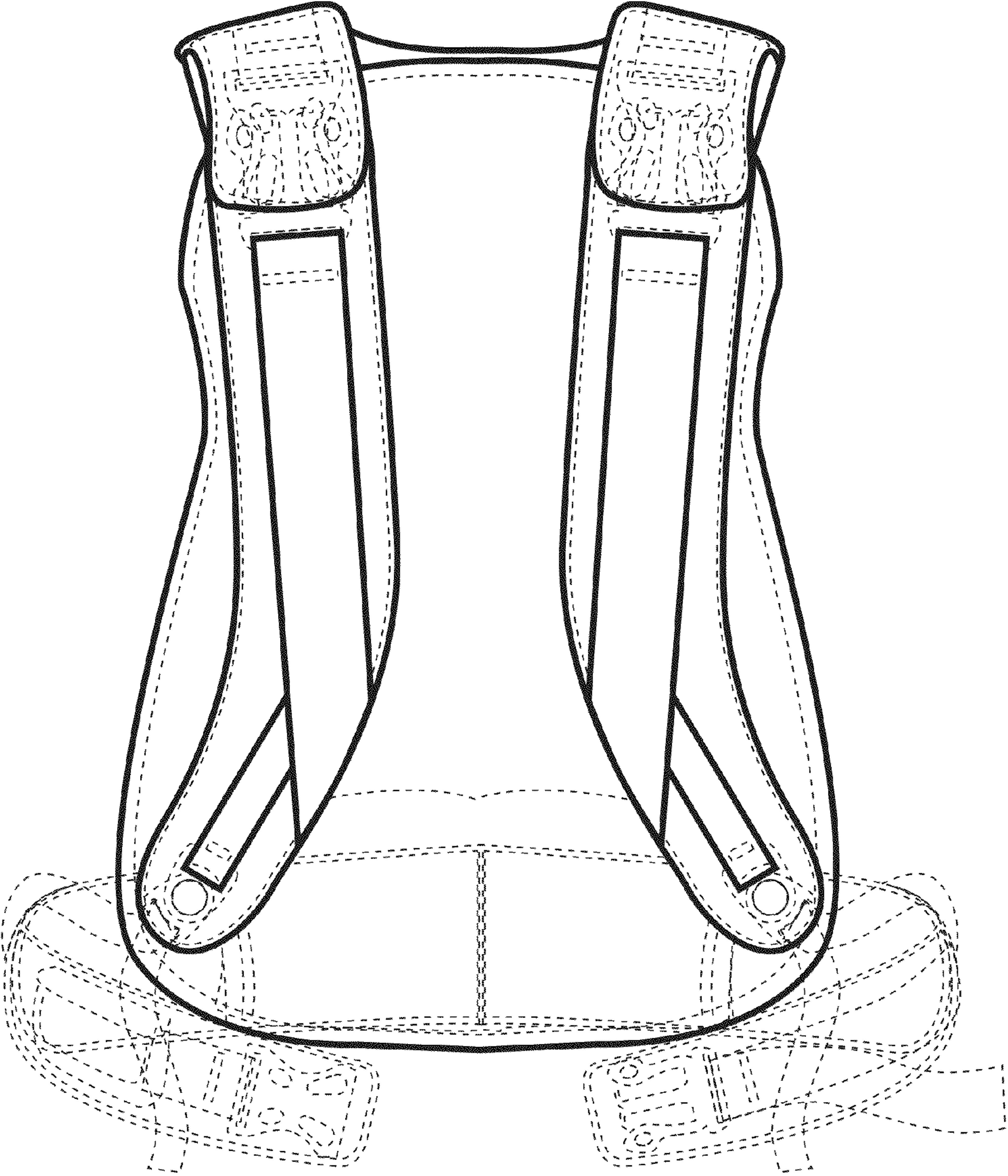

FIGURE 9



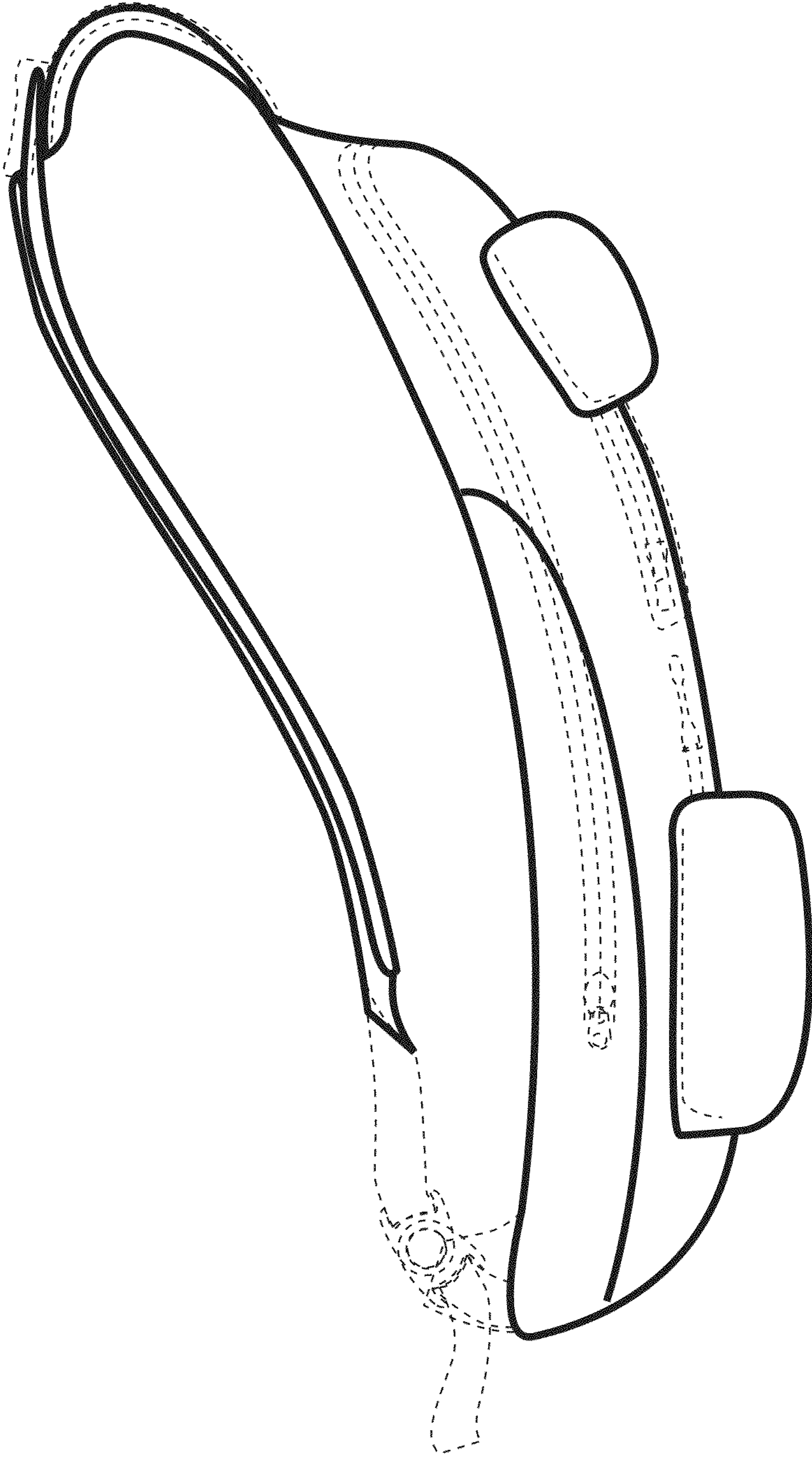

FIGURE 10.

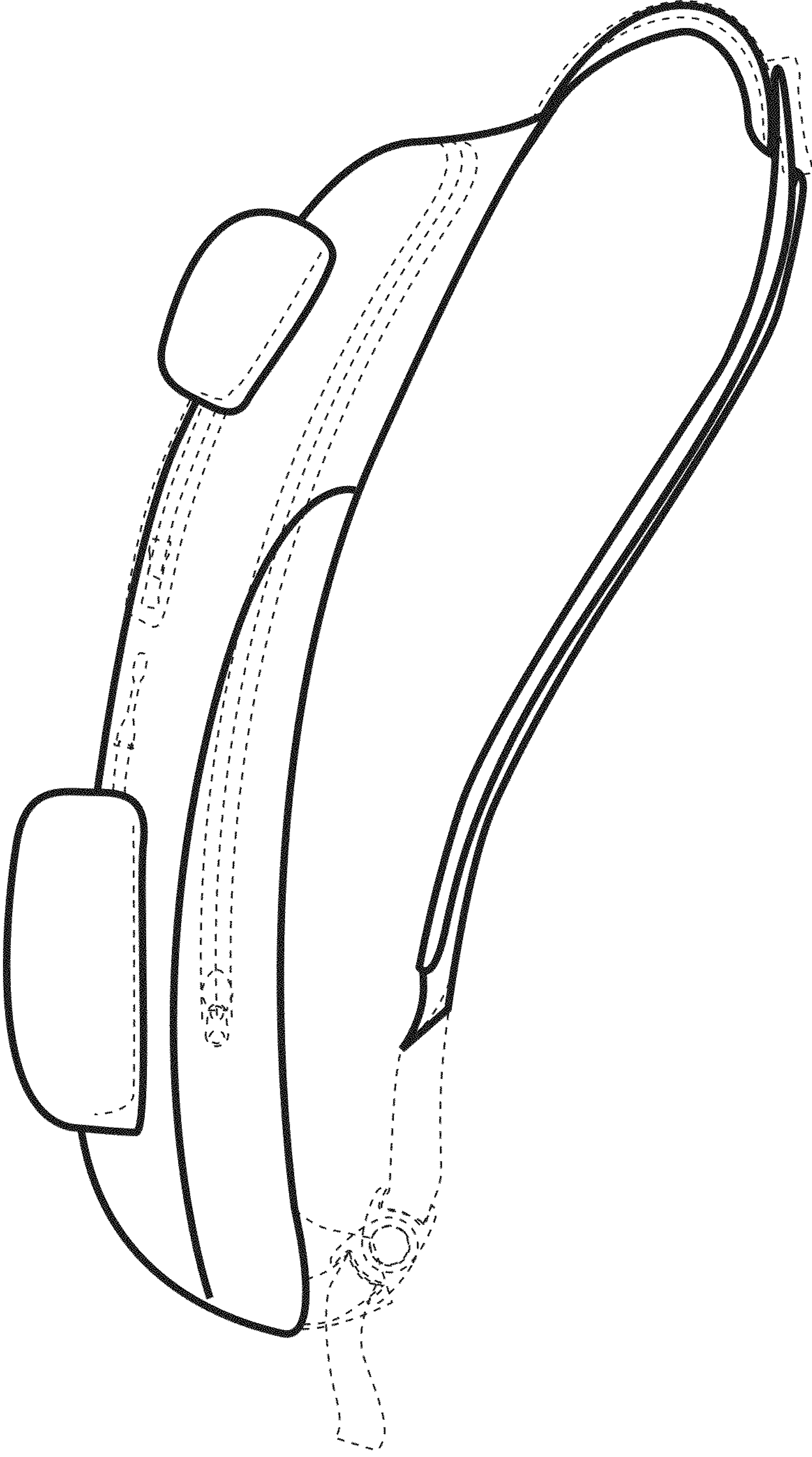

FIGURE 11.

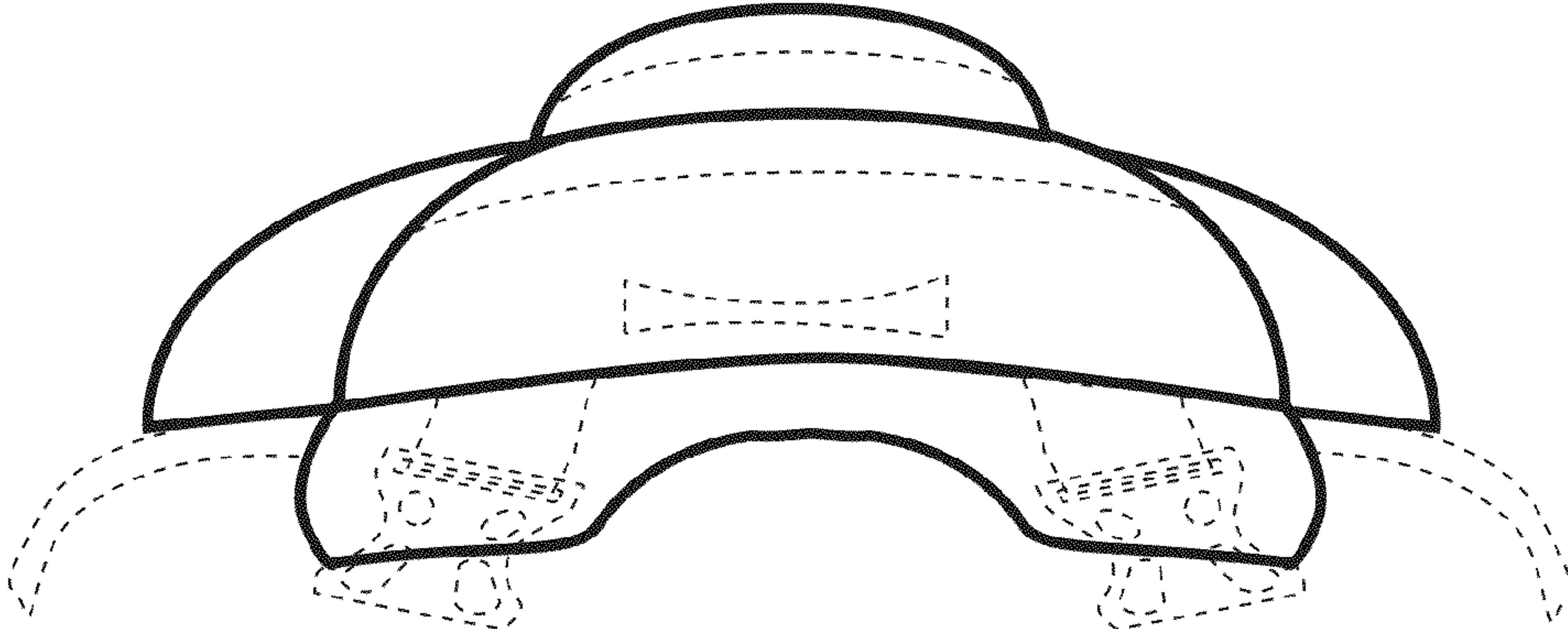

FIGURE 12.



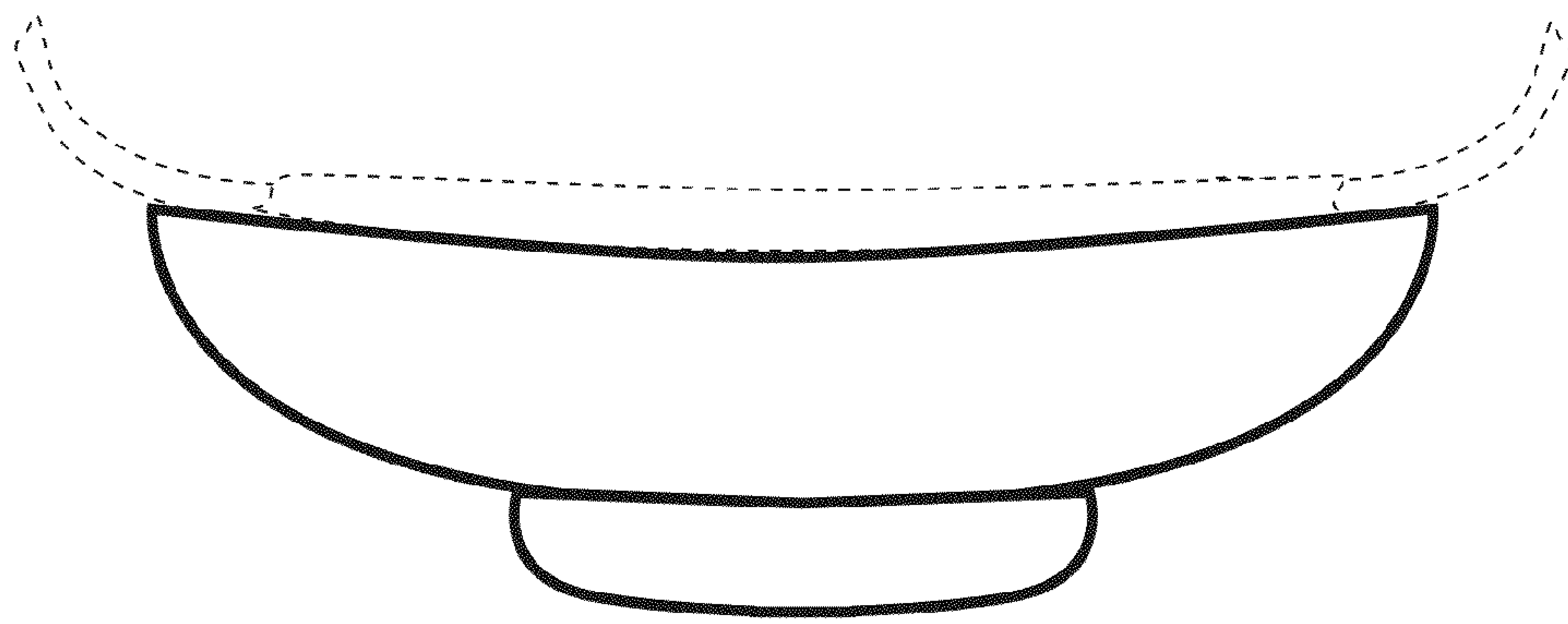

FIGURE 13.