



US00D737517S

(12) **United States Design Patent**  
**Yiu**

(10) **Patent No.:** **US D737,517 S**

(45) **Date of Patent:** **\*\* Aug. 25, 2015**

(54) **COSMETIC DEVICE**

(71) Applicant: **Soft Lines International, Ltd.**,  
Kowloon (HK)

(72) Inventor: **Wai Wah Yiu**, Kowloon (HK)

(73) Assignee: **SOFT LINES INTERNATIONAL,**  
**LTD.**, Kowloon (HK)

(\*\*) Term: **14 Years**

(21) Appl. No.: **29/488,537**

(22) Filed: **Apr. 21, 2014**

**Related U.S. Application Data**

(60) Division of application No. 29/468,166, filed on Sep. 26, 2013, now Pat. No. Des. 706,986, which is a continuation of application No. 29/450,476, filed on Mar. 18, 2013, now Pat. No. Des. 692,181, which is a division of application No. 29/424,848, filed on Jun. 15, 2012, now Pat. No. Des. 681,277.

(51) **LOC (10) Cl.** ..... **28-03**

(52) **U.S. Cl.**  
USPC ..... **D28/58**; D28/59; D28/49; D28/53

(58) **Field of Classification Search**  
USPC ..... 132/73, 73.5–73.6, 75.3, 75.6, 75.8,  
132/76.4–76.5; D28/56–62, 49–54;  
30/43.92, 34.1, 26; D24/146, 133;  
606/131–134; 607/88  
CPC ..... A61B 17/54; A45D 44/00; A45D 29/14;  
A45D 29/05; A45D 29/00

See application file for complete search history.

(56) **References Cited**

U.S. PATENT DOCUMENTS

1,482,837 A 2/1924 Buck  
2,867,214 A 1/1959 Wilson  
2,936,768 A 5/1960 Chamberlain  
3,581,393 A 6/1971 Yager

(Continued)

OTHER PUBLICATIONS

U.S. Appl. No. 29/435,131, filed Oct. 19, 2012, Soft Lines International, Inc.

(Continued)

*Primary Examiner* — Jennifer Rivard

(74) *Attorney, Agent, or Firm* — Foley & Lardner LLP

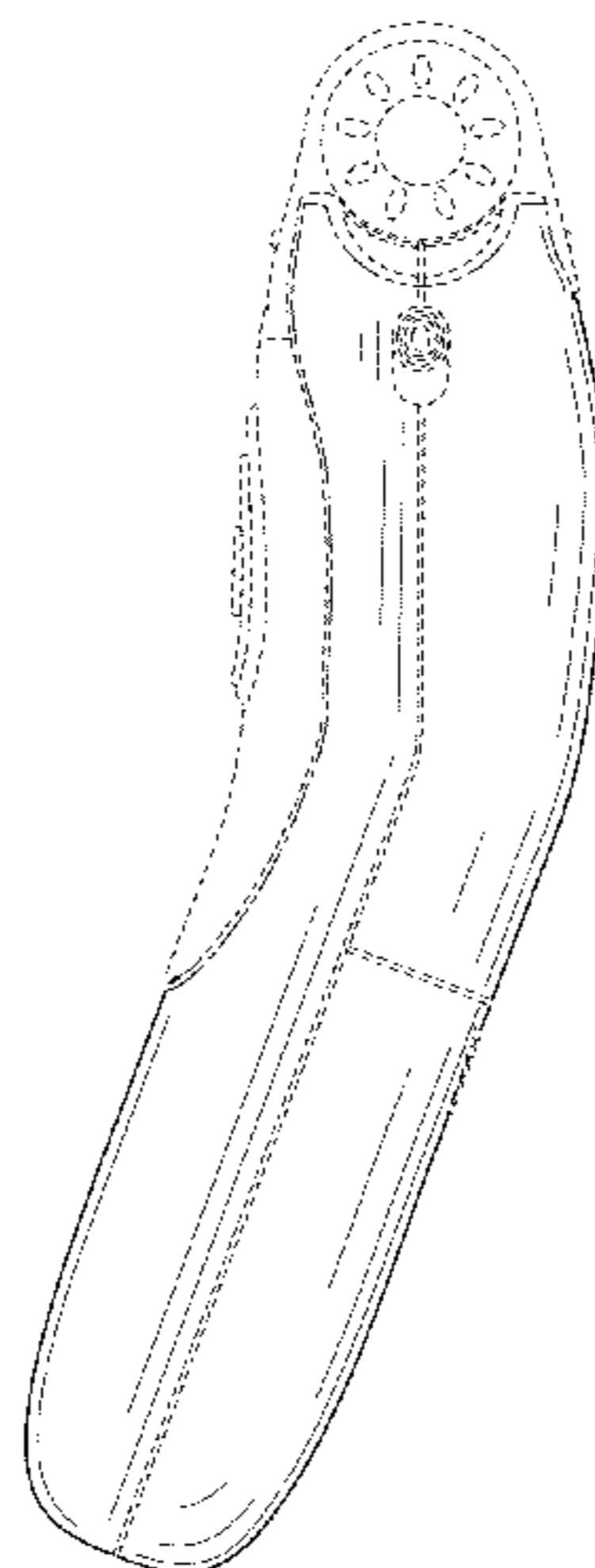
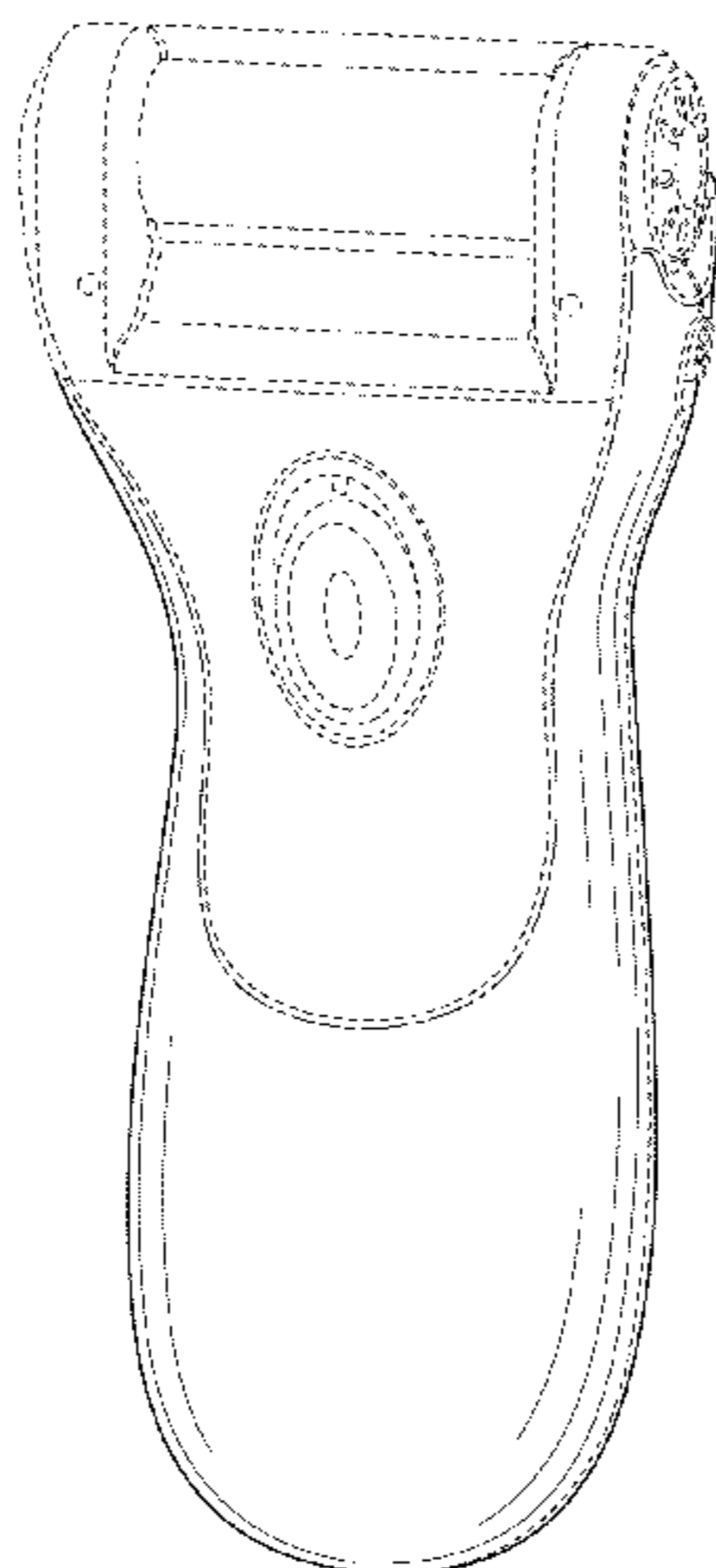
(57) **CLAIM**

I claim the ornamental design for a cosmetic device, as shown and described.

**DESCRIPTION**

FIG. 1 is a top, right, front perspective view of an embodiment of the claimed design;  
FIG. 2 is a top, right, rear perspective view of the claimed design of FIG. 1;  
FIG. 3 is a front elevation view of the claimed design of FIG. 1;  
FIG. 4 is a rear elevation view of the claimed design of FIG. 1;  
FIG. 5 is a right elevation view of the claimed design of FIG. 1;  
FIG. 6 is a left elevation view of the claimed design of FIG. 1;  
FIG. 7 is a top plan view of the claimed design of FIG. 1; and  
FIG. 8 is a bottom plan view of the claimed design of FIG. 1.  
The ornamental design which is claimed is shown in solid lines in the drawings. Broken lines formed of unequal length dashes (i.e., dash-dot) represent bounds of claimed portions of the design. Broken lines formed by equal length dashes (i.e., dash-dash) illustrate unclaimed portions of the design. The broken lines in the drawings are for illustrative purposes only and form no part of the claimed design.

**1 Claim, 7 Drawing Sheets**



(56)

References Cited

U.S. PATENT DOCUMENTS

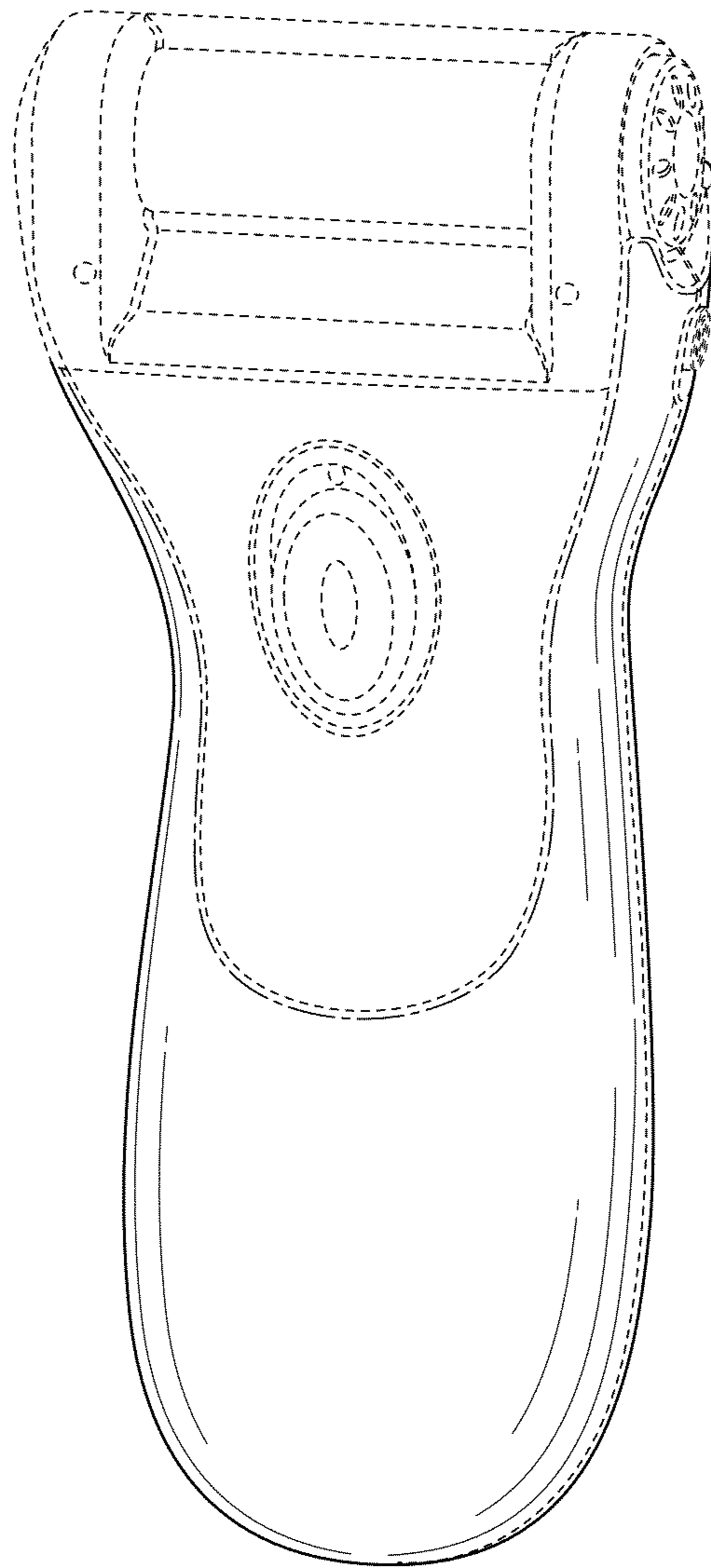
4,935,184 A 6/1990 Sorensen  
 5,033,485 A 7/1991 Hauerwas et al.  
 5,281,233 A 1/1994 Dolev  
 5,377,699 A 1/1995 Varnum  
 5,383,273 A 1/1995 Muller et al.  
 D386,822 S 11/1997 Van Scoyoc et al.  
 D409,335 S 5/1999 Slater  
 5,976,157 A 11/1999 Yiu  
 D421,155 S 2/2000 Grange  
 D421,320 S 2/2000 Coffin et al.  
 6,123,713 A 9/2000 Yiu  
 6,159,222 A 12/2000 Yiu  
 D453,396 S 2/2002 Grange  
 6,391,034 B1 5/2002 Adamson et al.  
 6,436,106 B2 8/2002 Yiu  
 6,471,712 B2\* 10/2002 Burres ..... 606/131  
 6,523,546 B2 2/2003 Jo et al.  
 6,551,262 B1 4/2003 Lechtman  
 6,824,461 B1 11/2004 Dolev  
 6,824,546 B1 11/2004 Yiu  
 D499,842 S 12/2004 Yiu  
 D509,626 S 9/2005 Yiu  
 D512,531 S 12/2005 Khubani et al.  
 D535,057 S 1/2007 Hara  
 D556,380 S 11/2007 Long  
 D581,596 S 11/2008 Sarway  
 D598,165 S 8/2009 Platek  
 7,581,545 B1 9/2009 Moldawski et al.  
 7,597,696 B2 10/2009 Poran  
 D611,198 S 3/2010 Platek

D626,692 S 11/2010 Leventhal et al.  
 D626,693 S 11/2010 Harbeke  
 D628,744 S 12/2010 Goetschi  
 D638,166 S 5/2011 Martinez De San Vicente  
 D645,204 S 9/2011 Platek  
 8,066,013 B2\* 11/2011 Tes et al. .... 132/73.6  
 8,226,662 B2\* 7/2012 Song ..... 606/131  
 D676,200 S 2/2013 Yiu  
 D678,614 S 3/2013 Yiu  
 D681,277 S 4/2013 Yiu  
 D686,370 S 7/2013 Yiu  
 D692,181 S 10/2013 Yiu  
 8,545,516 B1\* 10/2013 Winnett et al. .... 606/131  
 8,551,117 B2 10/2013 Yiu  
 D701,648 S 3/2014 Yiu  
 8,661,650 B2\* 3/2014 Da Silva et al. .... 29/592.1  
 D706,487 S 6/2014 Yiu  
 D706,986 S 6/2014 Yiu  
 2005/0187563 A1 8/2005 Yiu  
 2006/0260629 A1 11/2006 Chern  
 2008/0187563 A1 8/2008 Levy  
 2009/0182349 A1 7/2009 Poran  
 2009/0209977 A1 8/2009 Rogatschnig  
 2009/0301507 A1 12/2009 Tes et al.  
 2012/0226289 A1\* 9/2012 Yiu ..... 606/131

OTHER PUBLICATIONS

U.S. Appl. No. 29/456,966, filed Jun. 5, 2013, Soft Lines International, Ltd.  
 U.S. Appl. No. 29/459,570, filed Jul. 1, 2013, Soft Lines International, Ltd.

\* cited by examiner



**FIG. 1**

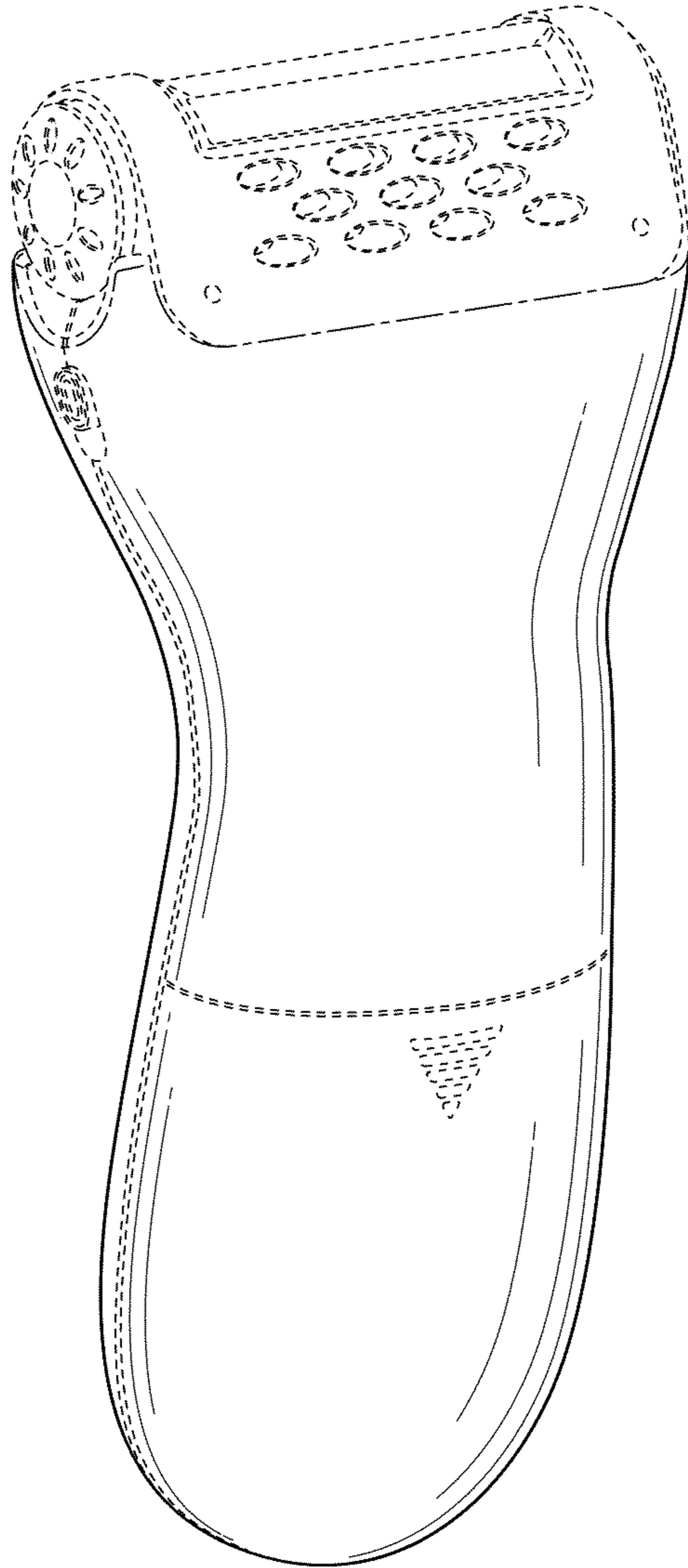
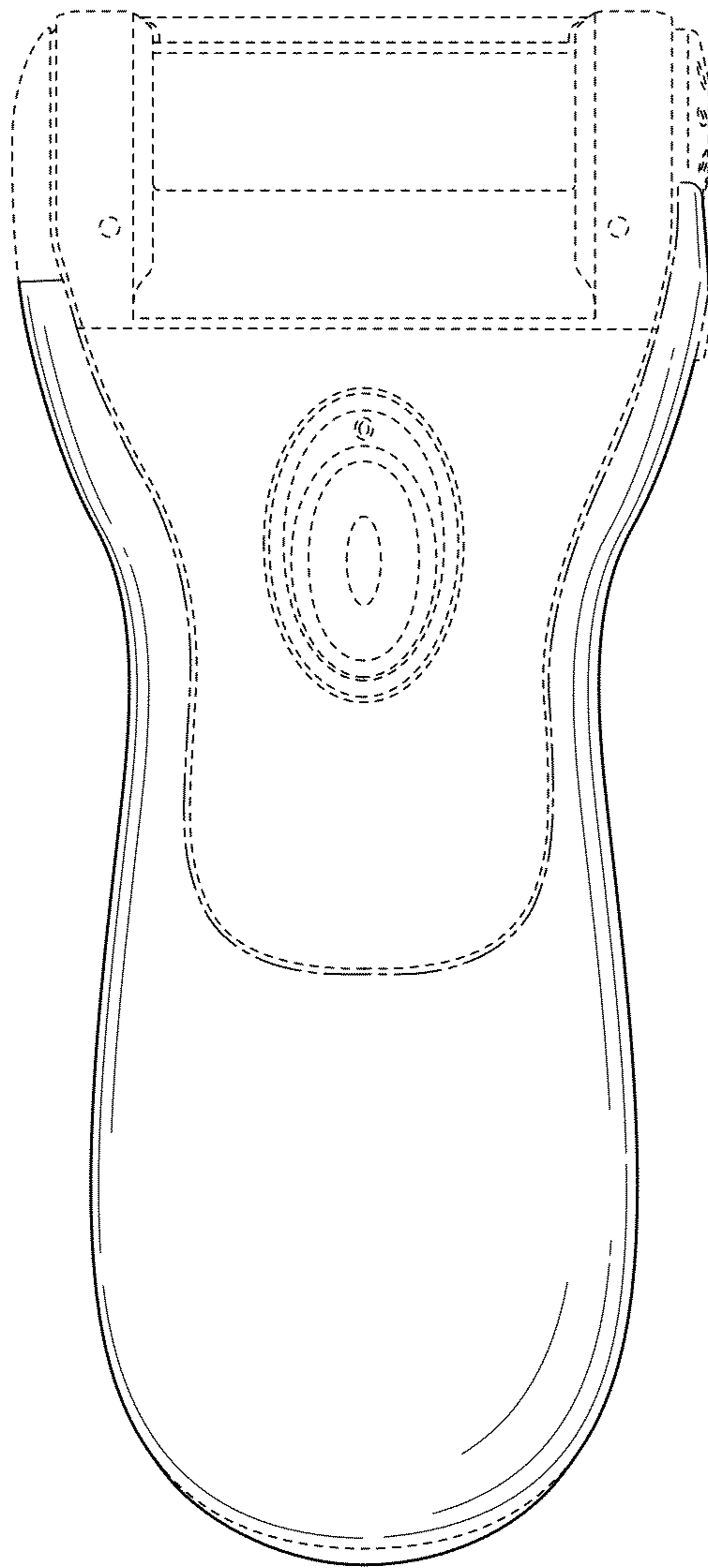
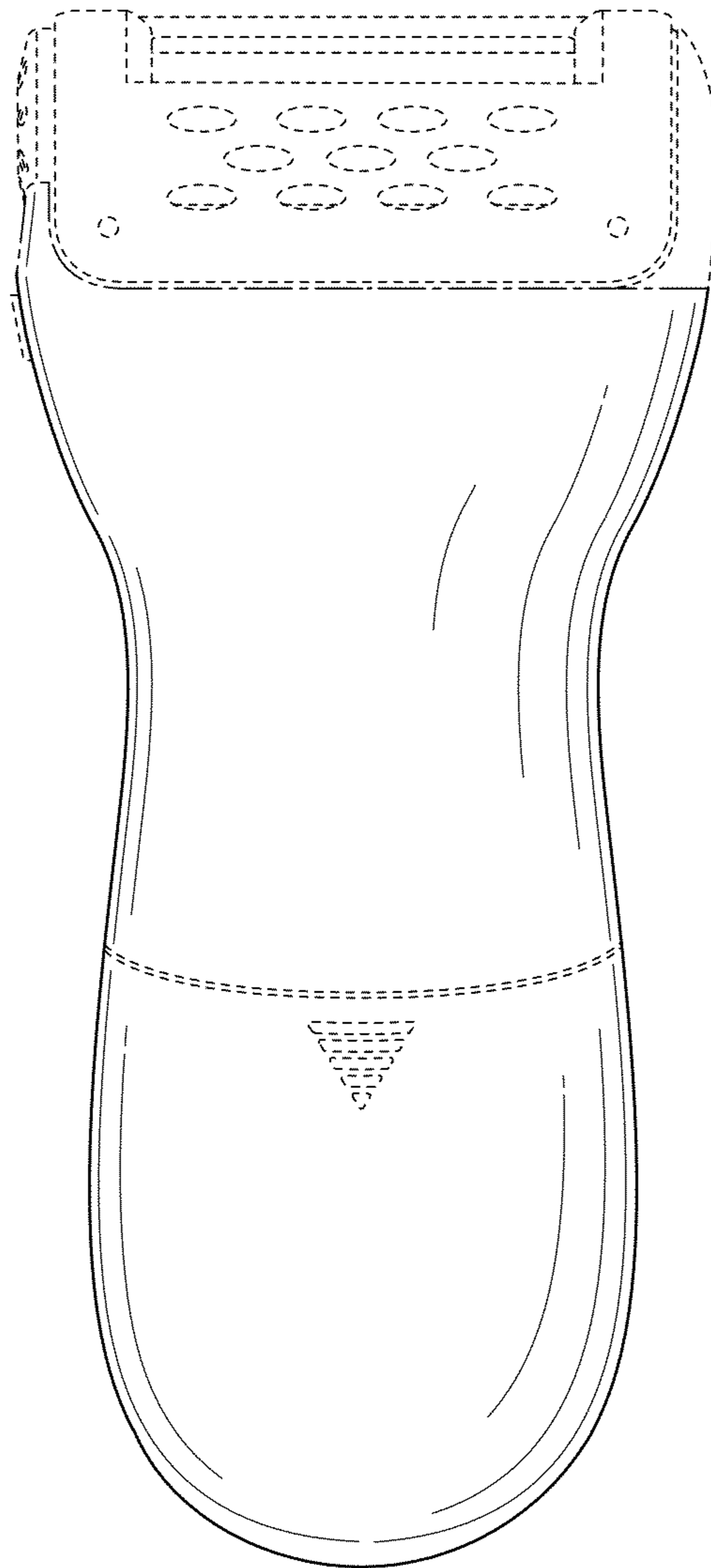


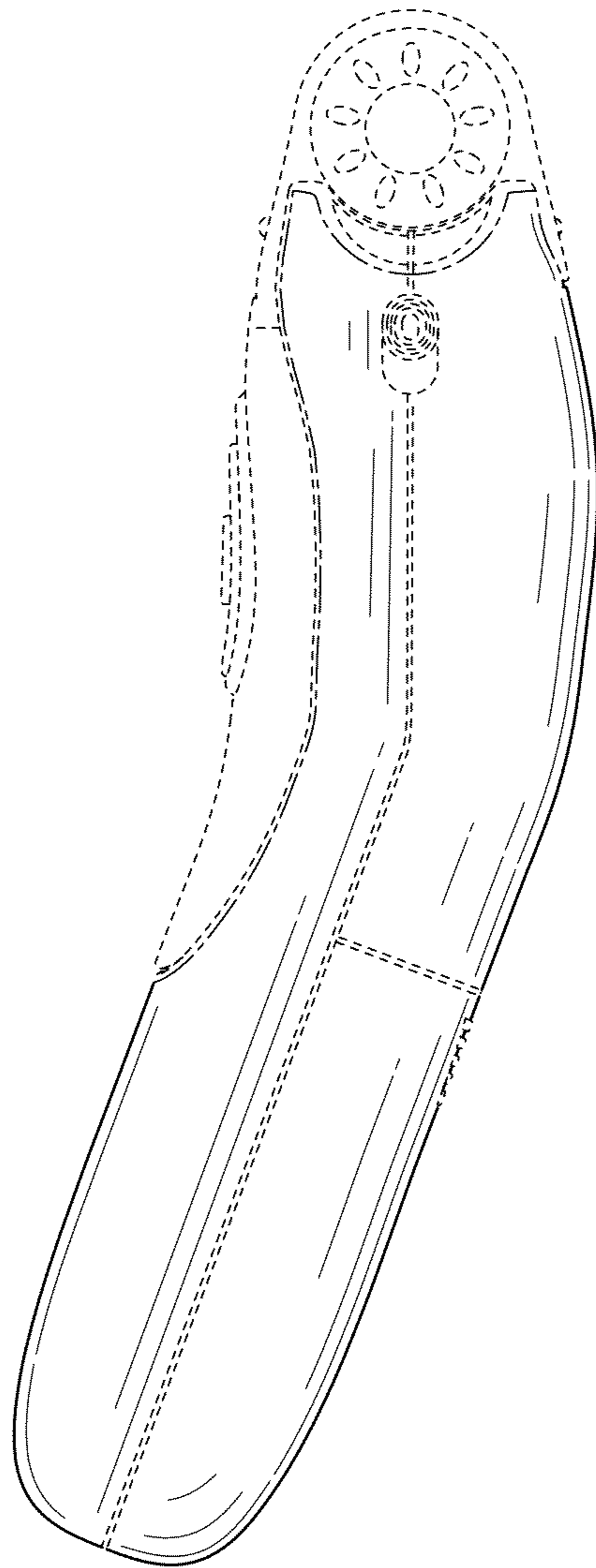
FIG. 2



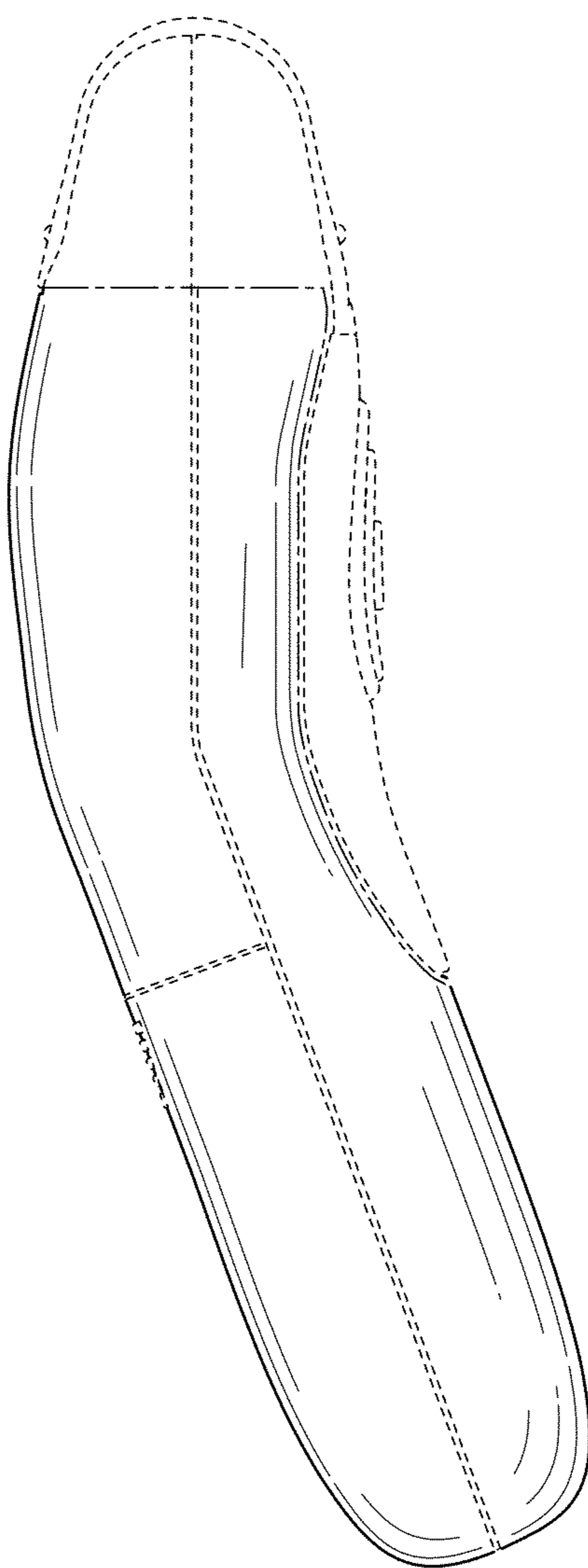
**FIG. 3**



**FIG. 4**

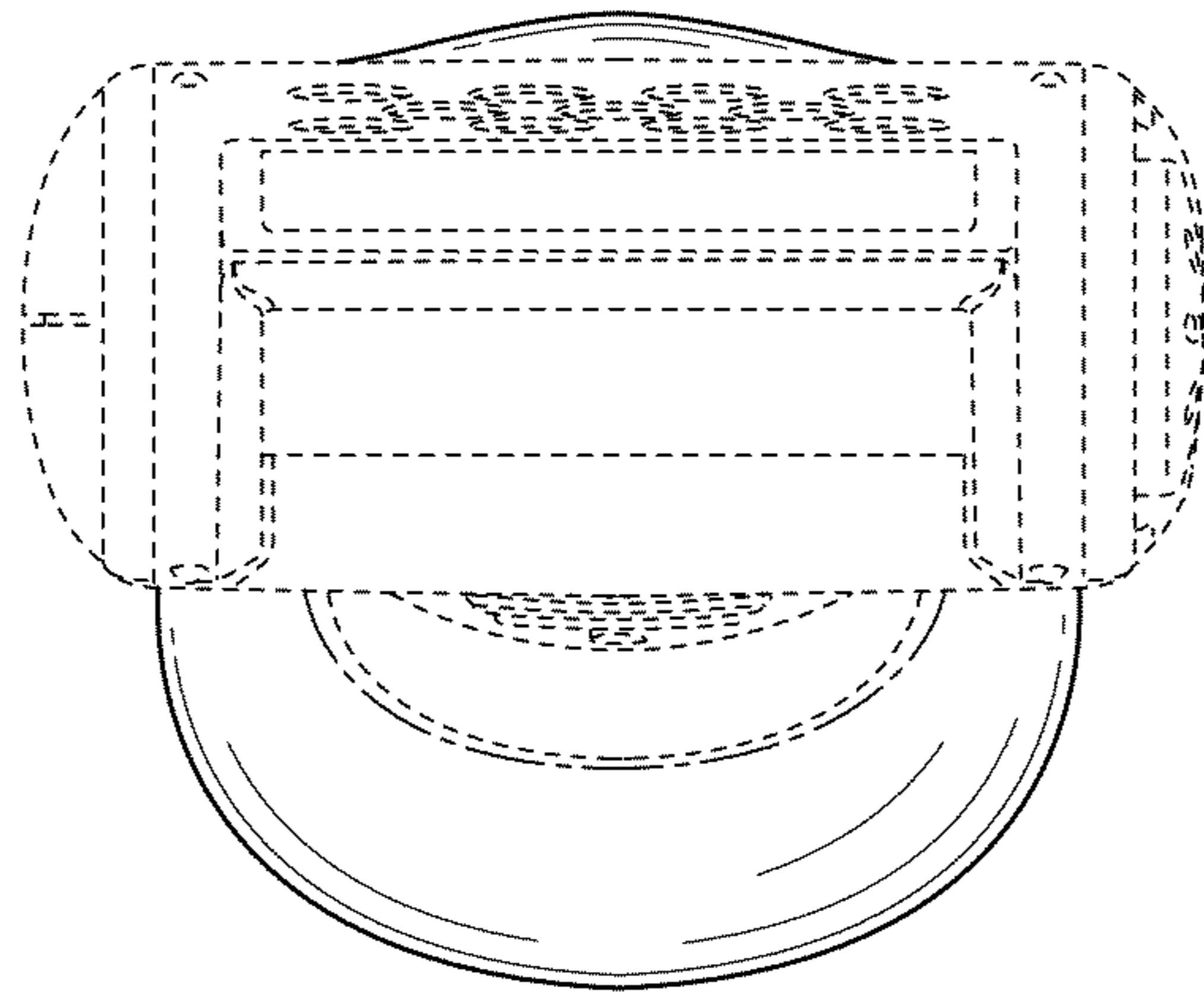


**FIG. 5**

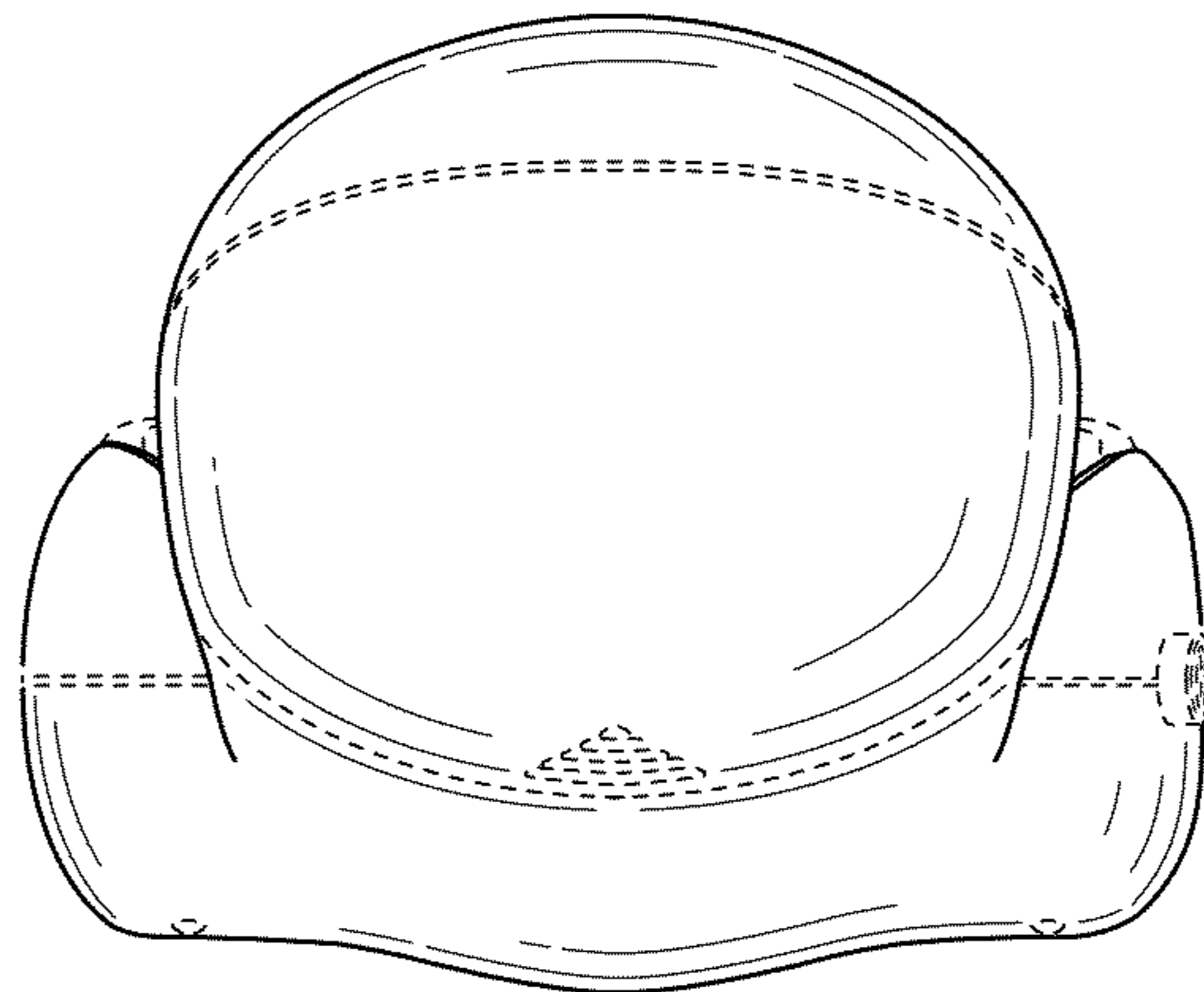


**FIG. 6**





**FIG. 7**



**FIG. 8**