



US00D737505S

(12) **United States Design Patent**  
**Liu**

(10) **Patent No.:** **US D737,505 S**  
(45) **Date of Patent:** **\*\* Aug. 25, 2015**

(54) **ELECTRONIC CIGARETTE CASE**

- (71) Applicant: **Qiuming Liu**, Shenzhen (CN)
- (72) Inventor: **Qiuming Liu**, Shenzhen (CN)
- (73) Assignee: **KIMREE HI-TECH INC.**, Road Town, Tortola (VG)
- (\*\*) Term: **14 Years**
- (21) Appl. No.: **29/461,620**
- (22) Filed: **Jul. 25, 2013**
- (30) **Foreign Application Priority Data**

Jul. 19, 2013 (CN) ..... 2013 3 0340088

(51) **LOC (10) Cl.** ..... **27-06**

(52) **U.S. Cl.**  
USPC ..... **D27/189**

(58) **Field of Classification Search**  
 USPC ..... D27/129, 141, 144, 152, 153, 157, 160,  
 D27/172, 174, 175, 183, 186, 187, 189–191,  
 D27/193, 194; D9/420, 423, 504, 529, 545,  
 D9/686, 688; D13/108; 206/242, 249, 250,  
 206/256, 259, 261, 264, 265, 267, 268;  
 D3/273, 294; 131/270–273, 329–330,  
 131/347  
 CPC ..... A24F 13/14; A24F 9/16; A24F 15/00;  
 A24F 15/12; A24F 15/14; A24F 15/18;  
 A24F 15/005; A24F 15/20; A24F 23/00;  
 A24F 23/04

See application file for complete search history.

(56) **References Cited**

**U.S. PATENT DOCUMENTS**

D296,938 S \* 7/1988 Ameringen ..... D9/423  
 5,097,948 A \* 3/1992 Campbell ..... 206/268

(Continued)

*Primary Examiner* — Susan Bennett Hattan

*Assistant Examiner* — Janice Hallmark

(74) *Attorney, Agent, or Firm* — Locke Lord LLP; Tim Tingkang Xia, Esq.

(57) **CLAIM**

The ornamental design for an electronic cigarette case, as shown and described.

**DESCRIPTION**

FIG. 1 is a front elevational view of a first embodiment of an electronic cigarette case;  
 FIG. 2 is a rear elevational view of the first embodiment of the electronic cigarette case;  
 FIG. 3 is a top plan view of the first embodiment of the electronic cigarette case;  
 FIG. 4 is a bottom plan view of the first embodiment of the electronic cigarette case;  
 FIG. 5 is a left side elevational view of the first embodiment of the electronic cigarette case;  
 FIG. 6 is a right side elevational view of the first embodiment of the electronic cigarette case;  
 FIG. 7 is a first perspective view of the first embodiment of the electronic cigarette case;  
 FIG. 8 is a second perspective view of the first embodiment of the electronic cigarette case;  
 FIG. 9 is a third perspective view of the first embodiment of the electronic cigarette case shown in an open position.  
 FIG. 10 is a front elevational view of a second embodiment of the electronic cigarette case;  
 FIG. 11 is a rear elevational view of the second embodiment of the electronic cigarette case;  
 FIG. 12 is a top plan view of the second embodiment of the electronic cigarette case;  
 FIG. 13 is a bottom plan view of the second embodiment of the electronic cigarette case;  
 FIG. 14 is a left side elevational view of the second embodiment of the electronic cigarette case;  
 FIG. 15 is a right side elevational view of the second embodiment of the electronic cigarette case;  
 FIG. 16 is a first perspective view of the second embodiment of the electronic cigarette case;  
 FIG. 17 is a second perspective view of the second embodiment of the electronic cigarette case;  
 FIG. 18 is a third perspective view of the second embodiment of the electronic cigarette case shown in an open position;  
 and,  
 FIG. 19 is a fourth perspective view of the second embodiment of the electronic cigarette case shown in an open position.  
 The broken lines in the drawings depict environment that forms no part of the claimed design.

**1 Claim, 17 Drawing Sheets**

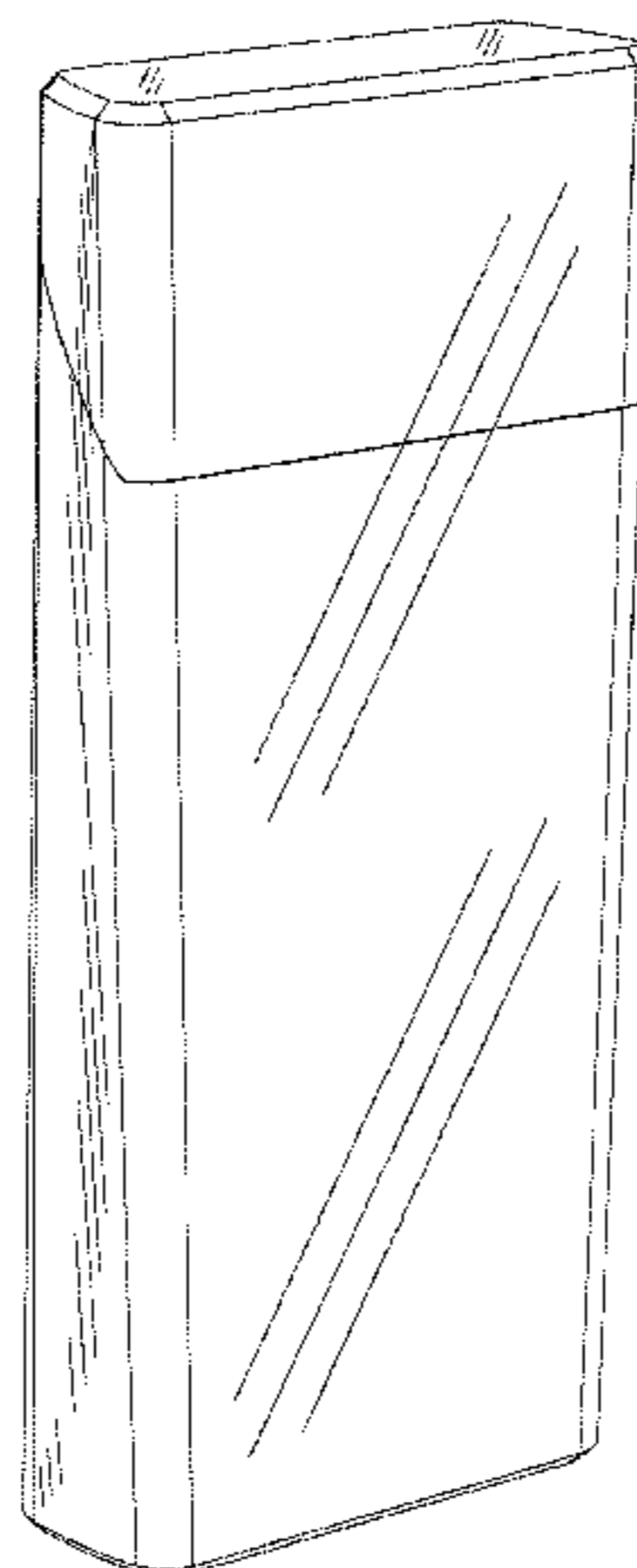
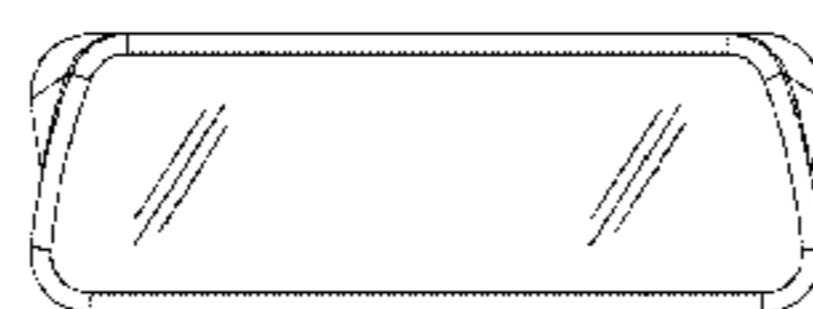

(56)

**References Cited**

U.S. PATENT DOCUMENTS

D462,479 S \* 9/2002 Draghetti ..... D27/189  
D462,807 S \* 9/2002 Draghetti ..... D27/189  
D510,777 S \* 10/2005 Engel ..... D27/189

D583,096 S \* 12/2008 Conti et al. .... D27/189  
D613,903 S \* 4/2010 Wu et al. .... D27/189  
D681,268 S \* 4/2013 Wu ..... D27/189  
D681,269 S \* 4/2013 Wu ..... D27/189  
2006/0191986 A1\* 8/2006 Focke et al. .... 229/146

\* cited by examiner

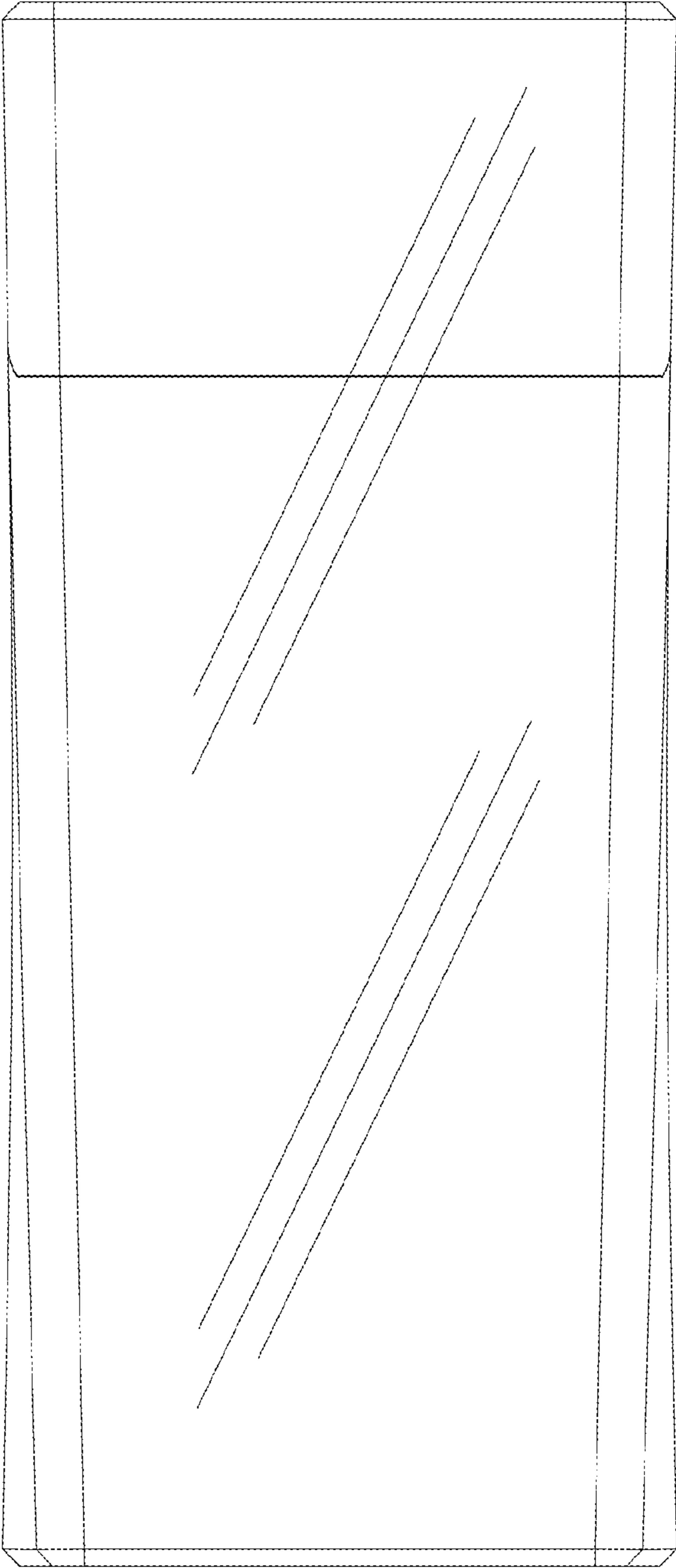

Fig. 1

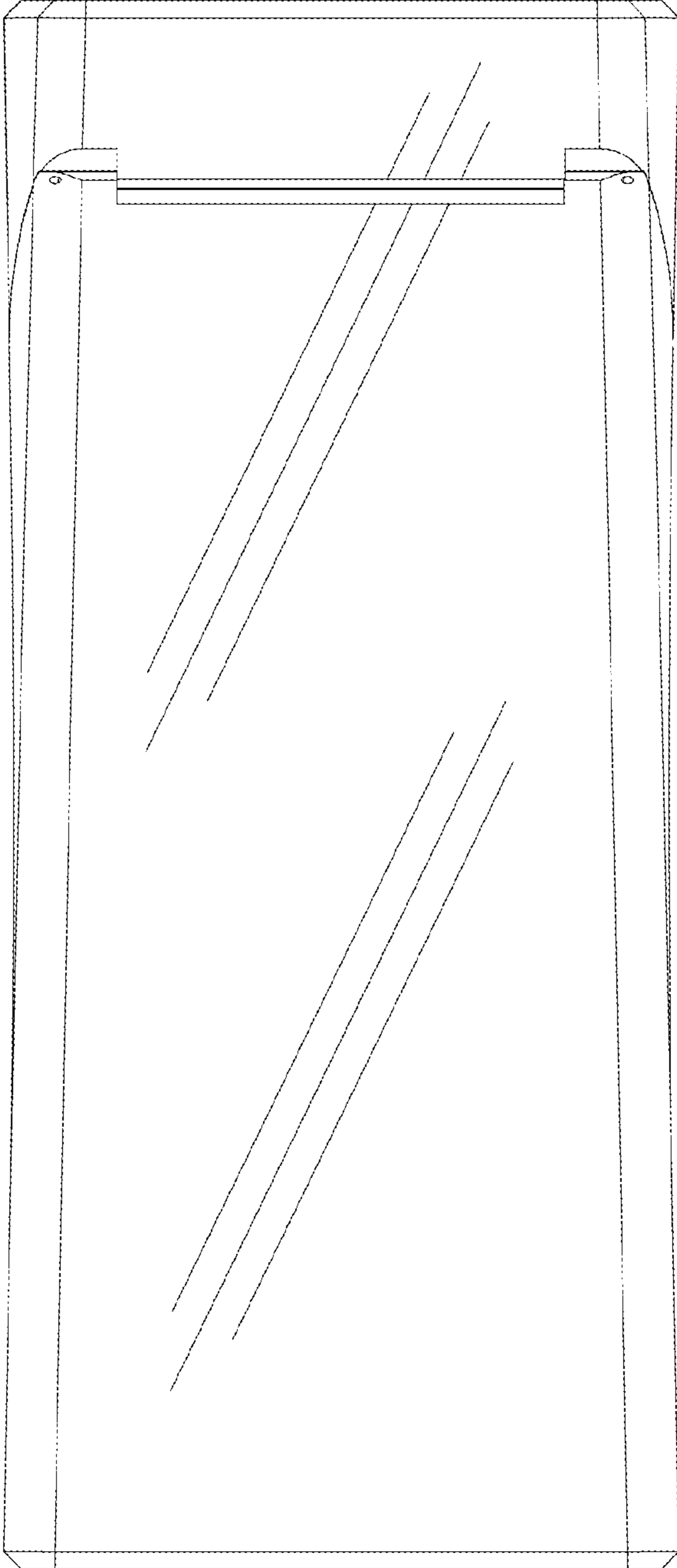

Fig. 2

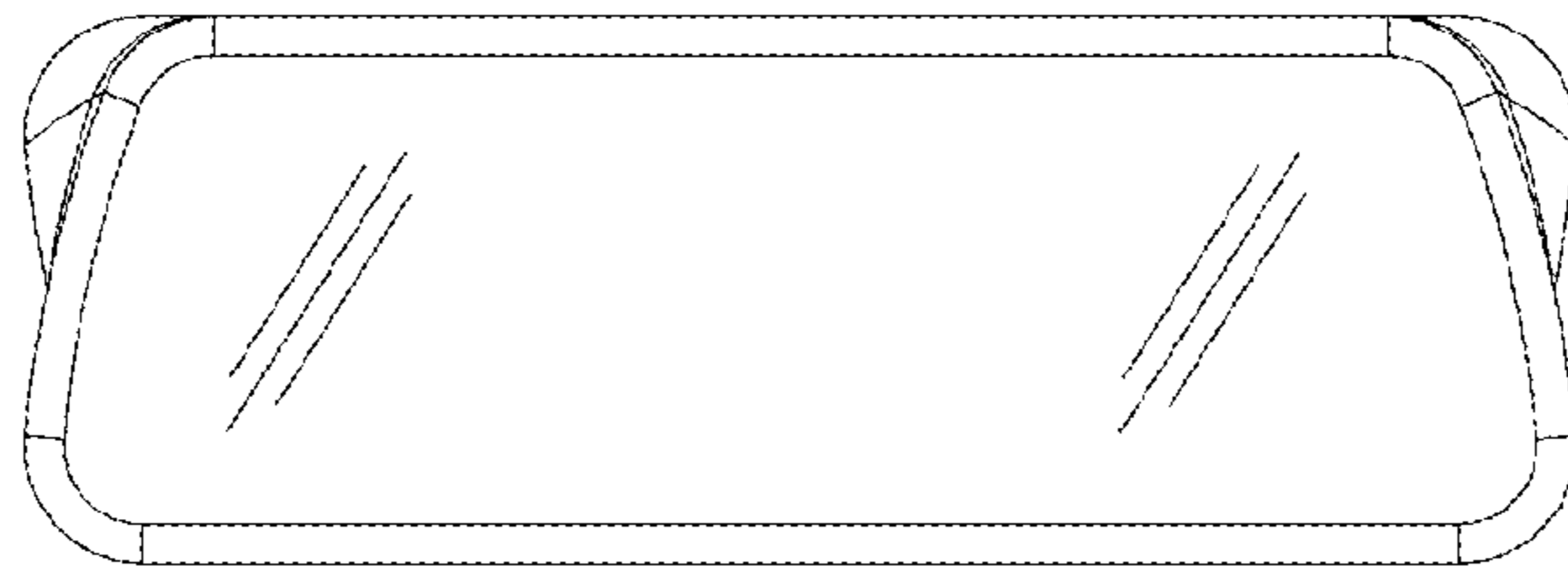

Fig. 3

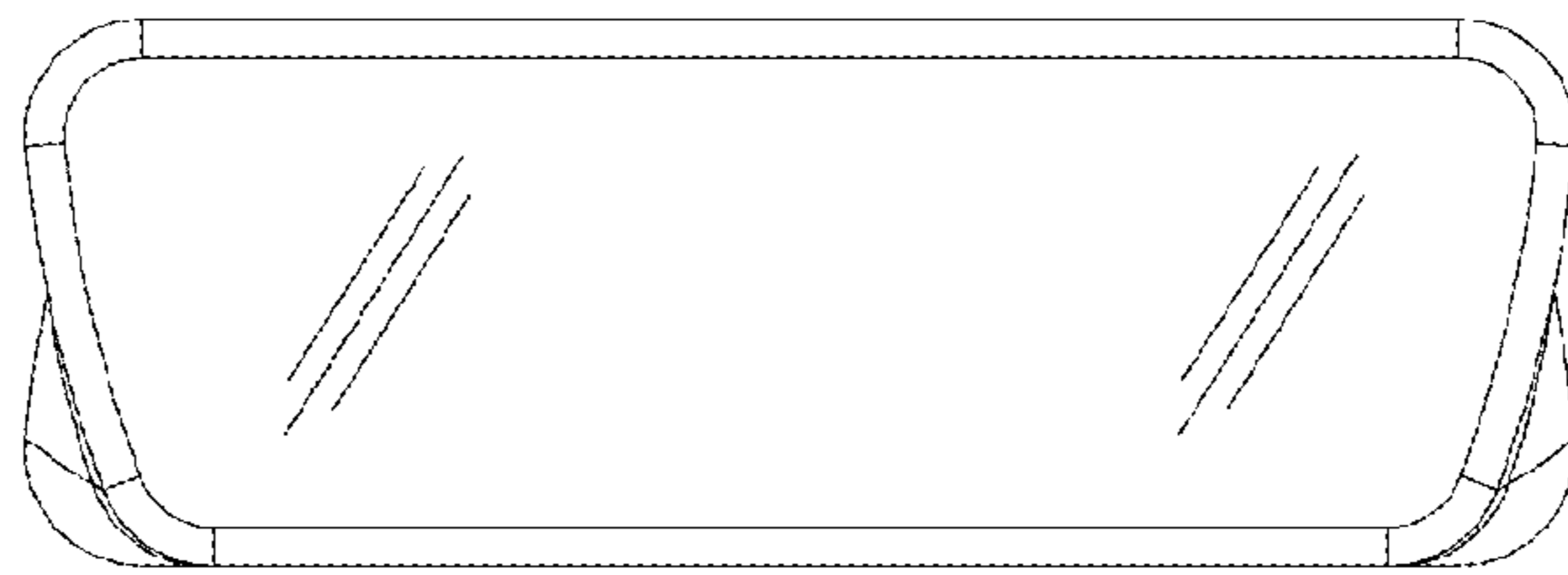

Fig. 4

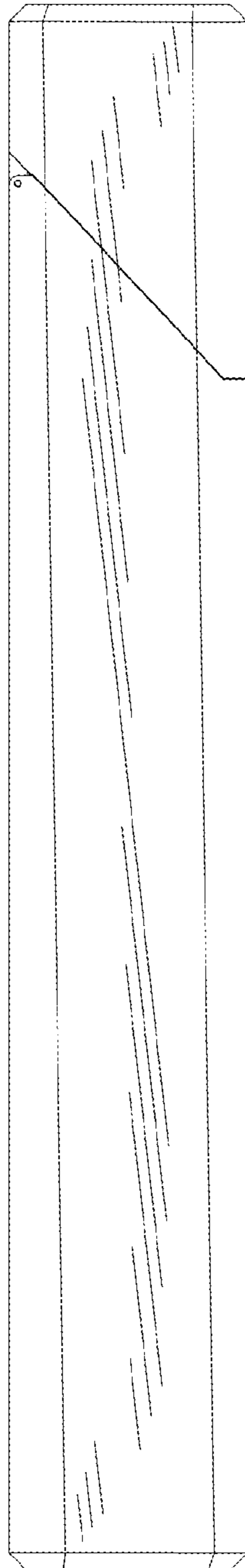

Fig. 5

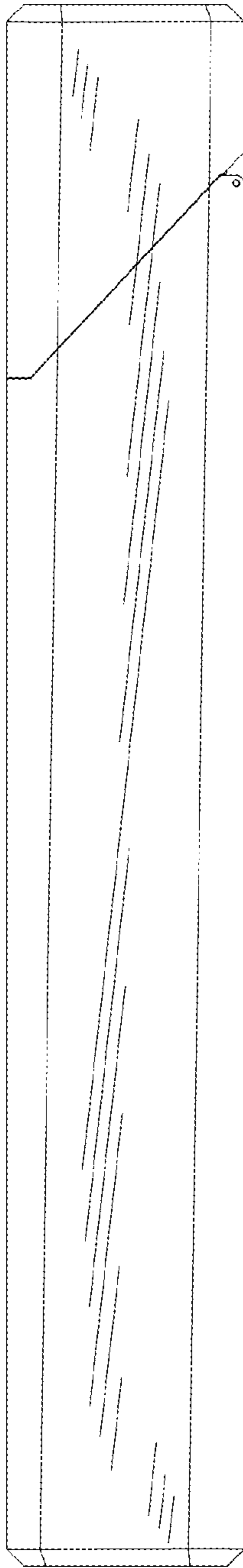

Fig. 6

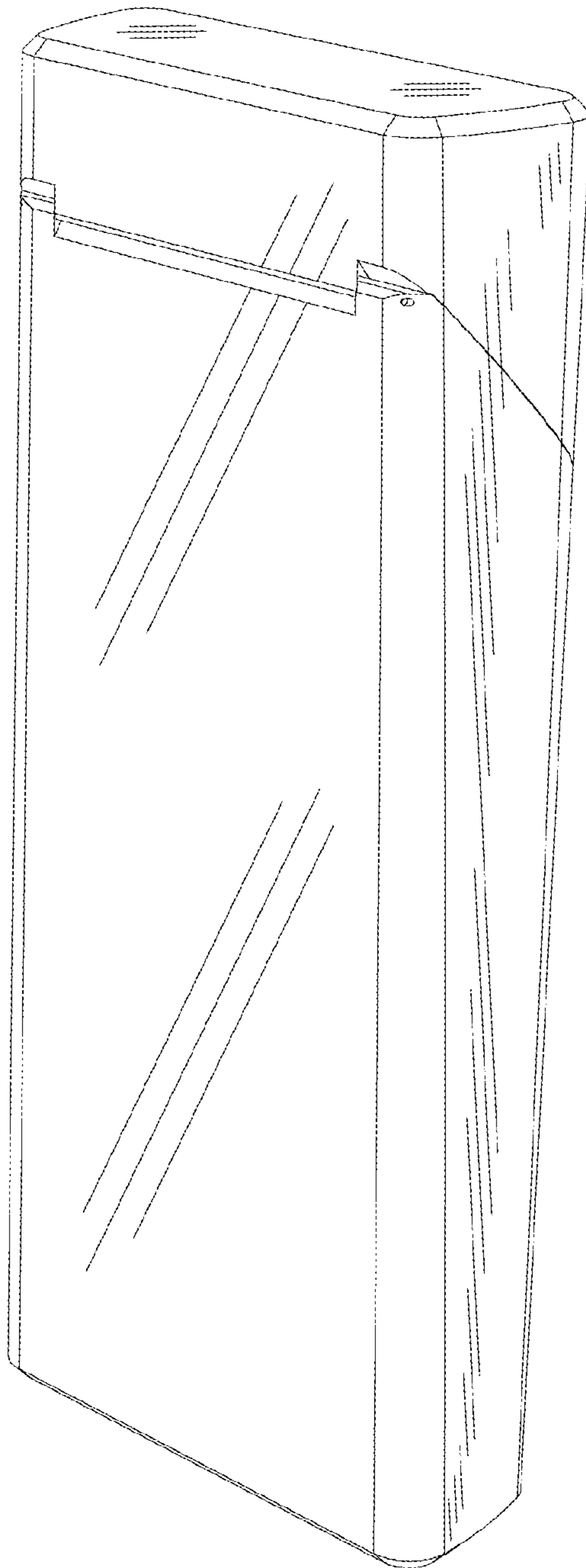

Fig. 7



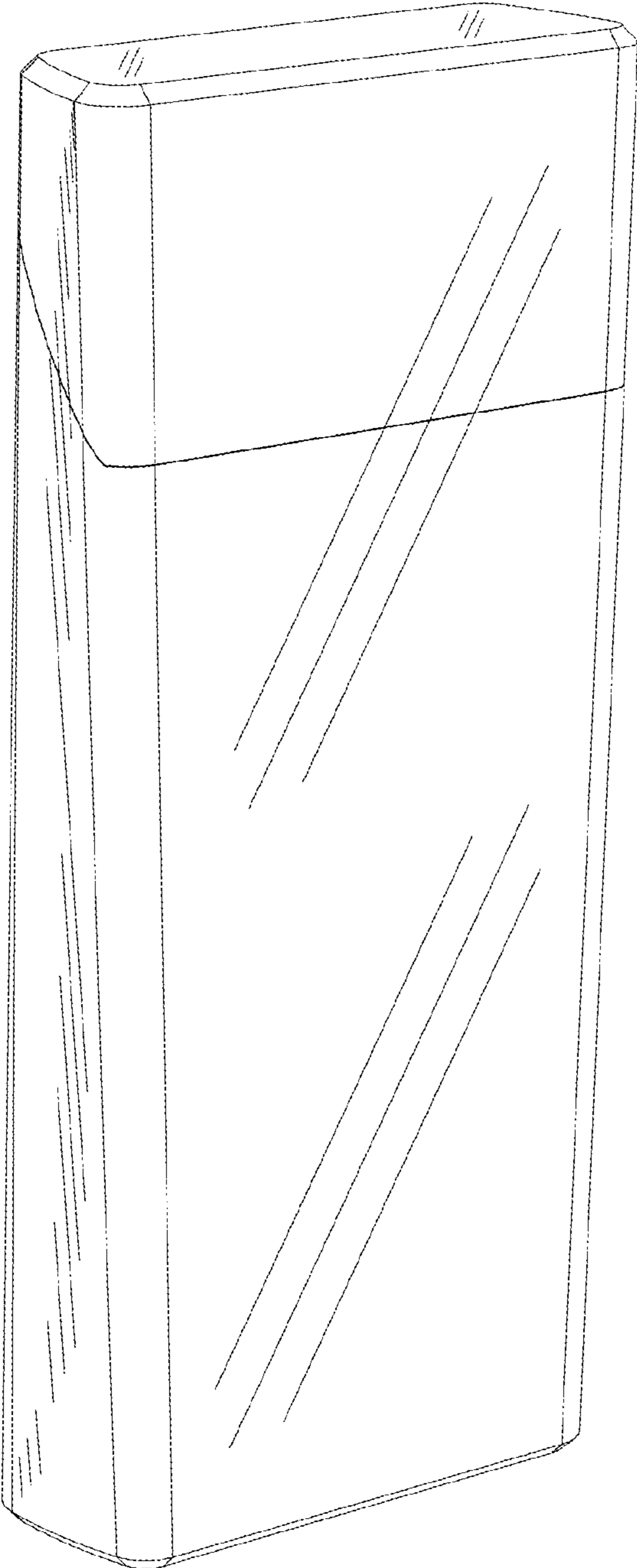

Fig. 8

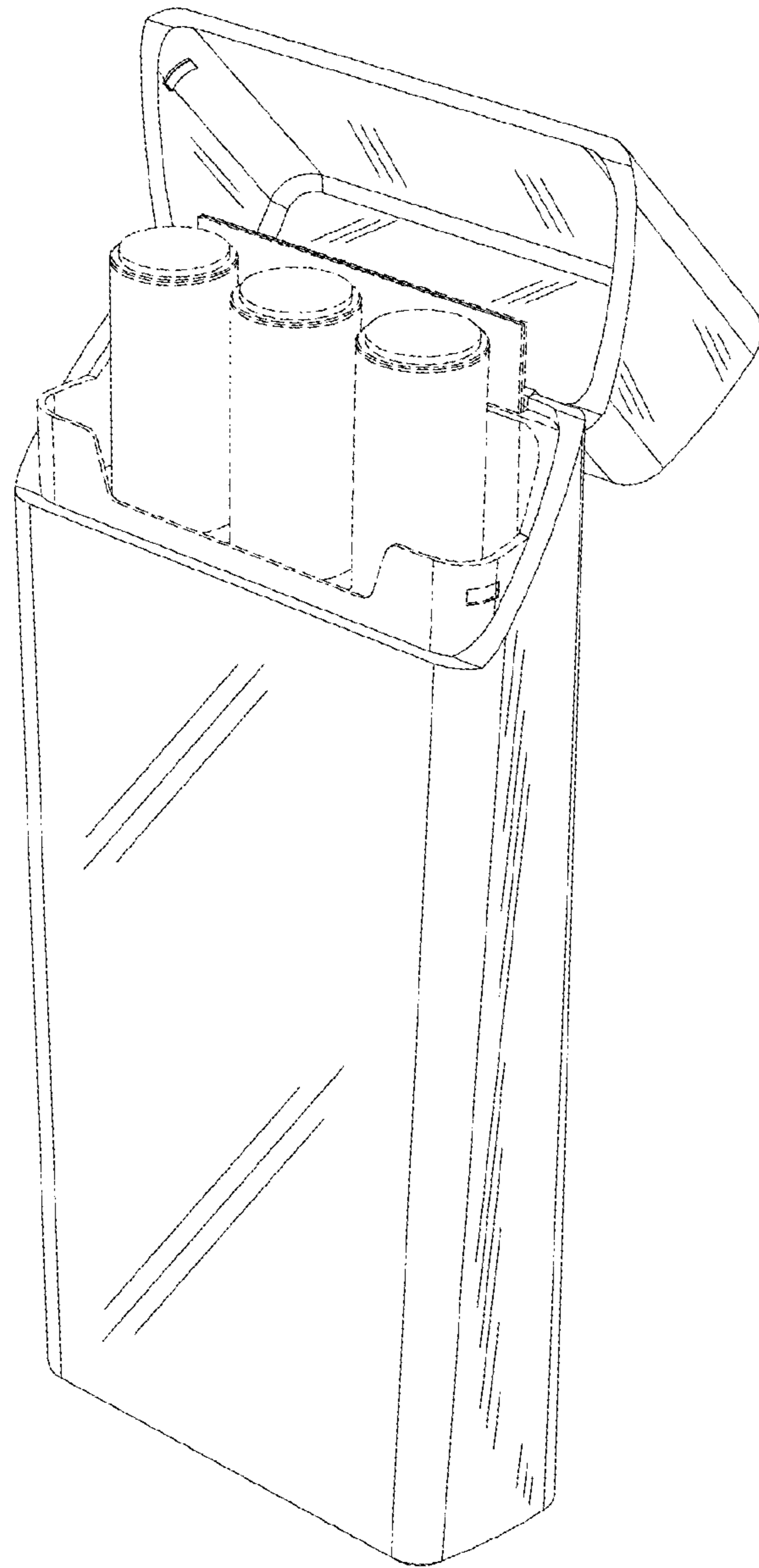

Fig. 9

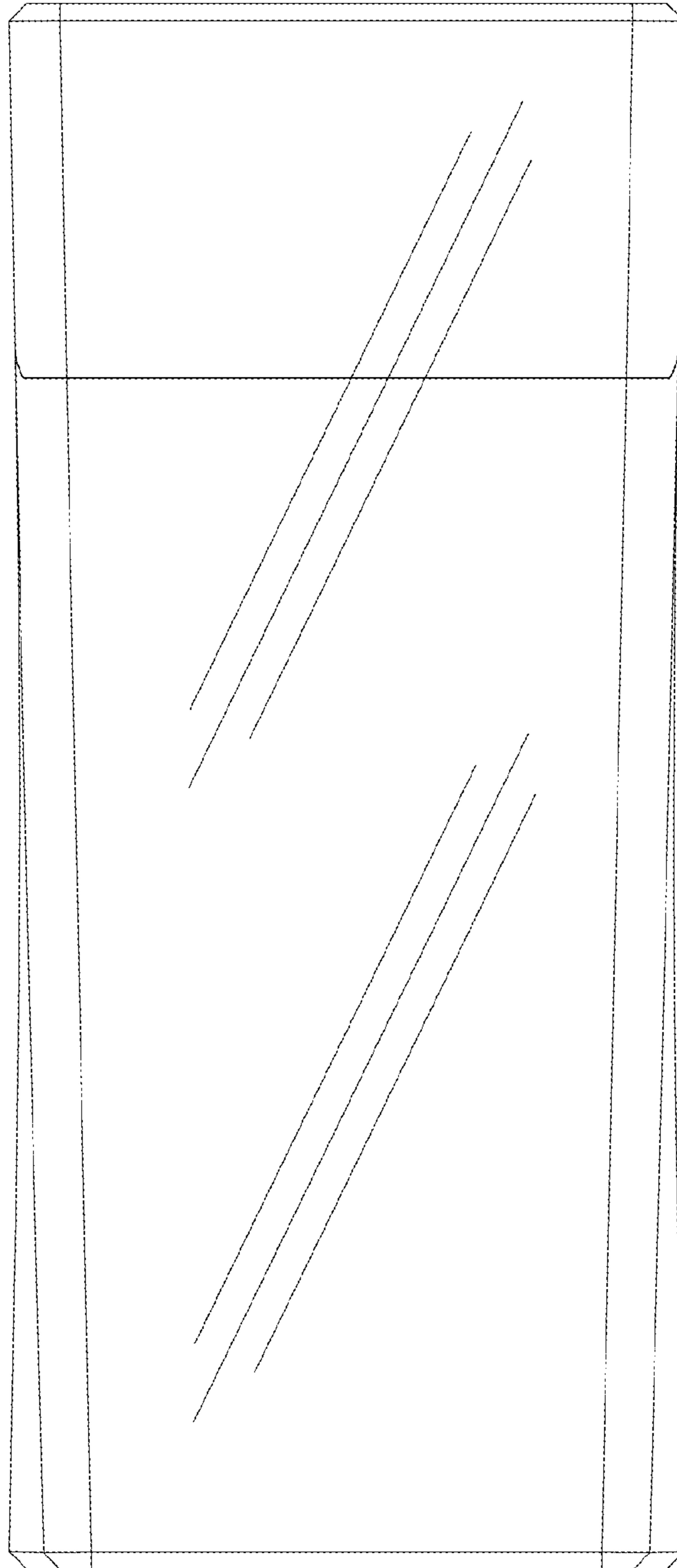

Fig. 10

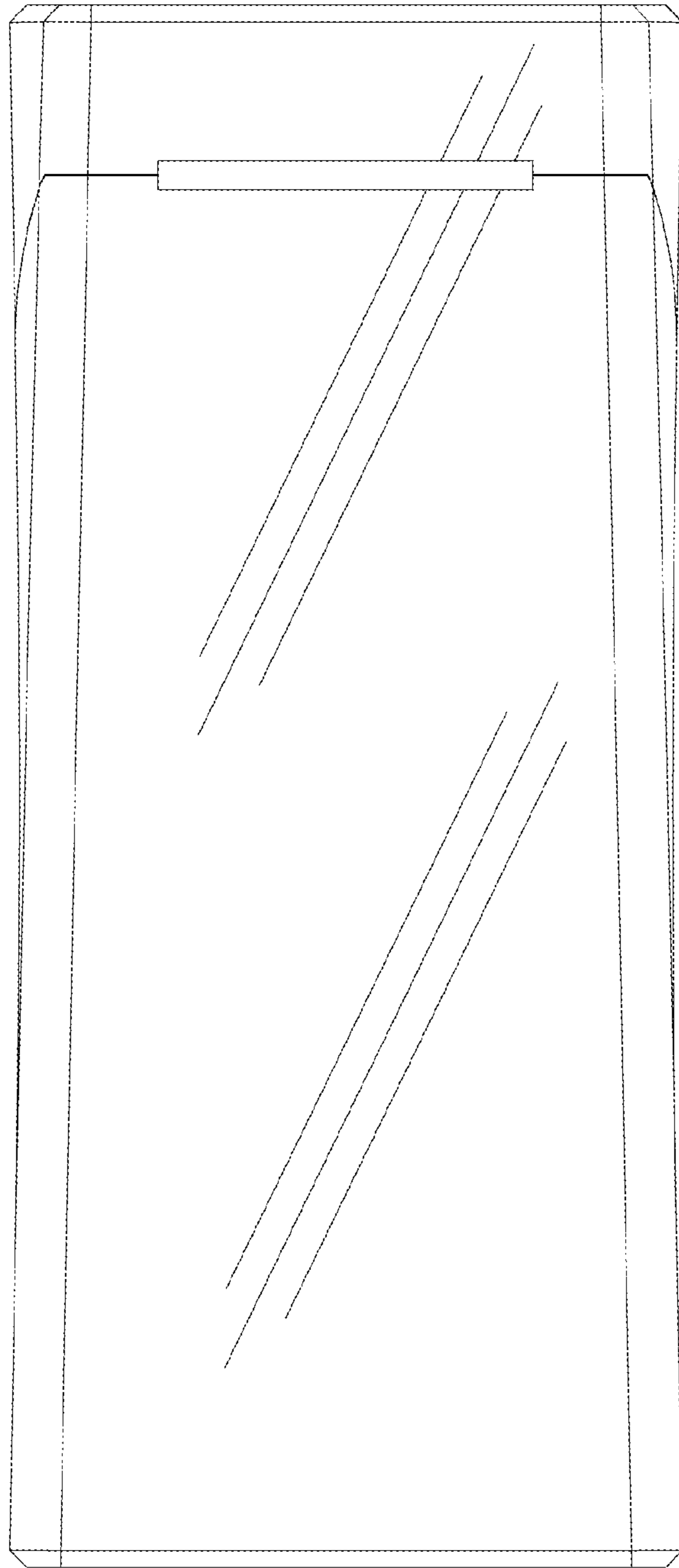

Fig. 11

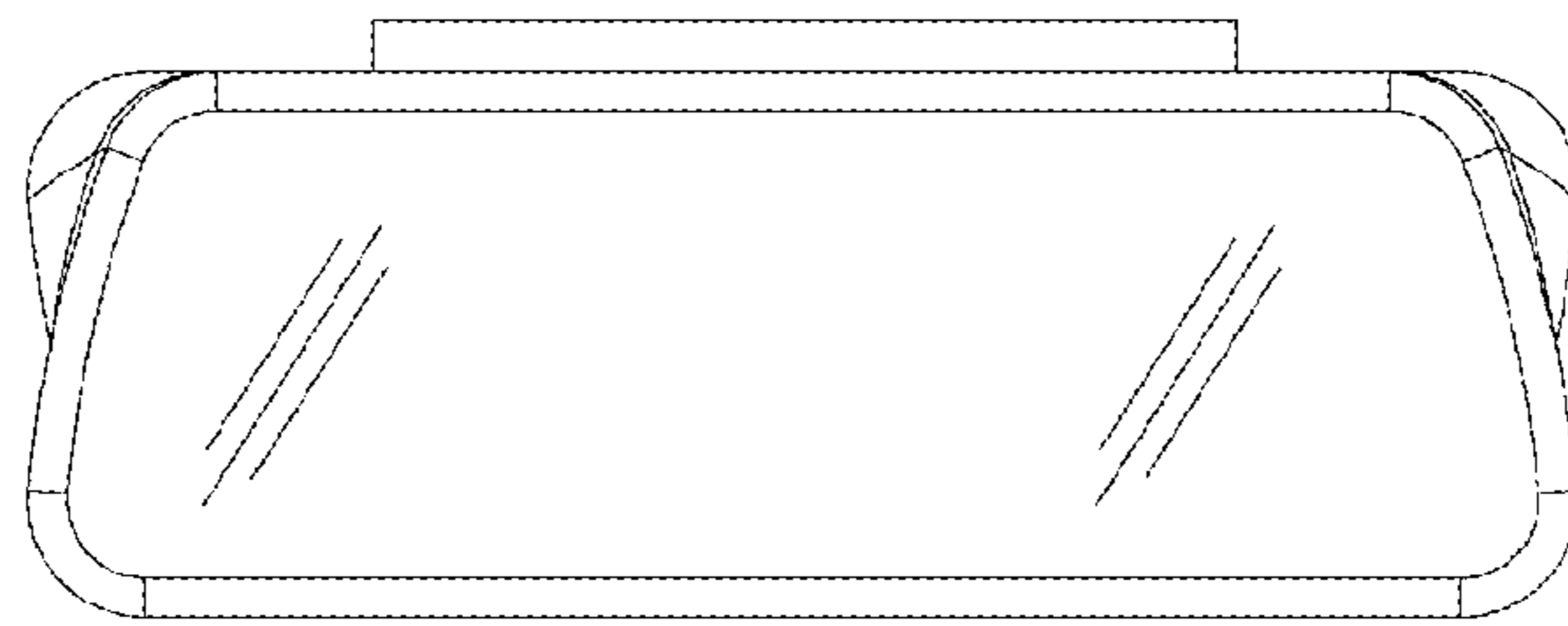

Fig. 12

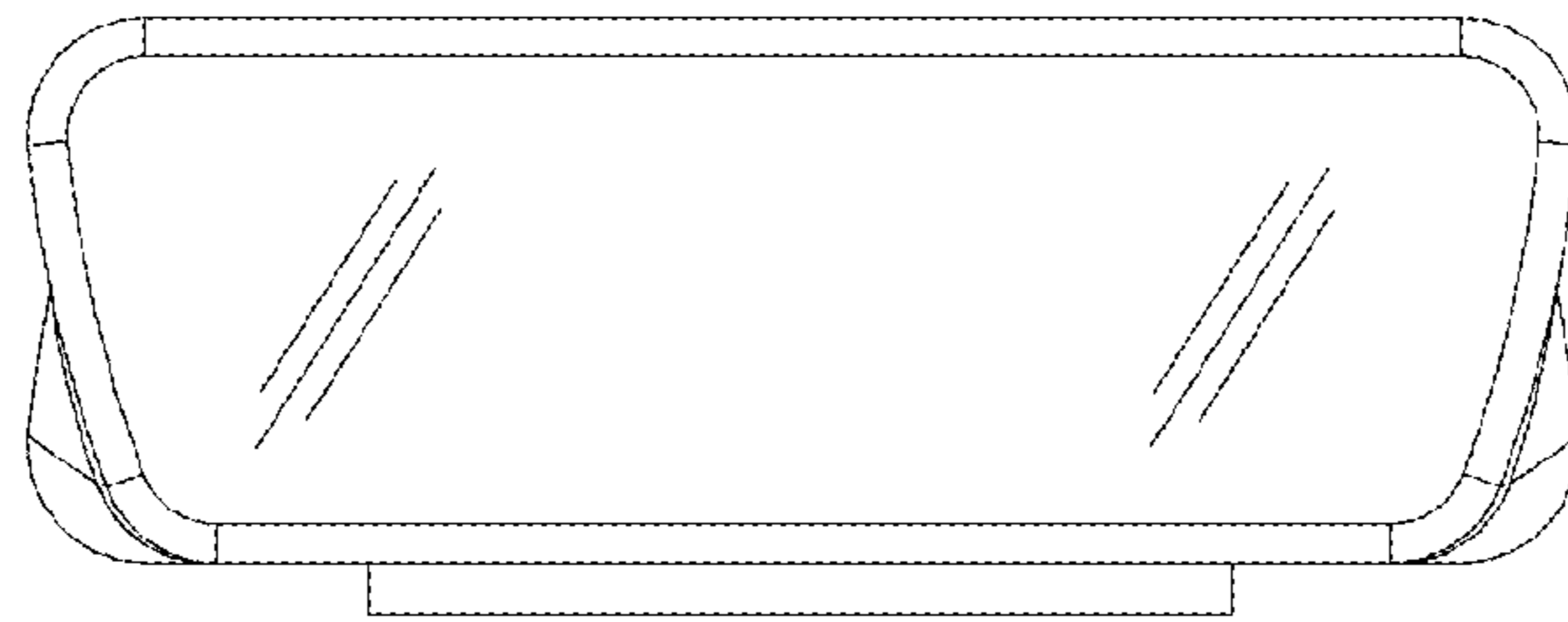

Fig. 13

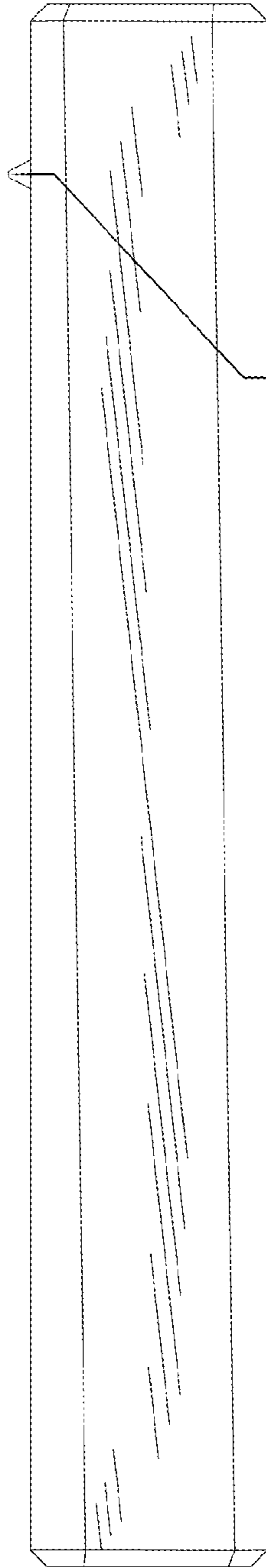

Fig. 14

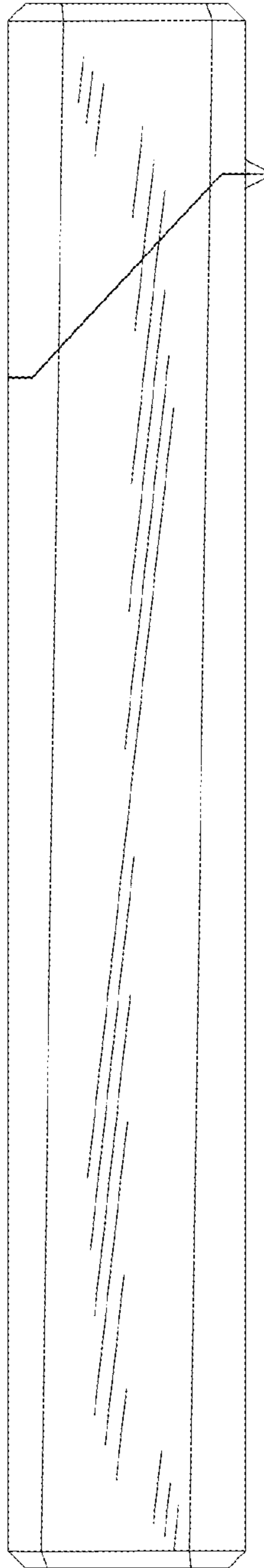

Fig. 15

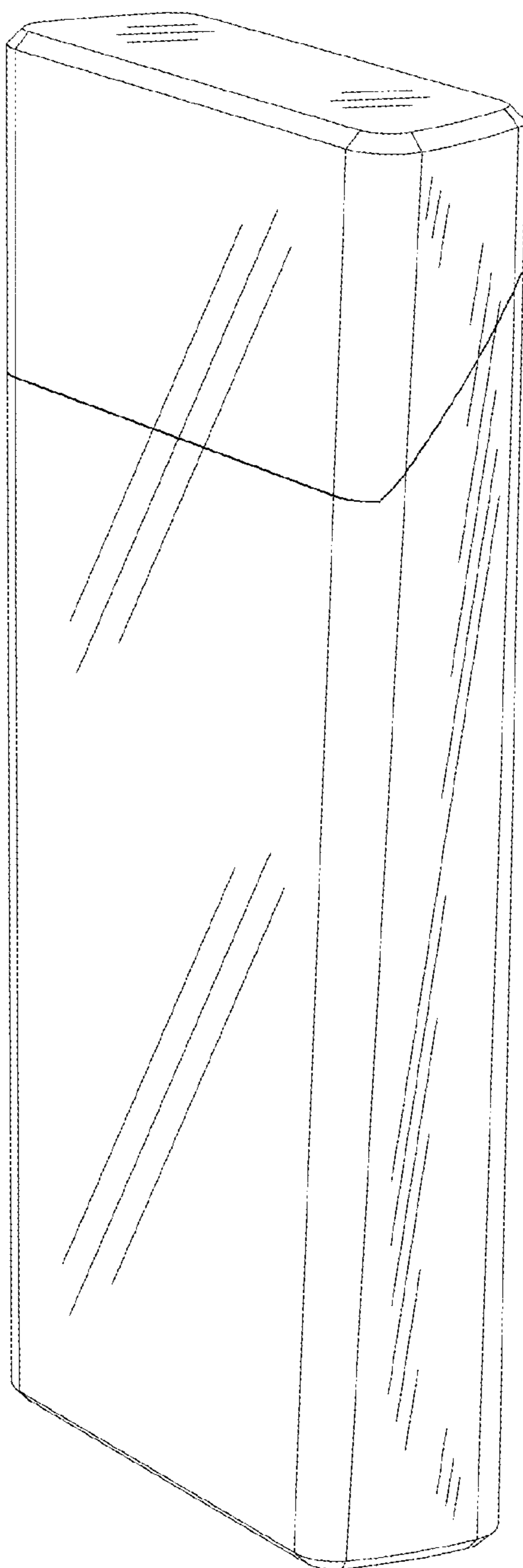

Fig. 16



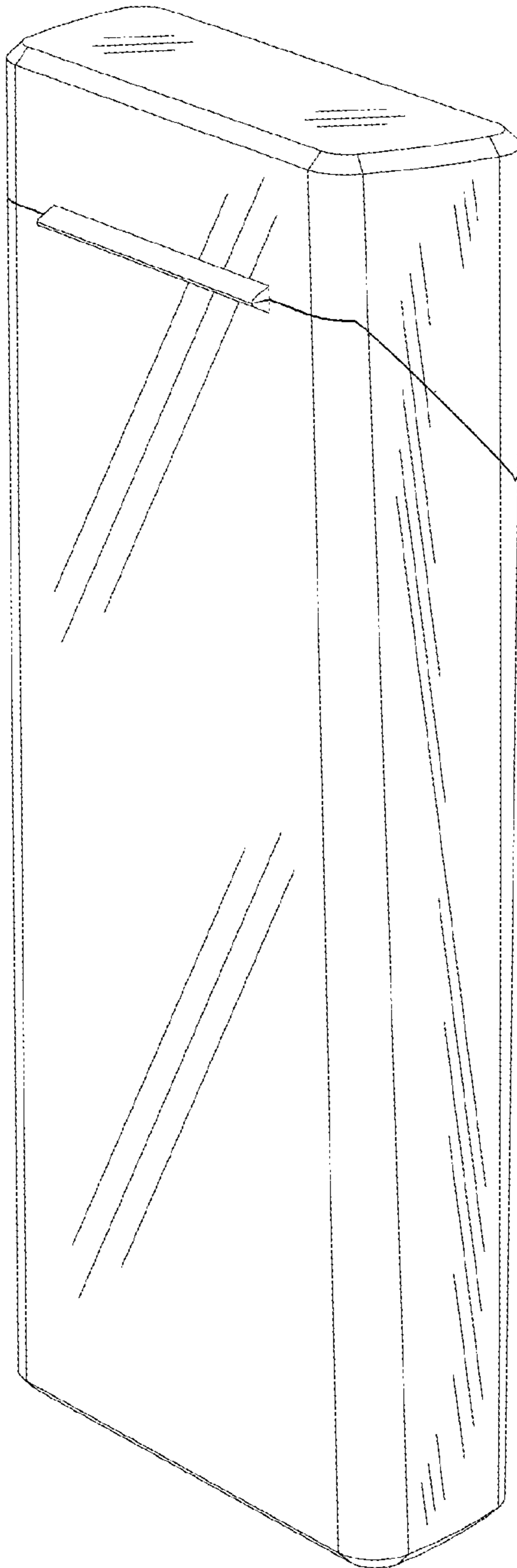

Fig. 17

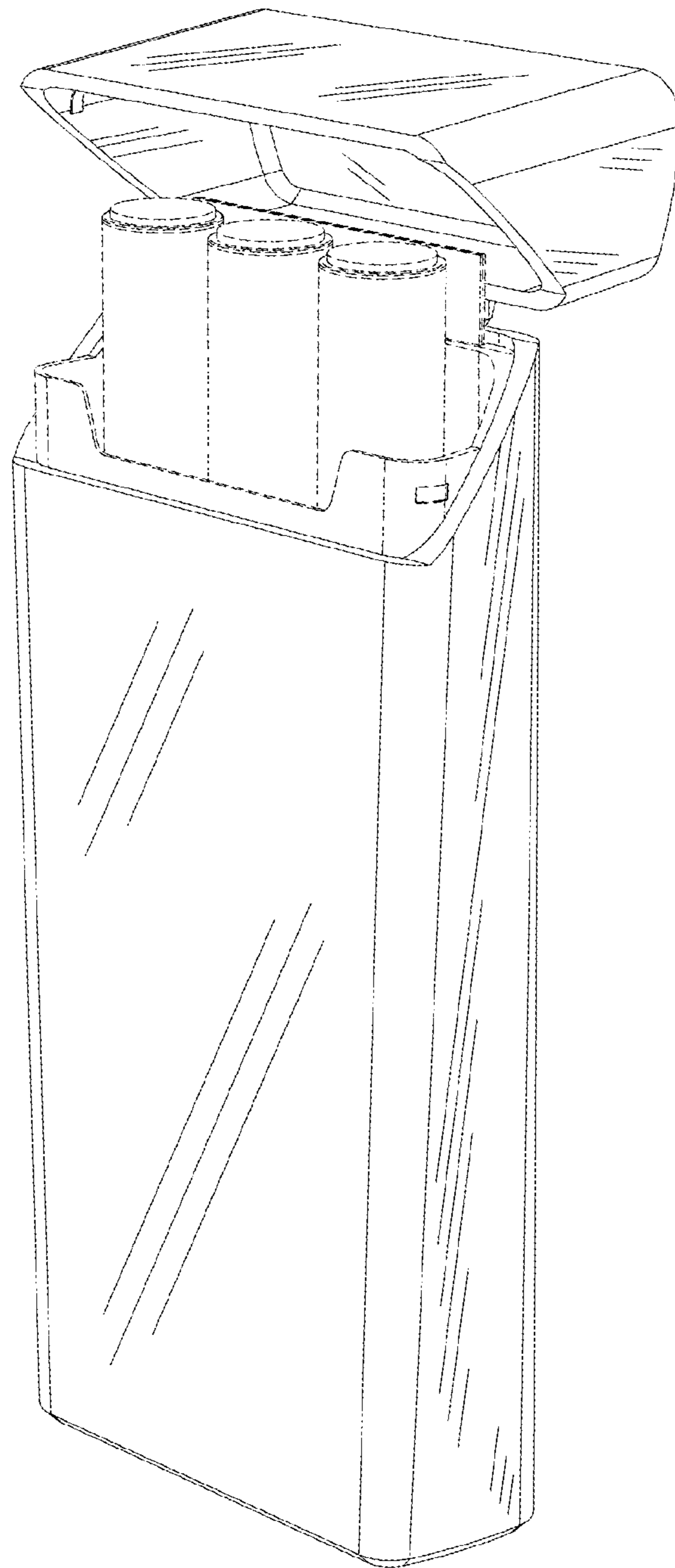

Fig. 18

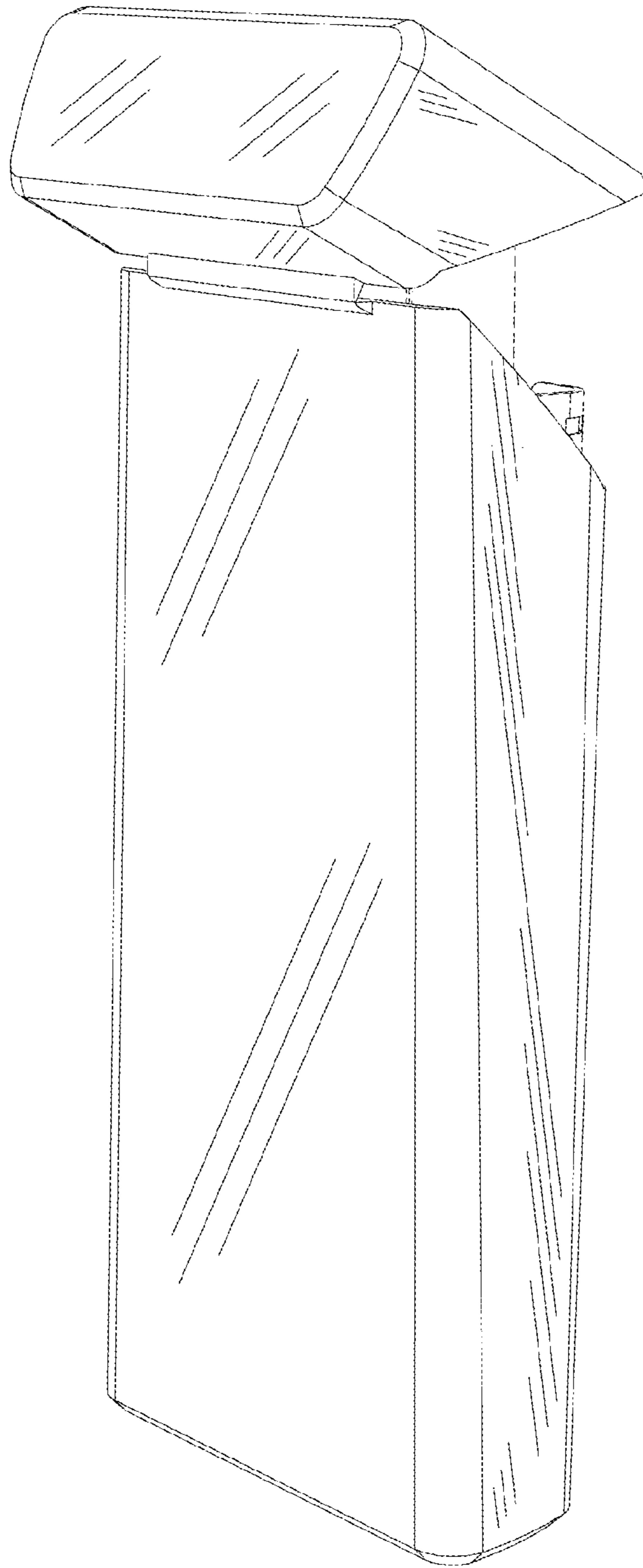

Fig. 19