



US00D737496S

(12) **United States Design Patent**
Swanson

(10) **Patent No.:** **US D737,496 S**

(45) **Date of Patent:** **** Aug. 25, 2015**

(54) **FLOOR LAMP**

(71) Applicant: **Dennis K. Swanson**, Woodland Hills,
CA (US)

(72) Inventor: **Dennis K. Swanson**, Woodland Hills,
CA (US)

(73) Assignee: **LAMPS PLUS, INC.**, Chatsworth, CA
(US)

(**) Term: **14 Years**

(21) Appl. No.: **29/475,363**

(22) Filed: **Dec. 3, 2013**

(51) **LOC (10) Cl.** **26-03**

(52) **U.S. Cl.**
USPC **D26/65**

(58) **Field of Classification Search**
USPC D26/24, 61, 63, 65, 93
CPC F21S 6/00; F21S 6/002; F21S 6/004;
F21S 6/005; F21S 6/008; F21S 8/08; F21V
21/02; F21V 21/14; F21W 2131/30

See application file for complete search history.

(56) **References Cited**

U.S. PATENT DOCUMENTS

4,187,531 A	2/1980	Lowell et al.	
5,221,141 A	6/1993	Swanson	
D370,286 S *	5/1996	Swanson	D26/63
D420,758 S *	2/2000	Yang	D26/65
D426,009 S *	5/2000	Swanson	D26/65
D437,444 S *	2/2001	Swanson	D26/65
D443,092 S *	5/2001	Lo	D26/65

* cited by examiner

Primary Examiner — Brian N Vinson

(74) *Attorney, Agent, or Firm* — Novak Druce Connolly
Bove + Quigg LLP

(57) **CLAIM**

The ornamental design of the floor lamp, as illustrated and
described.

DESCRIPTION

FIG. 1 is a perspective view of the floor lamp;
FIG. 2 is a plan view from the right side thereof;
FIG. 3 is a front plan view thereof;
FIG. 4 is a rear plan view thereof;
FIG. 5 is a plan view from the left side thereof;
FIG. 6 is a top view thereof; and,
FIG. 7 is a bottom view thereof.

1 Claim, 6 Drawing Sheets

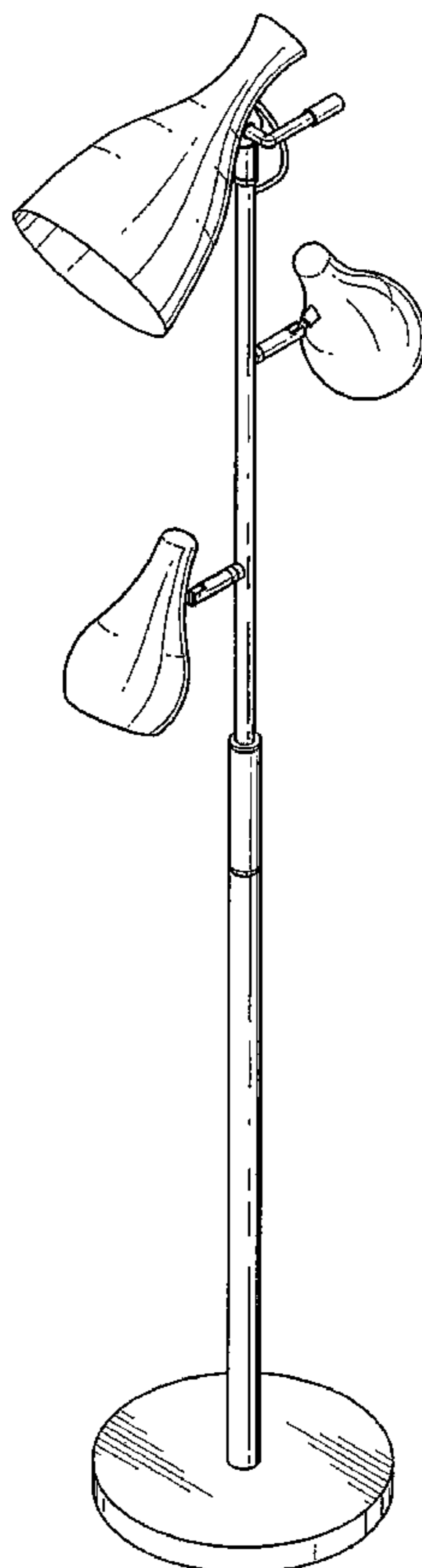

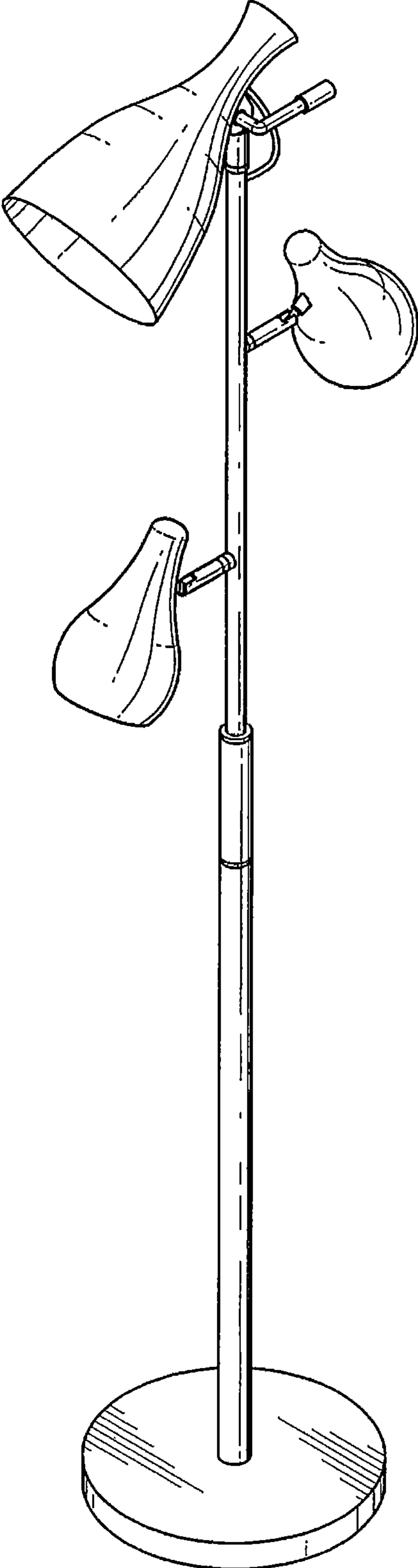

FIG. 1

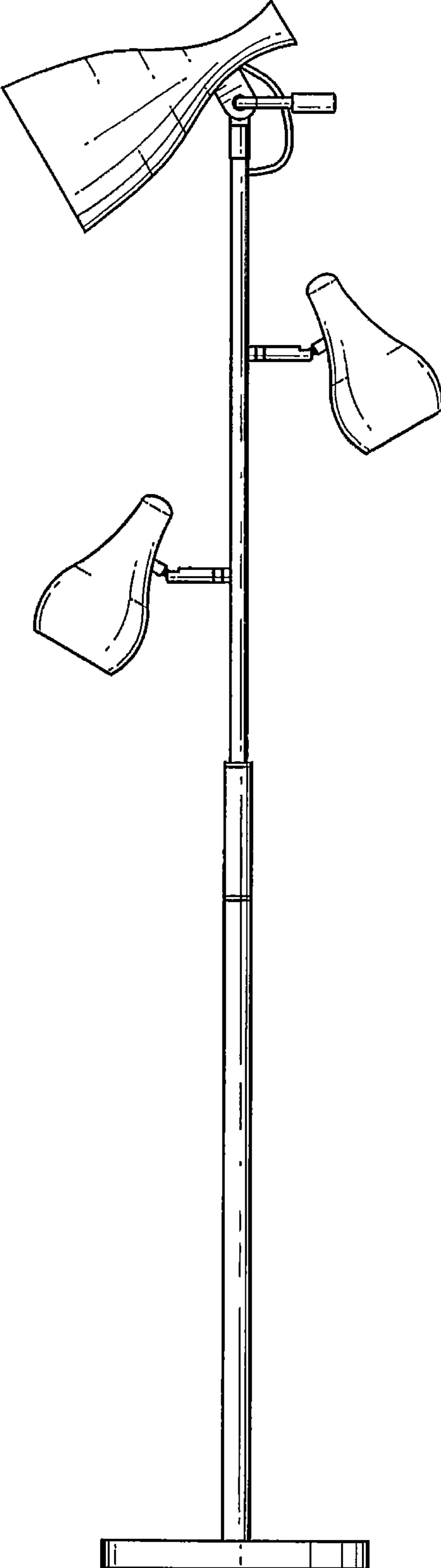

FIG. 2

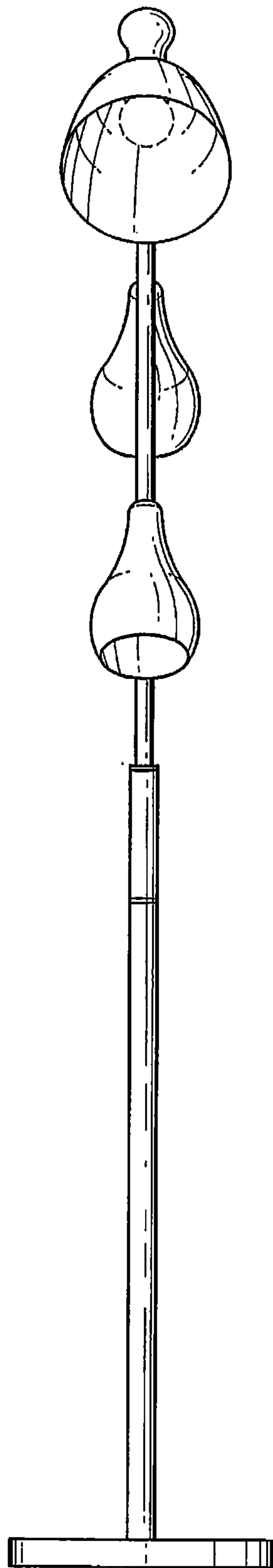

FIG. 3

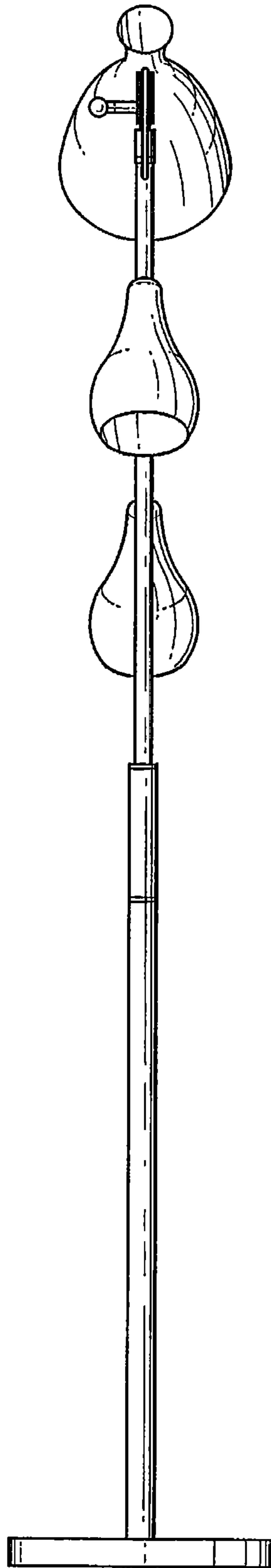

FIG. 4

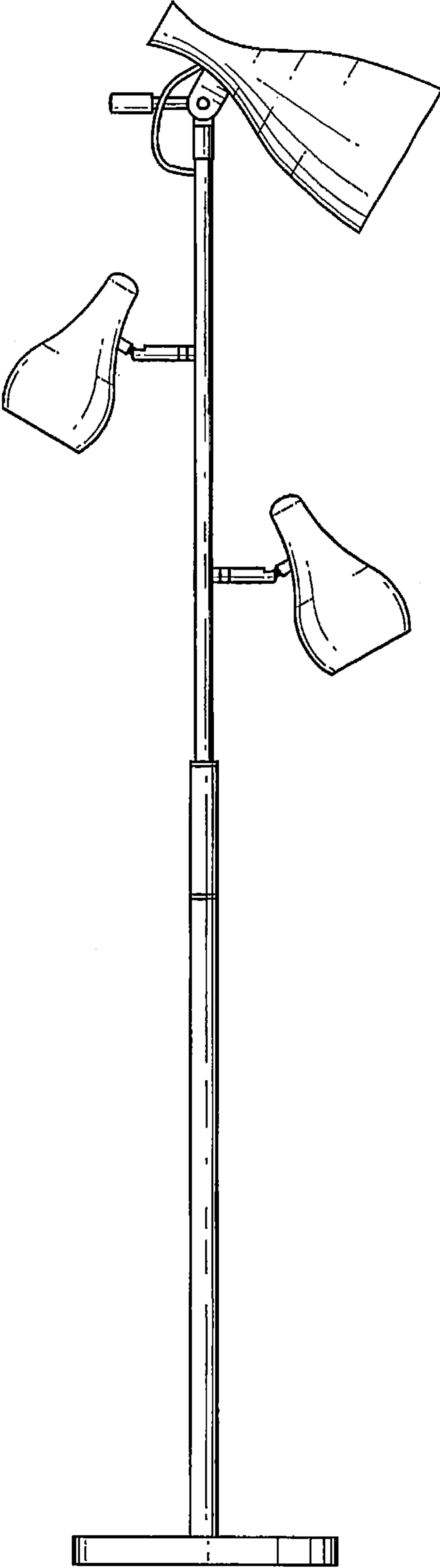

FIG. 5

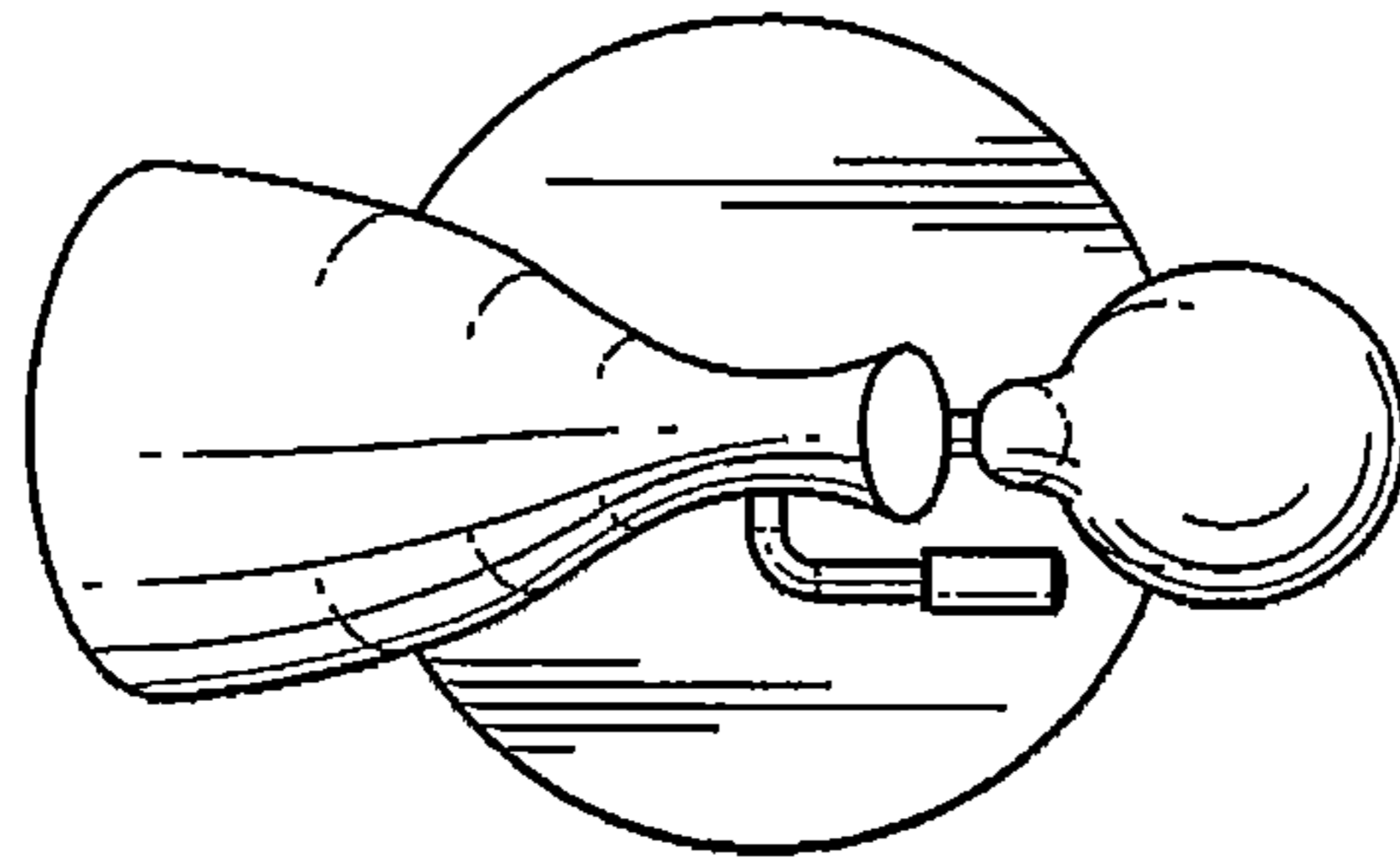

FIG. 6

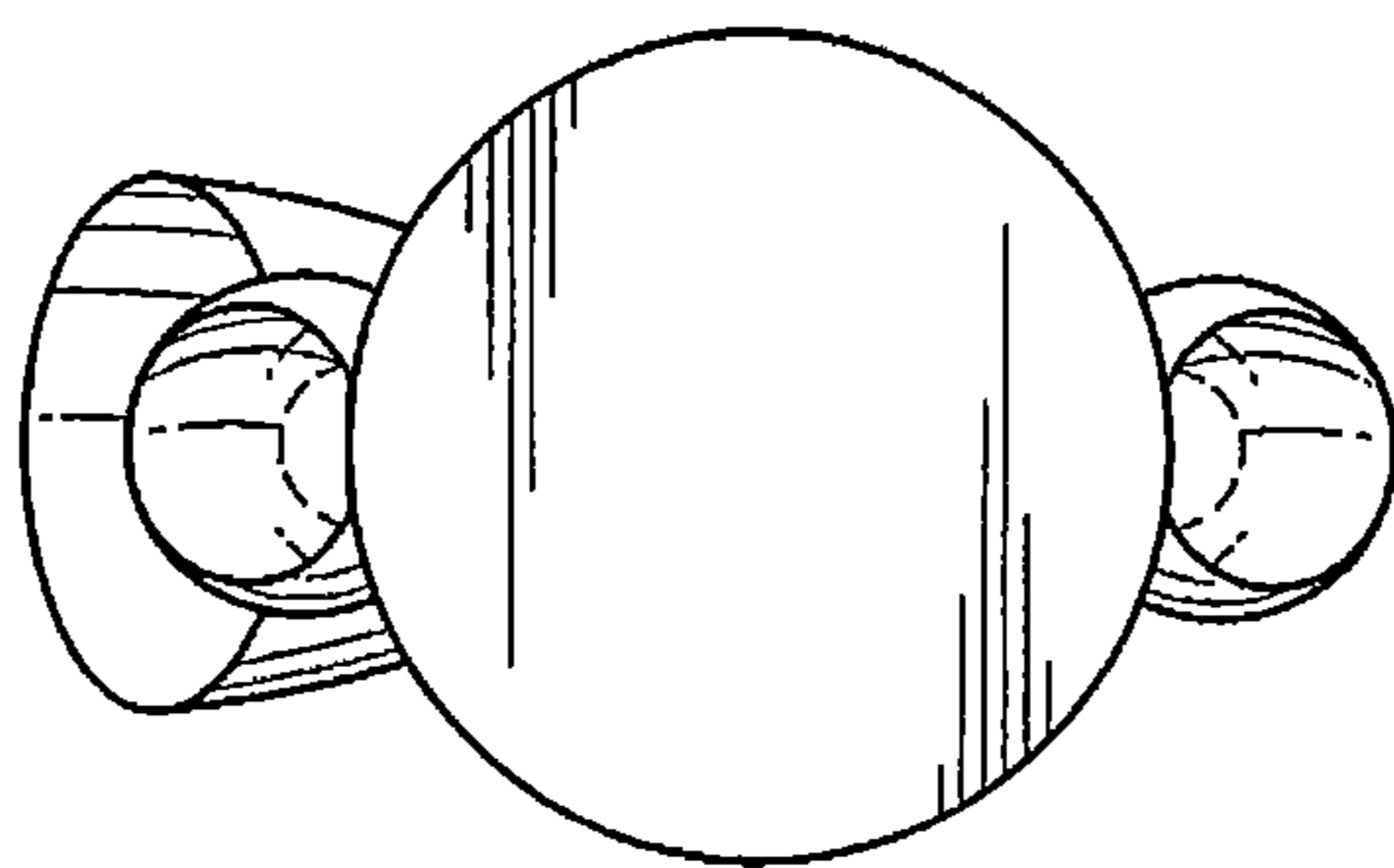

FIG. 7