

US00D737432S

(12) **United States Design Patent**  
**Burke**

(10) **Patent No.:** **US D737,432 S**

(45) **Date of Patent:** **\*\* Aug. 25, 2015**

(54) **MEDICINE APPLICATOR**

(75) Inventor: **John Edward Burke**, Cambridge (GB)

(73) Assignee: **Ferring B.V.**, Hoofddorp (NL)

(\*\*) Term: **14 Years**

(21) Appl. No.: **29/409,618**

(22) Filed: **Dec. 27, 2011**

(30) **Foreign Application Priority Data**

Jun. 27, 2011	(EM)	001883372-0001
Jun. 27, 2011	(EM)	001883372-0002
Jun. 27, 2011	(EM)	001883372-0003
Jun. 27, 2015	(EM)	001883372-0004

(51) **LOC (10) Cl.** ..... **24-02**

(52) **U.S. Cl.**  
USPC ..... **D24/119**

(58) **Field of Classification Search**

USPC ..... D24/119, 114, 112, 113, 186, 130, 127;  
D9/729; 604/310, 181, 232, 208, 189,  
604/132, 136; 606/181, 185; 222/39;  
401/265, 261, 11  
CPC ..... B65D 35/36; B65D 47/42; A61D 7/00;  
A61F 2007/029; A45D 34/042; A61M 35/006  
See application file for complete search history.

(56) **References Cited**

**U.S. PATENT DOCUMENTS**

D519,633	S *	4/2006	Weekes et al.	.....	D24/112
D613,399	S *	4/2010	Hunter et al.	.....	D24/130
D655,001	S *	2/2012	Becker et al.	.....	D24/130
D677,382	S *	3/2013	Foley et al.	.....	D24/114
8,544,684	B2 *	10/2013	Perez	.....	222/39

8,684,968	B2 *	4/2014	Genosar	.....	604/132
D708,317	S *	7/2014	Schneider et al.	.....	D24/113
2007/0293883	A1 *	12/2007	Horie	.....	606/181
2008/0101850	A1 *	5/2008	Wojcik et al.	.....	401/265
2013/0274668	A1 *	10/2013	Barrow-Williams et al.	.....	604/136
2014/0221943	A1 *	8/2014	Carrara et al.	.....	604/310
2014/0263425	A1 *	9/2014	Akdogan et al.	.....	222/39

**OTHER PUBLICATIONS**

U.S. Appl. No. 61/501,292, filed Jun. 27, 2011.

\* cited by examiner

*Primary Examiner* — Sheryl Lane

*Assistant Examiner* — Nicole Shiflet

(74) *Attorney, Agent, or Firm* — Fish & Richardson P.C.

(57) **CLAIM**

The ornamental design for a medicine applicator, as shown and described.

**DESCRIPTION**

FIG. 1 is a perspective view of the medicine applicator of the present invention without a medicine bottle.

FIG. 2 is a perspective view of the medicine applicator of FIG. 1 without a medicine bottle, and with the lid removed.

FIG. 3 is a front view of the medicine applicator of FIG. 1.

FIG. 4 is a rear view of the medicine applicator of FIG. 1.

FIG. 5 is a left side view of the medicine applicator of FIG. 1.

FIG. 6 is a right side view of the medicine applicator of FIG. 1.

FIG. 7 is a top view of the medicine applicator with the lid on of FIG. 1.

FIG. 8 is a bottom view of the medicine applicator of FIG. 1; and,

FIG. 9 is a top view of the medicine applicator of FIG. 1 with the lid off.

**1 Claim, 6 Drawing Sheets**

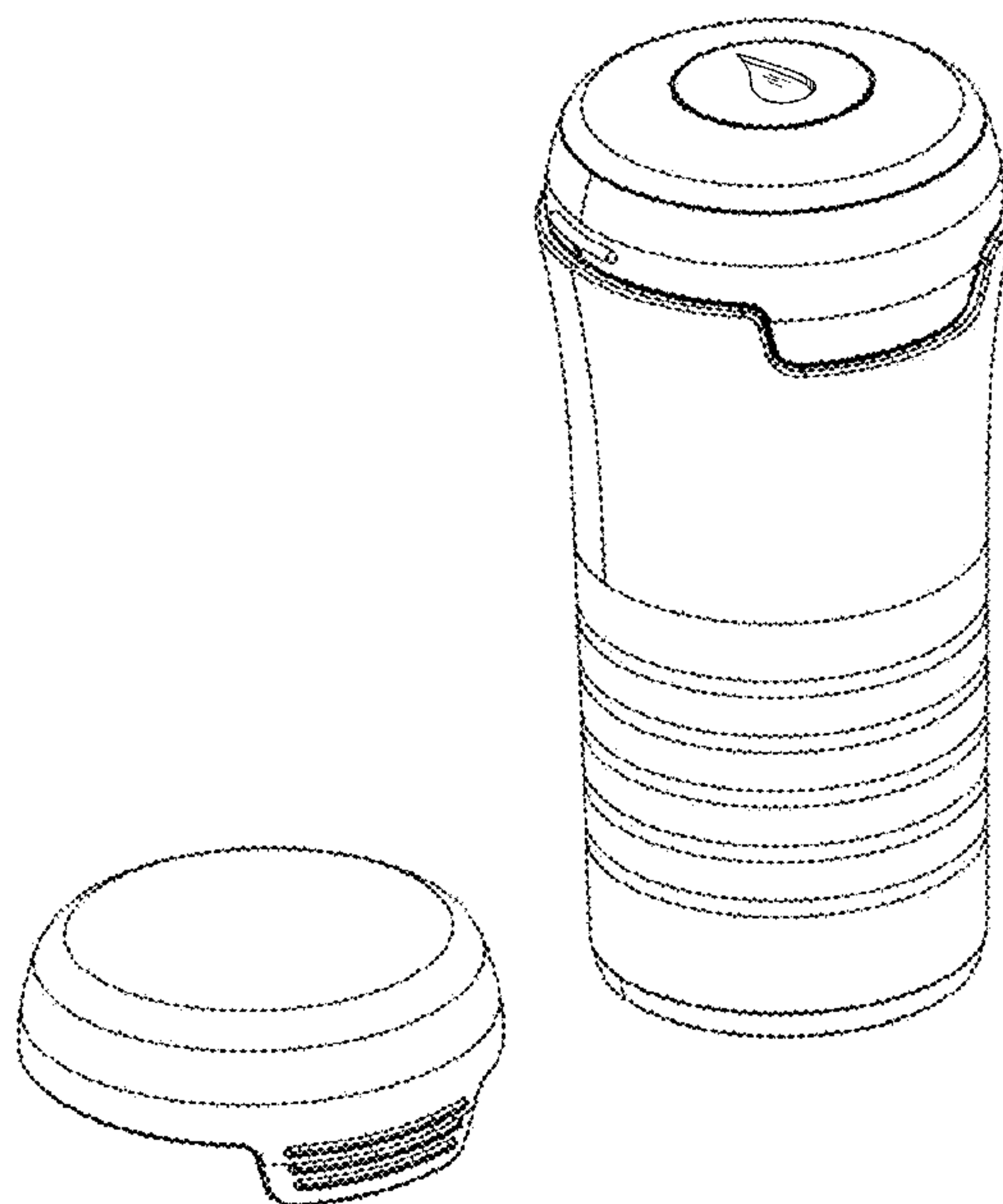

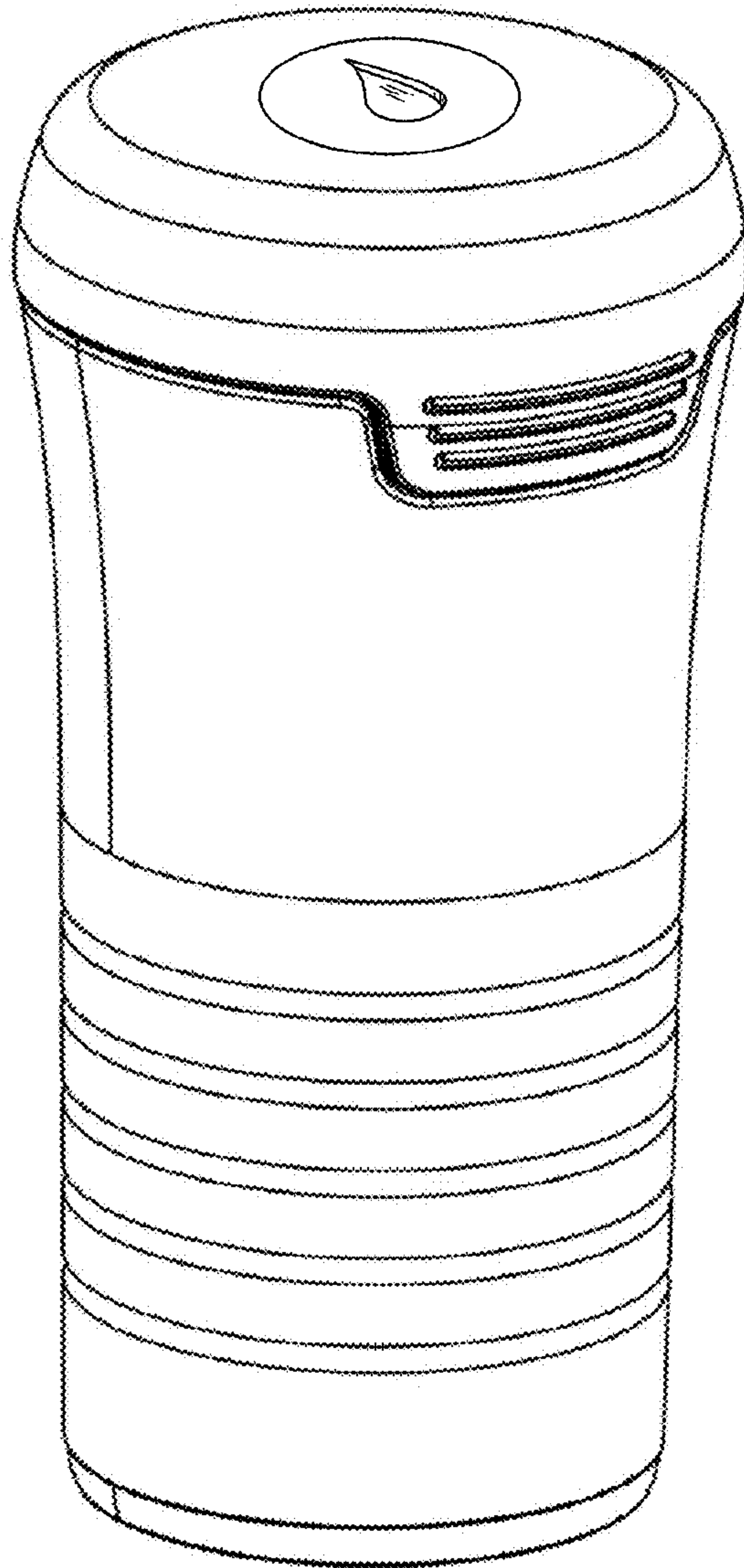

FIG. 1

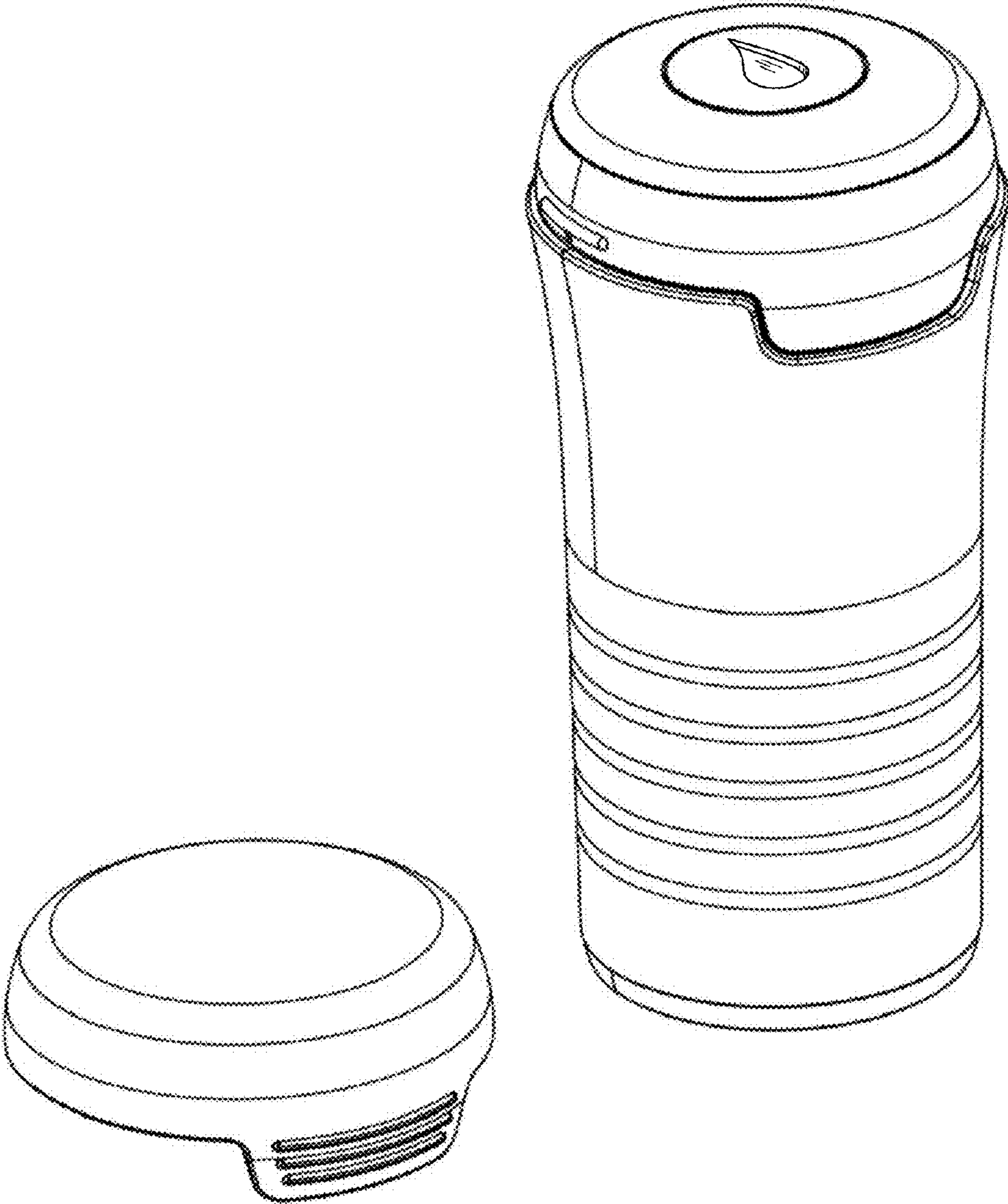

FIG. 2

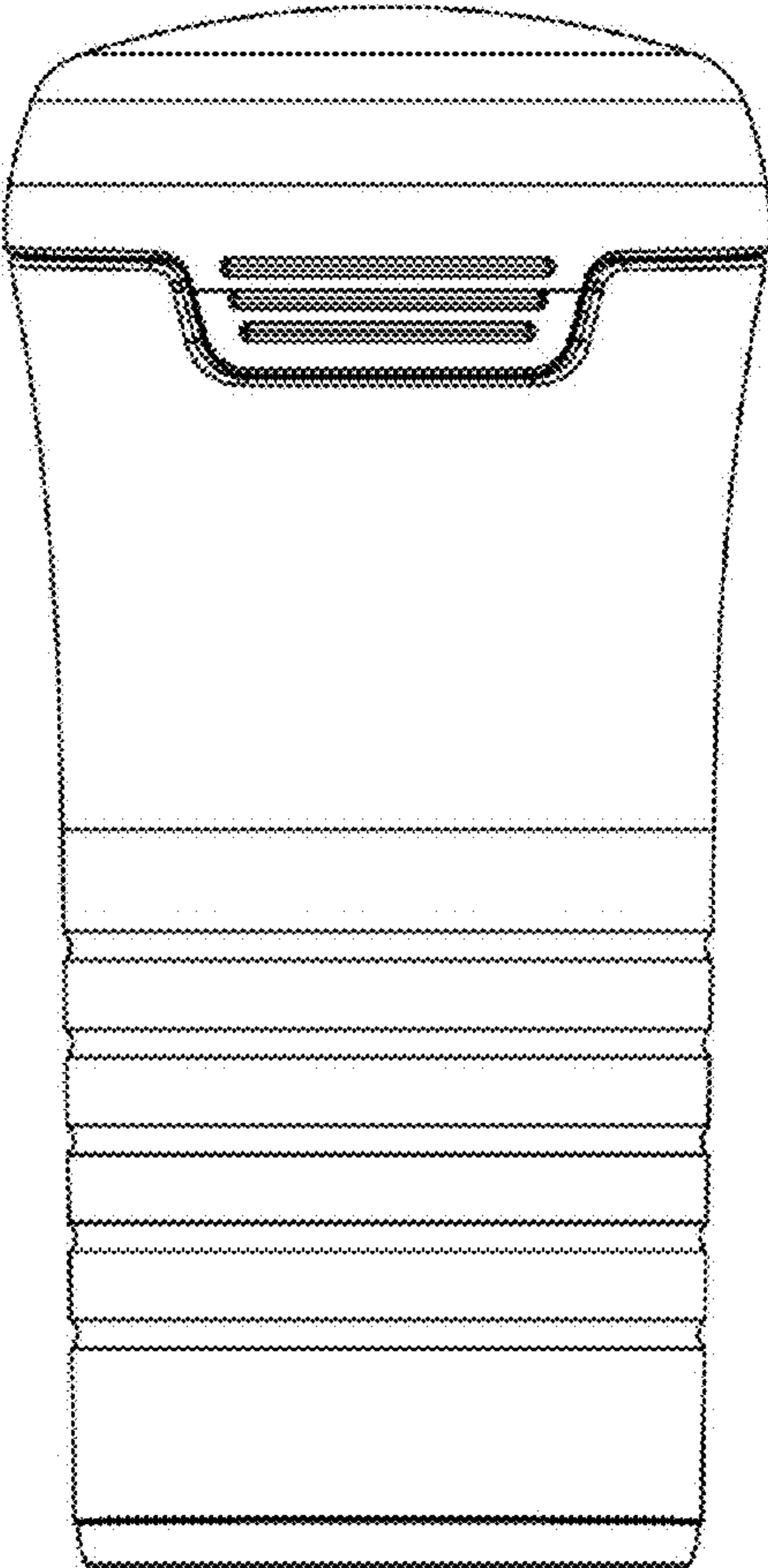

FIG. 3

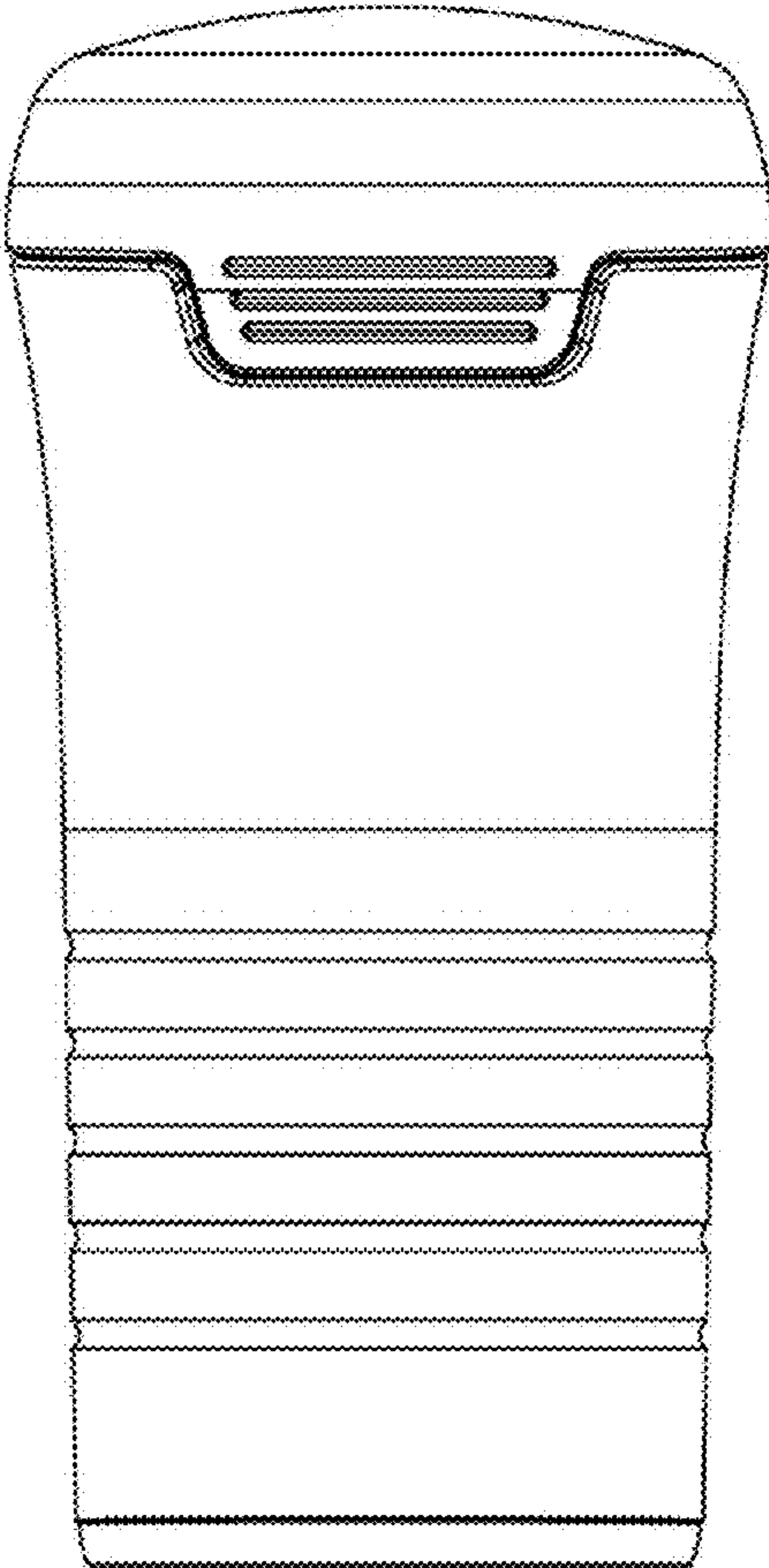

FIG. 4



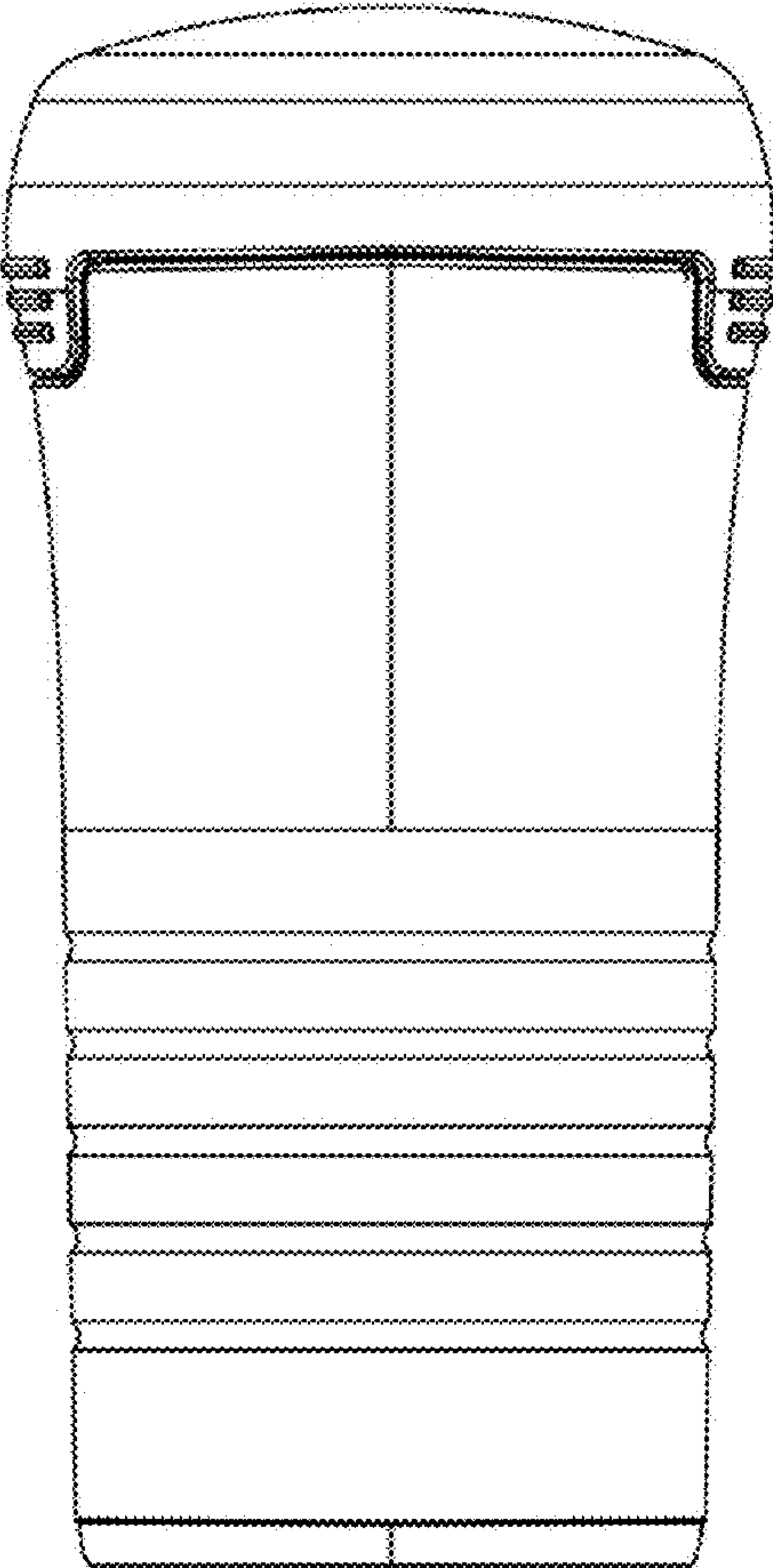

FIG. 5

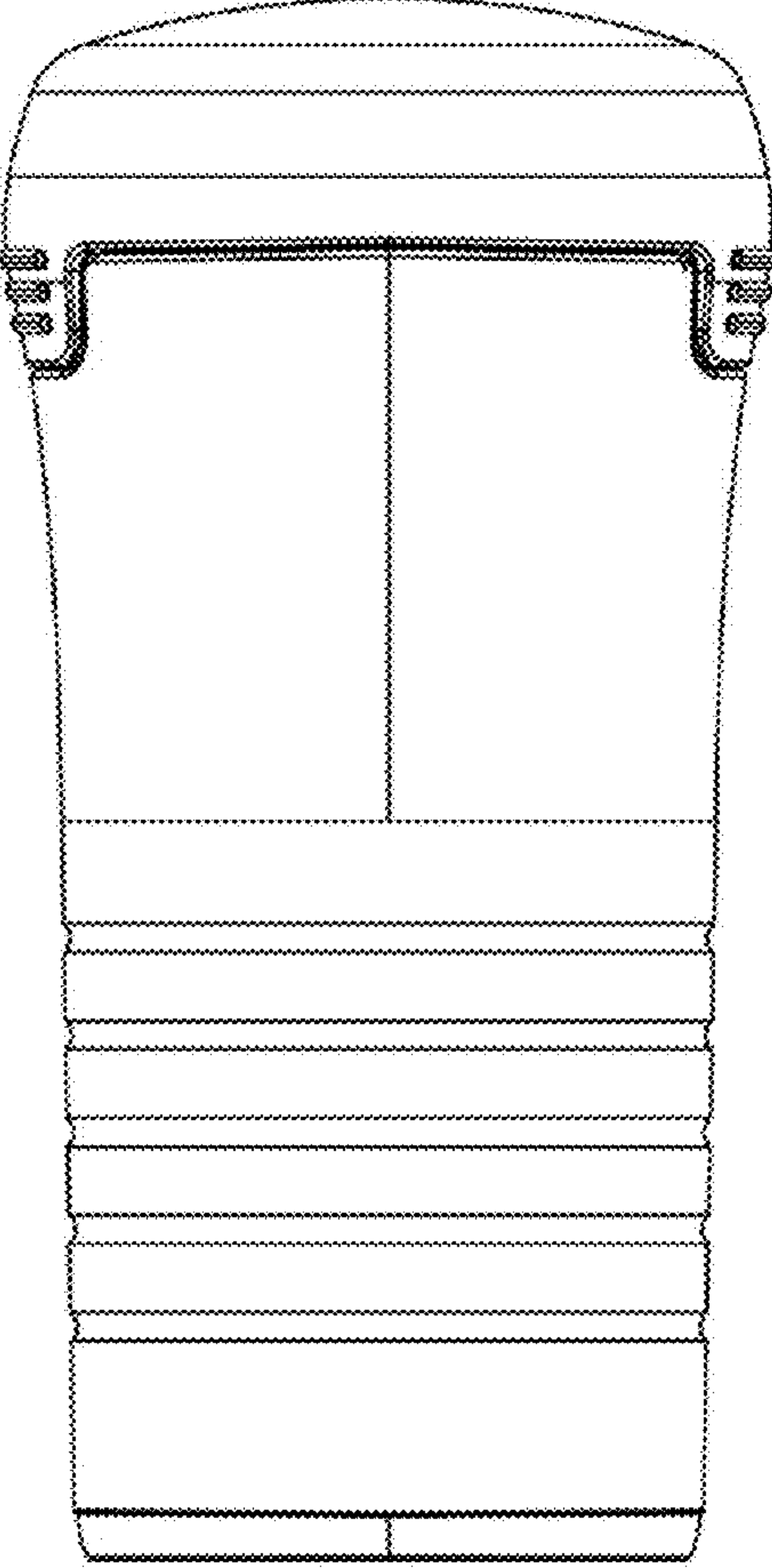

FIG. 6

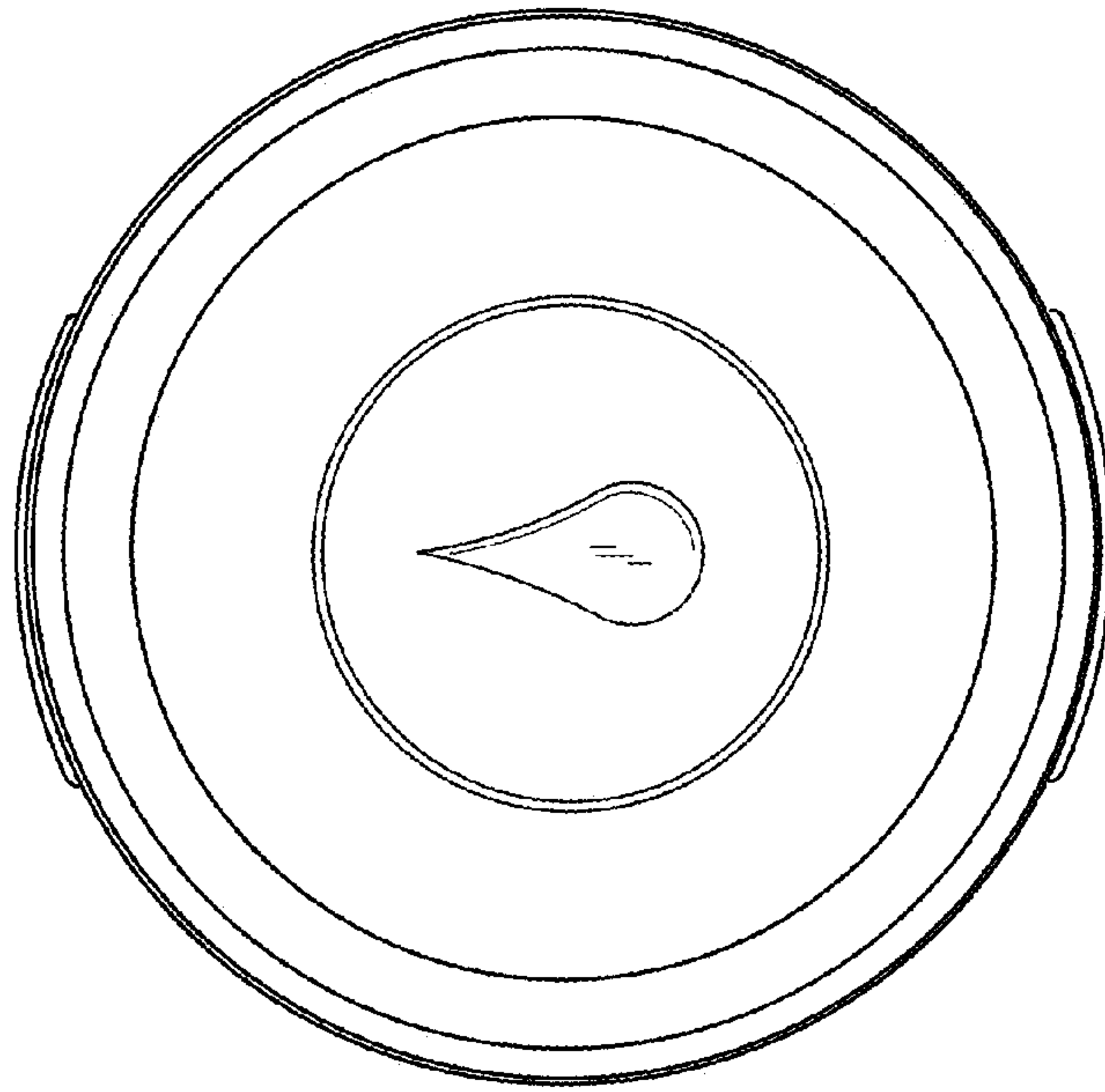

FIG. 7

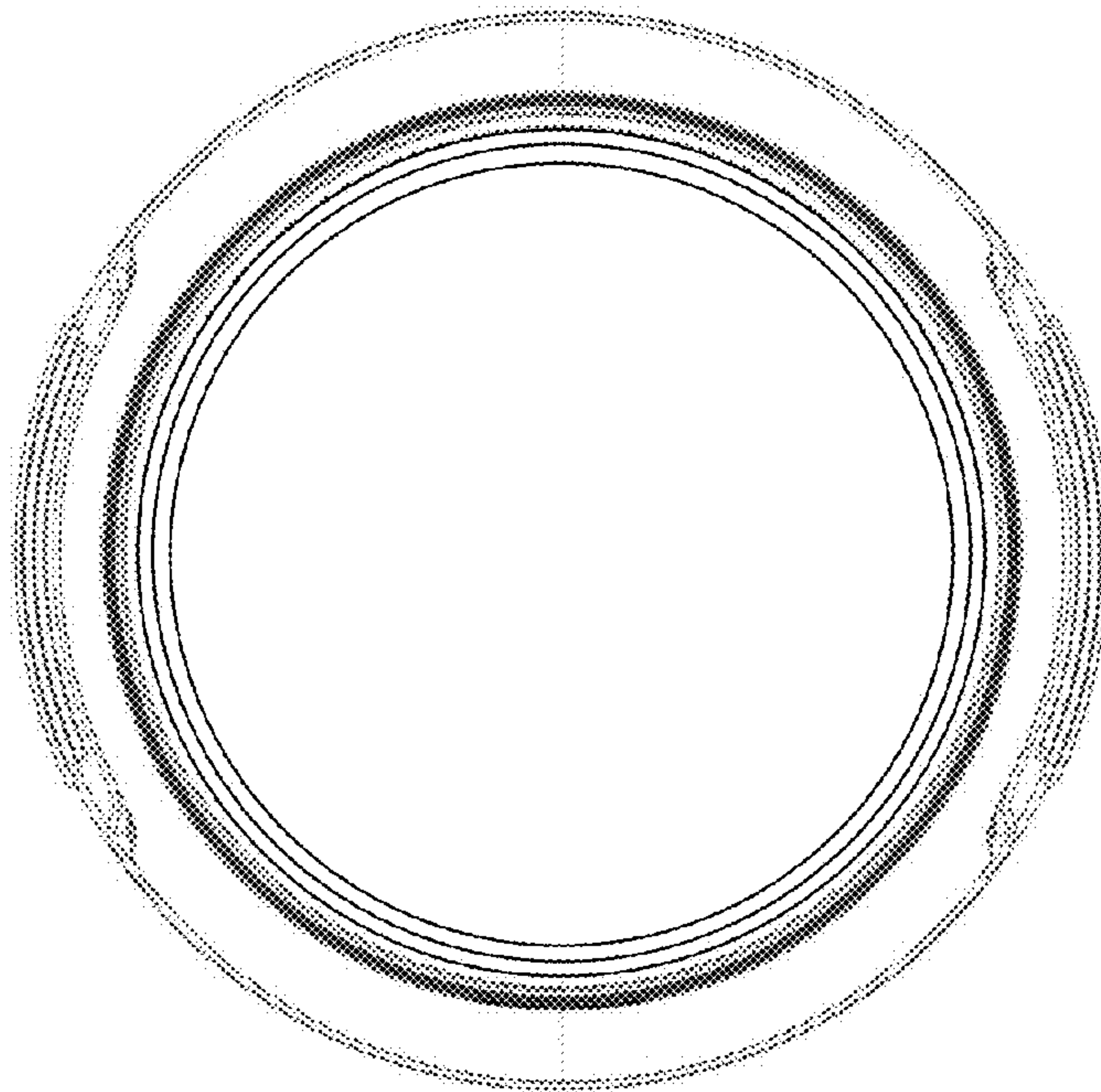

FIG. 8

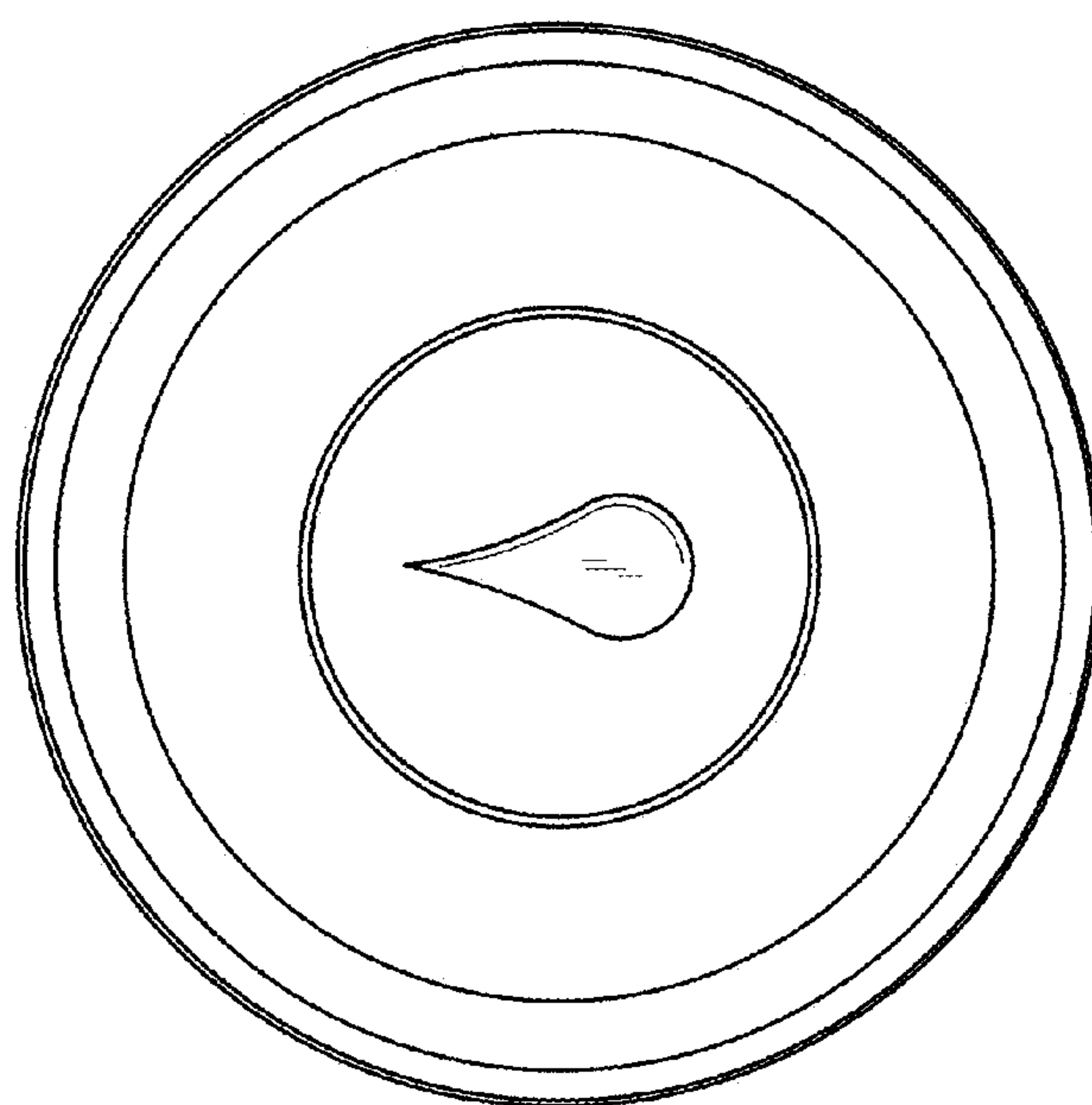

FIG. 9