



US00D737247S

(12) **United States Design Patent**
Billington

(10) **Patent No.:** **US D737,247 S**

(45) **Date of Patent:** **** Aug. 25, 2015**

(54) **PORTABLE LOUD SPEAKER**

(71) Applicant: **Charles Billington**, London (GB)

(72) Inventor: **Charles Billington**, London (GB)

(73) Assignee: **Groundhog S.A.**, Luxembourg (LU)

(**) Term: **14 Years**

(21) Appl. No.: **29/487,362**

(22) Filed: **Apr. 8, 2014**

(30) **Foreign Application Priority Data**

Oct. 30, 2013 (EM) 002336131-0003

(51) **LOC (10) Cl.** **14-03**

(52) **U.S. Cl.**
USPC **D14/216**; D14/210

(58) **Field of Classification Search**
USPC D14/167, 168, 170–172, 188, 194–196,
D14/204, 207, 209.1, 210–216, 219, 221,
D14/222, 224, 496; 181/143, 144, 147, 148,
181/150, 153, 157, 198, 199; 381/300–303,
381/306, 332, 333, 336, 345, 361–364,
381/386–388; 369/6–12

CPC B60R 11/0217; G06F 1/1688; H04M 1/03;
H04M 1/035; H04R 1/02; H04R 1/06; H04R
1/021; H04R 1/025; H04R 1/026; H04R
1/028; H04R 1/105; H04R 1/323; H04R
1/403; H04R 1/2803; H04R 1/2834; H04R
5/02; H04R 7/20; H04R 9/06; H04R 9/025;
H04R 2201/021; H04R 2400/00; H04R
2400/07; H04R 2499/11; H04R 2499/13;
H04R 2499/15; H04S 3/00; H04S 7/30

See application file for complete search history.

(56) **References Cited**

U.S. PATENT DOCUMENTS

D573,134	S	*	7/2008	Milks et al.	D14/214
D581,569	S	*	11/2008	Levine	D26/61
D678,244	S	*	3/2013	Behar et al.	D14/214
D678,864	S	*	3/2013	Behar et al.	D14/214
D678,865	S	*	3/2013	Behar et al.	D14/214
D692,860	S	*	11/2013	Paterson	D14/214
D692,861	S	*	11/2013	Paterson	D14/214
D719,932	S	*	12/2014	Osborn et al.	D14/214
D723,515	S	*	3/2015	Ang et al.	D14/214
D726,684	S	*	4/2015	Schmiedbauer	D14/210
D726,685	S	*	4/2015	Cheng	D14/212
D730,319	S	*	5/2015	Behar et al.	D14/214
D730,320	S	*	5/2015	Behar et al.	D14/214
D730,321	S	*	5/2015	Behar et al.	D14/214
D730,870	S	*	6/2015	Behar et al.	D14/214
D731,462	S	*	6/2015	Behar et al.	D14/214

* cited by examiner

Primary Examiner — Keli L Hill

(74) *Attorney, Agent, or Firm* — Douglas L. Weller

(57) **CLAIM**

The ornamental design for a portable loud speaker, as shown and described.

DESCRIPTION

FIG. 1 is a top plan view of the portable loud speaker.
FIG. 2 is a right side elevational view of the portable loud speaker, the left being a mirror image of the right.
FIG. 3 is a front elevational view of the portable loud speaker.
FIG. 4 is a rear elevational view of the portable loud speaker.
FIG. 5 is a bottom plan view of the portable loud speaker.
FIG. 6 is a top front right perspective view of the portable loud speaker; and,
FIG. 7 is a top rear right perspective view of the portable loud speaker.

1 Claim, 2 Drawing Sheets

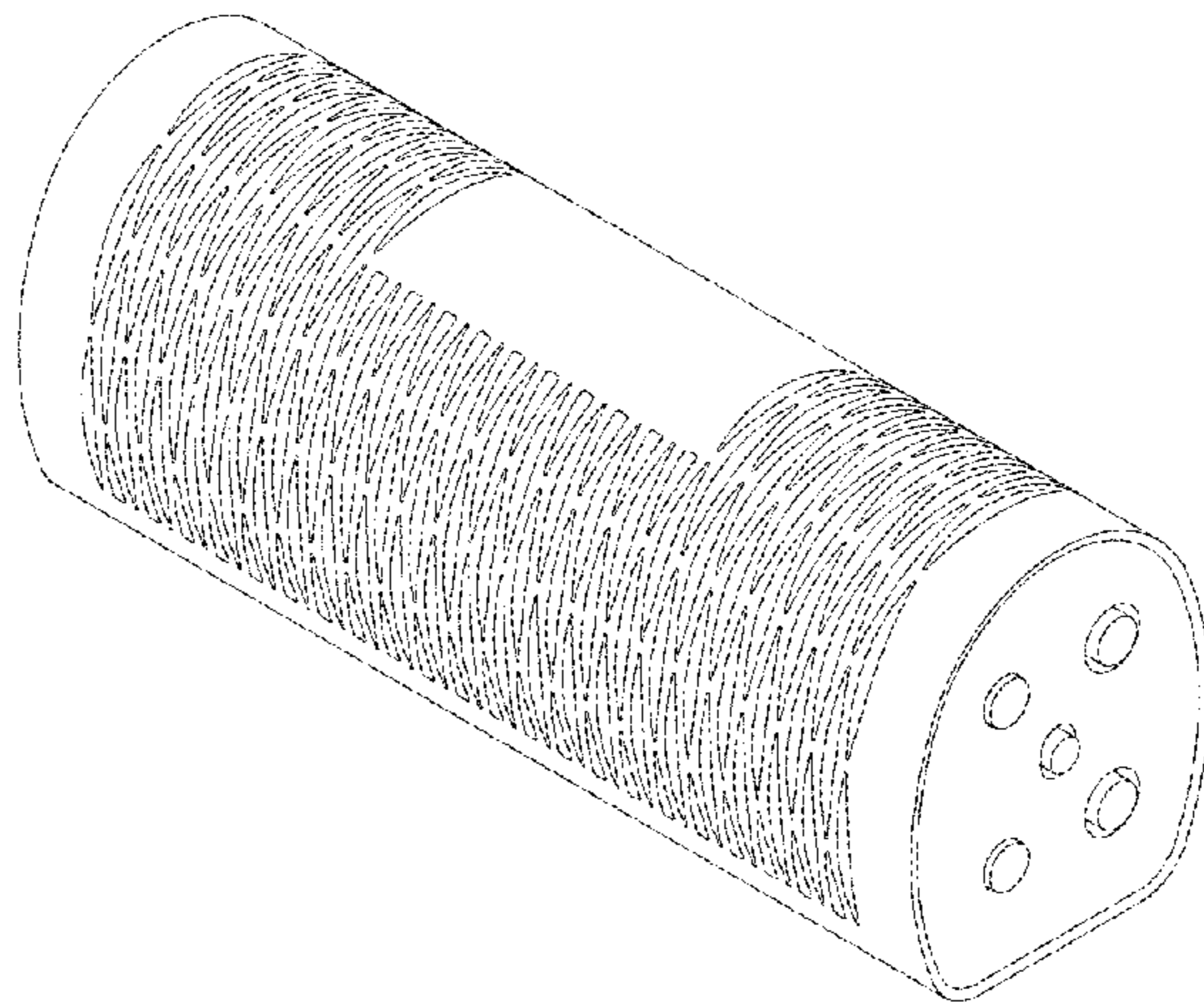
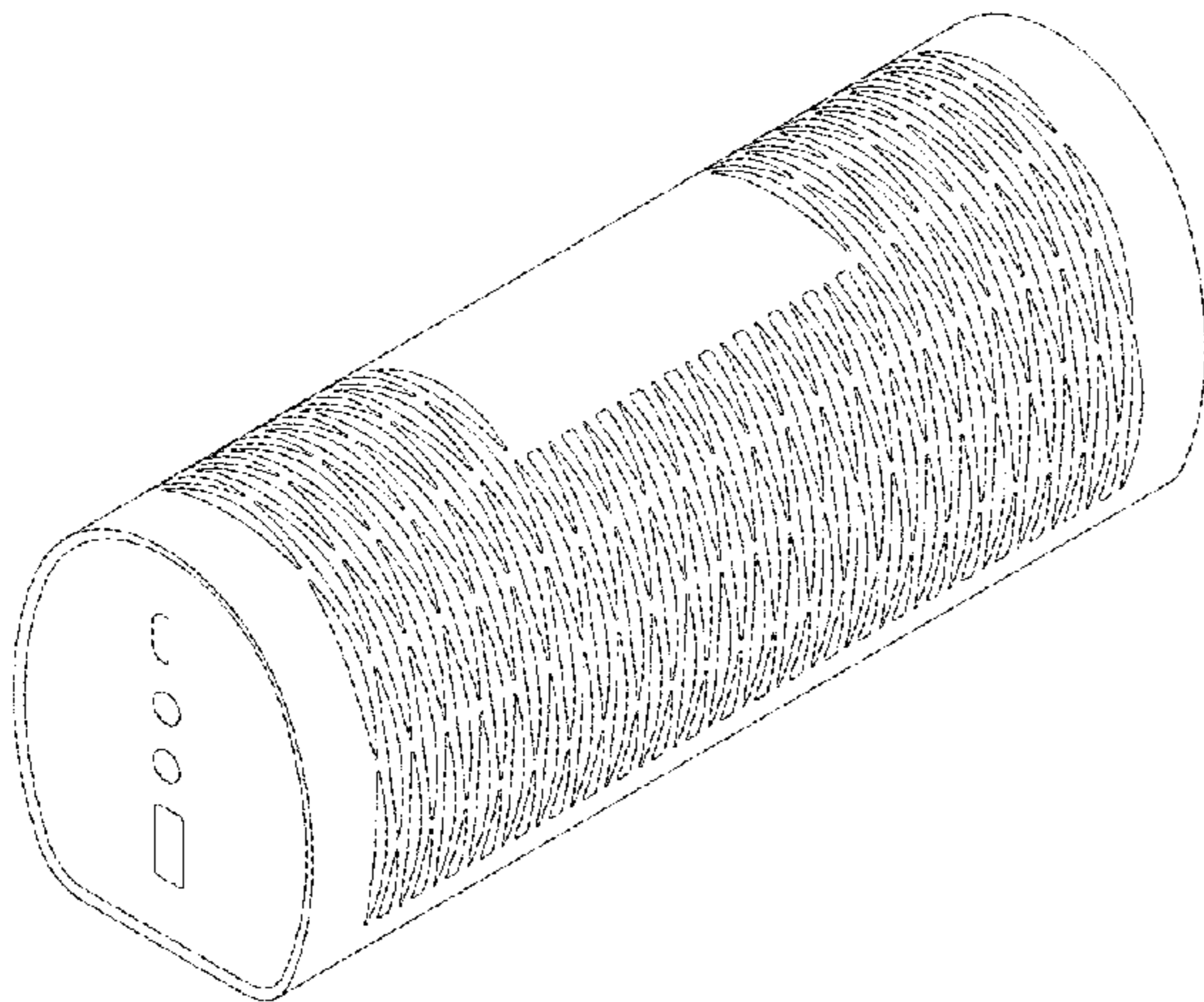

FIG.1

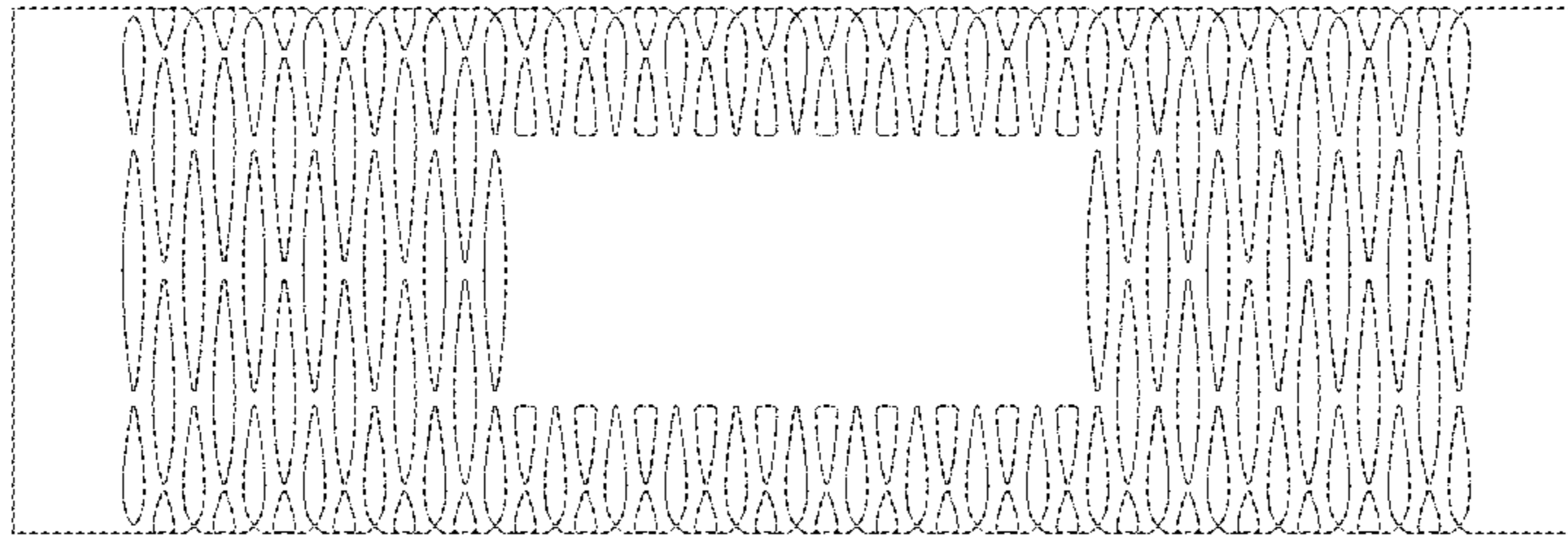

FIG.2

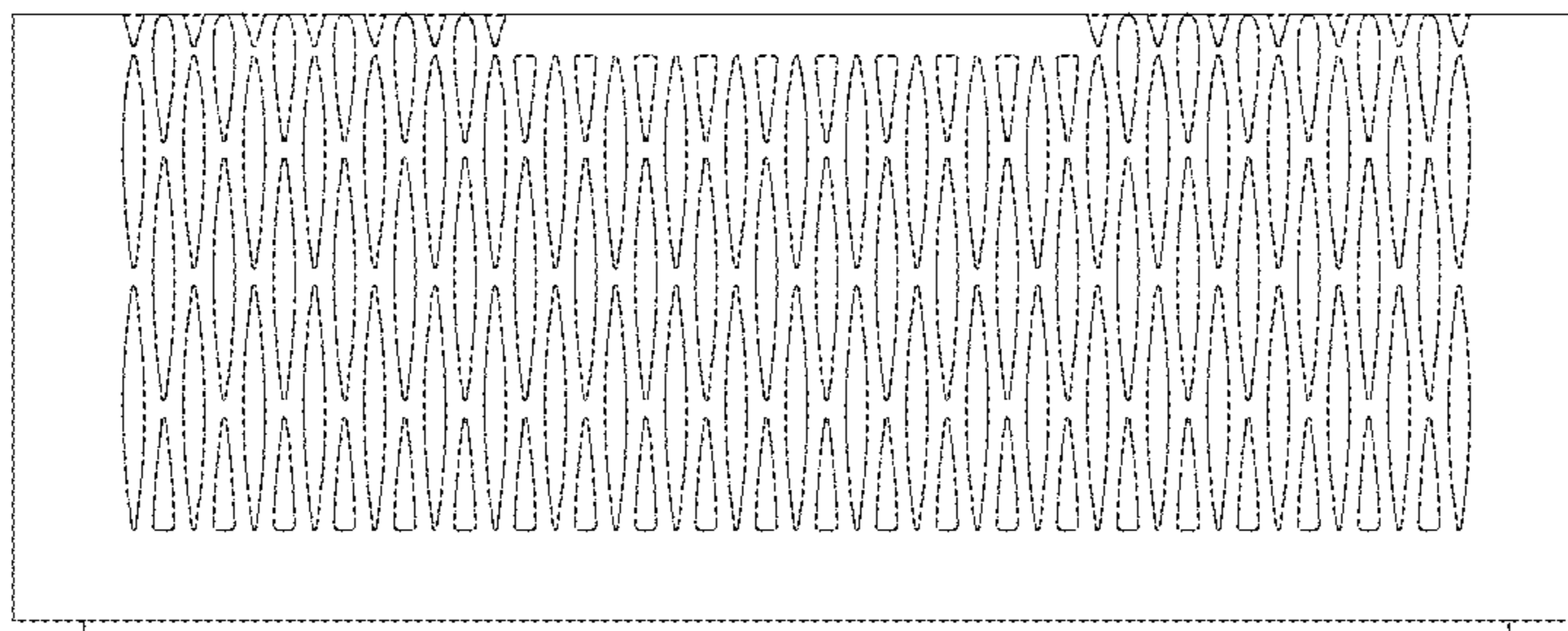

FIG.3

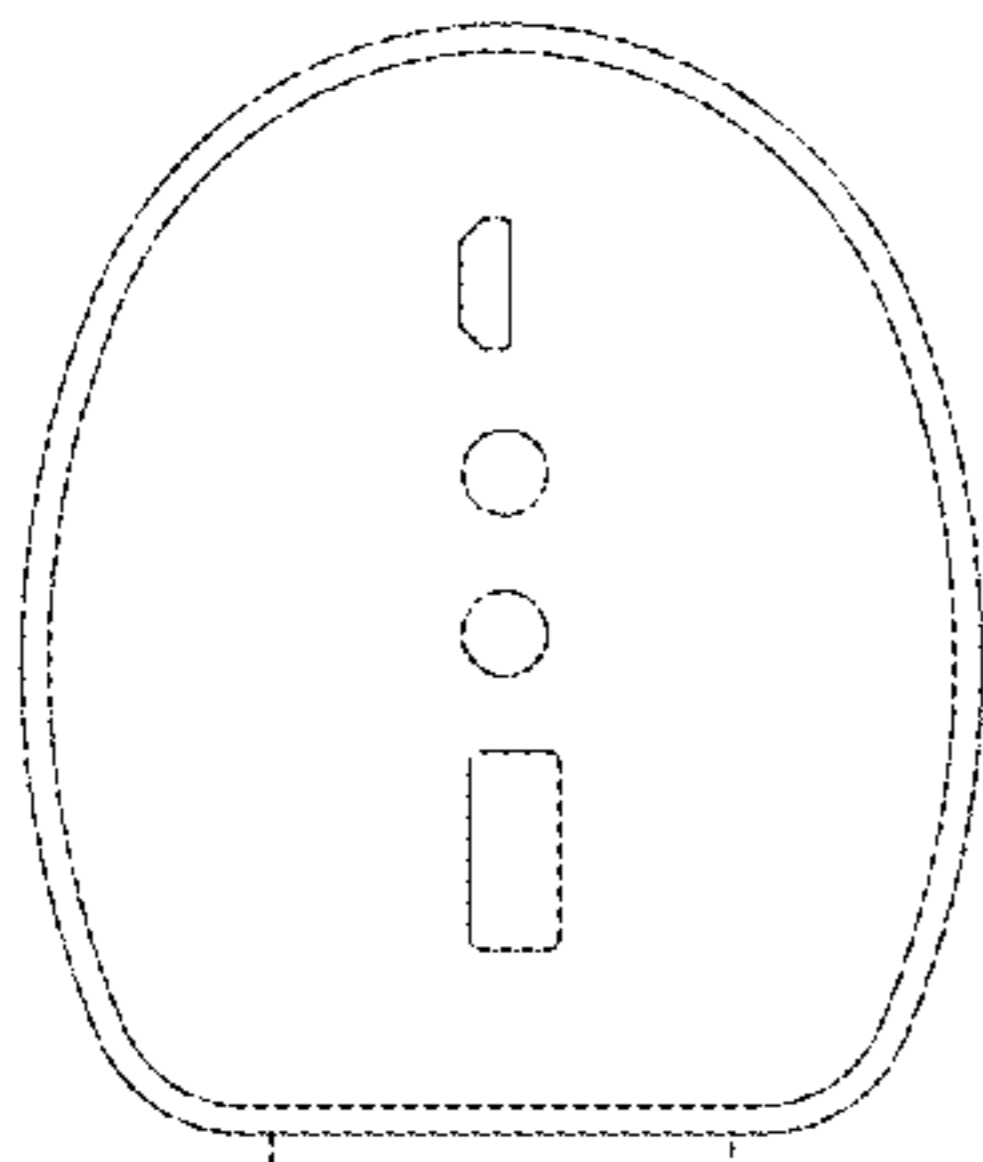

FIG.4

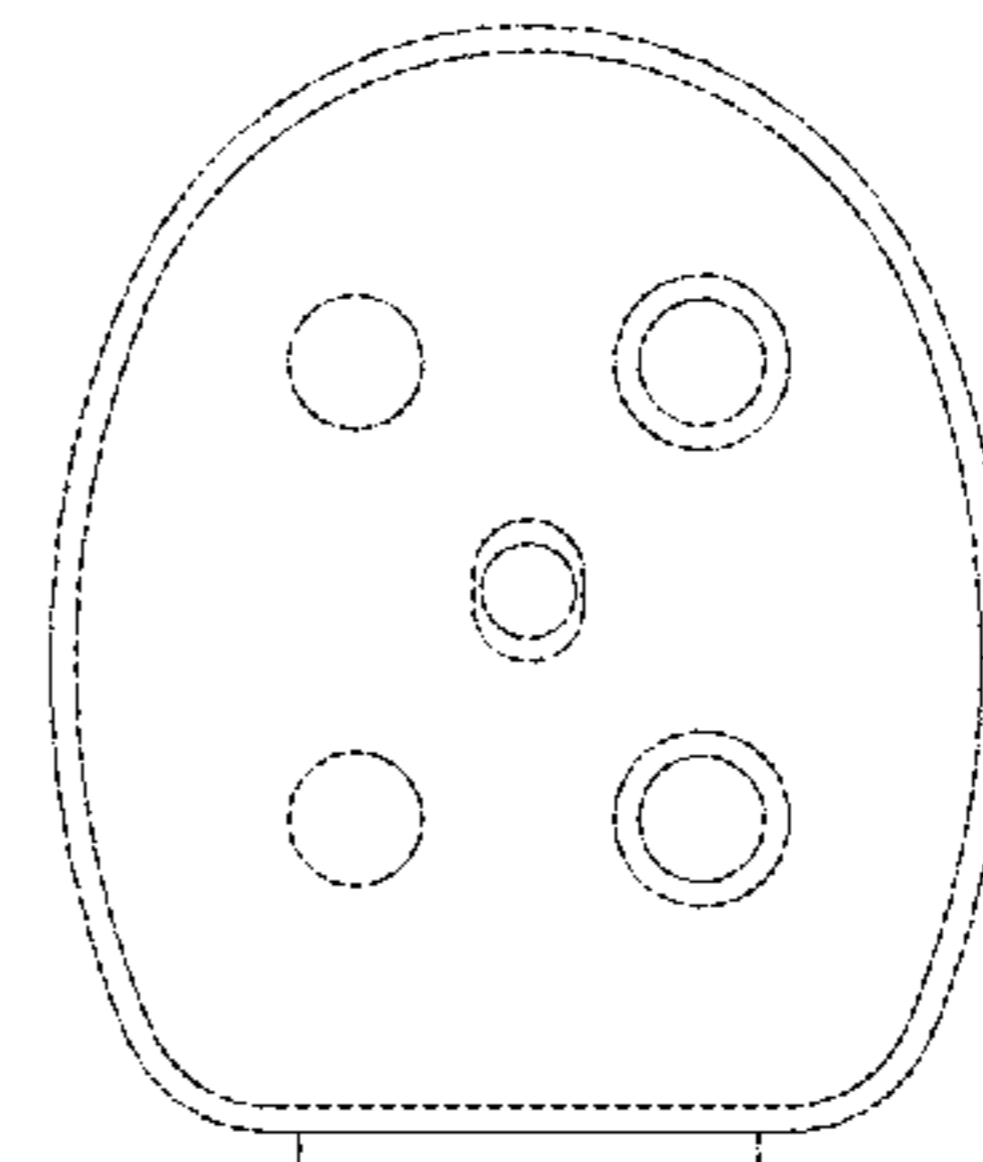

FIG.5

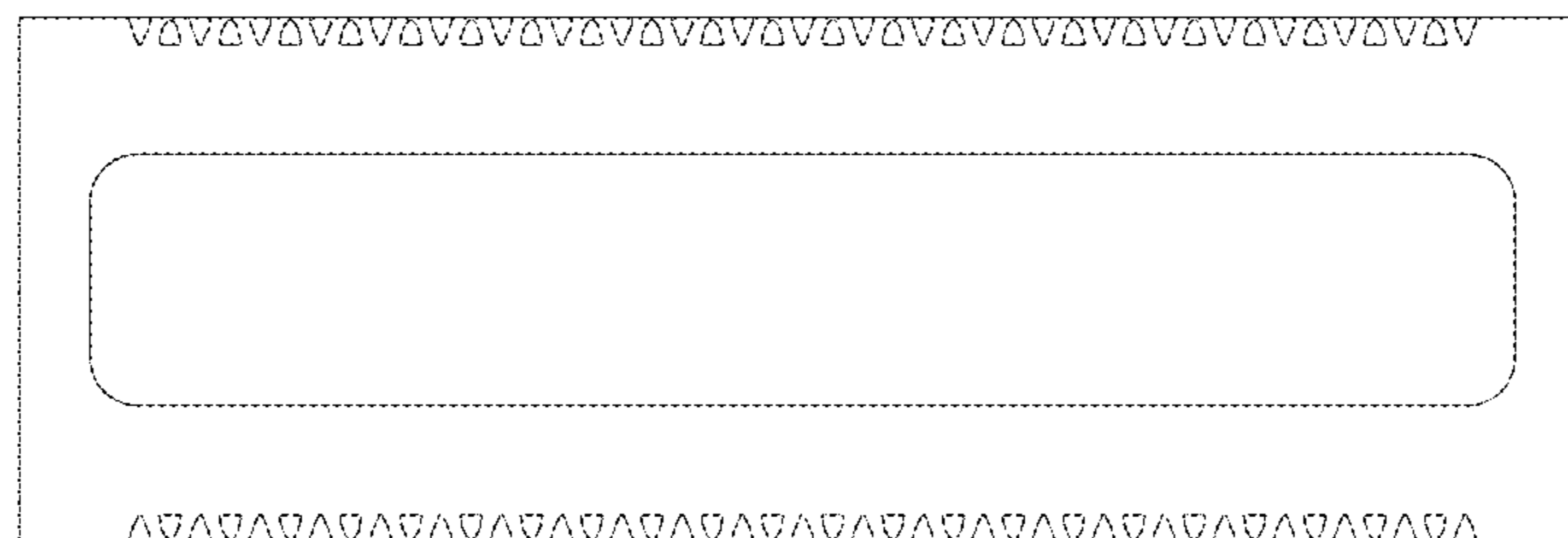

FIG.6

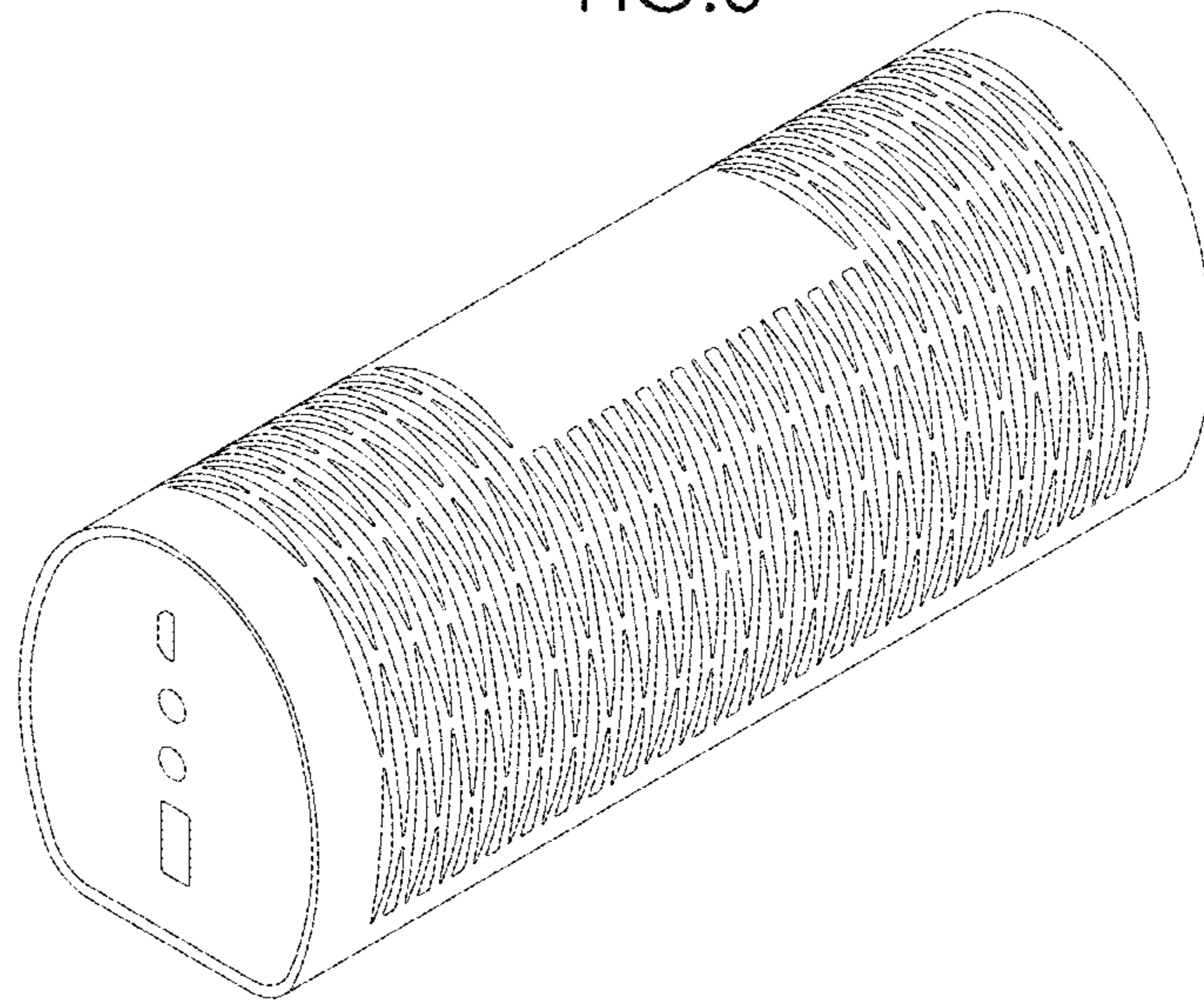

FIG.7

