



US00D737175S

(12) **United States Design Patent**
Telaak et al.

(10) **Patent No.:** **US D737,175 S**

(45) **Date of Patent:** **** *Aug. 25, 2015**

(54) **MOTOR VEHICLE, TOY REPLICA AND/OR
OTHER REPLICA**

(71) Applicant: **Audi AG**, Ingolstadt (DE)

(72) Inventors: **Gary Telaak**, Ingolstadt (DE); **Kamil
Labanowicz**, Ingolstadt (DE)

(73) Assignee: **AUDI AG**, Ingolstadt (DE)

(*) Notice: This patent is subject to a terminal disclaimer.

(**) Term: **14 Years**

(21) Appl. No.: **29/467,979**

(22) Filed: **Sep. 25, 2013**

(30) **Foreign Application Priority Data**

Mar. 26, 2013 (WO) DM/080 724

(51) **LOC (10) Cl.** **12-08**

(52) **U.S. Cl.**
USPC **D12/92; D21/548**

(58) **Field of Classification Search**
USPC D12/92, 86, 90, 91, 98, 88, 93;
D21/424, 433, 434, 533, 548, 549;
296/37.6, 181.1, 181.5, 183.1
See application file for complete search history.

(56) **References Cited**

U.S. PATENT DOCUMENTS

D601,924 S *	10/2009	Bauer et al.	D12/91
D634,243 S *	3/2011	Frei et al.	D12/91
D640,172 S *	6/2011	Furst	D12/90
D669,819 S *	10/2012	Hall et al.	D12/92
D684,900 S *	6/2013	Doyle et al.	D12/92
D685,293 S *	7/2013	Badstuebner et al.	D12/92
D687,739 S *	8/2013	Roura et al.	D12/91
D688,978 S *	9/2013	Badstuebner	D12/91
D698,281 S *	1/2014	Badstuebner et al.	D12/91

D700,107 S *	2/2014	Badstuebner et al.	D12/93
D700,108 S *	2/2014	Badstuebner et al.	D12/93
D705,129 S *	5/2014	Badstuebner et al.	D12/91
D706,174 S *	6/2014	Garand et al.	D12/92
D710,256 S *	8/2014	Garand	D12/91
D711,779 S *	8/2014	Badstuebner et al.	D12/91
D711,780 S *	8/2014	Badstuebner et al.	D12/91
D711,781 S *	8/2014	Badstuebner et al.	D12/91
D711,782 S *	8/2014	Witowski	D12/91
D711,783 S *	8/2014	Badstuebner	D12/91

OTHER PUBLICATIONS

Commonly assigned, Co-pending Design U.S. Appl. No. 29/458,009, filed Jun. 14, 2013.

* cited by examiner

Primary Examiner — Cathron Brooks

Assistant Examiner — Clese Moore, Jr.

(74) *Attorney, Agent, or Firm* — Abelman, Frayne & Schwab

(57) **CLAIM**

The ornamental design for motor vehicle, toy replica or replica, as shown and described.

DESCRIPTION

FIG. 1 is a front and left side perspective view of the motor vehicle, toy replica or replica, showing our new design; FIG. 2 is a rear and left side perspective view of the motor vehicle, toy replica or replica, of FIG. 1; FIG. 3 is a right side elevation view thereof; FIG. 4 is a left side elevation view thereof; FIG. 5 is a top plan view thereof; FIG. 6 is a rear elevation view thereof; and, FIG. 7 is a front elevation view thereof.

The uniform broken lines shown in the drawings illustrate portions of the motor vehicle, toy replica or replica that form no part of the claimed design. The dash-dot broken lines illustrate boundaries between claimed and unclaimed surfaces and form no part of the claimed design.

1 Claim, 5 Drawing Sheets

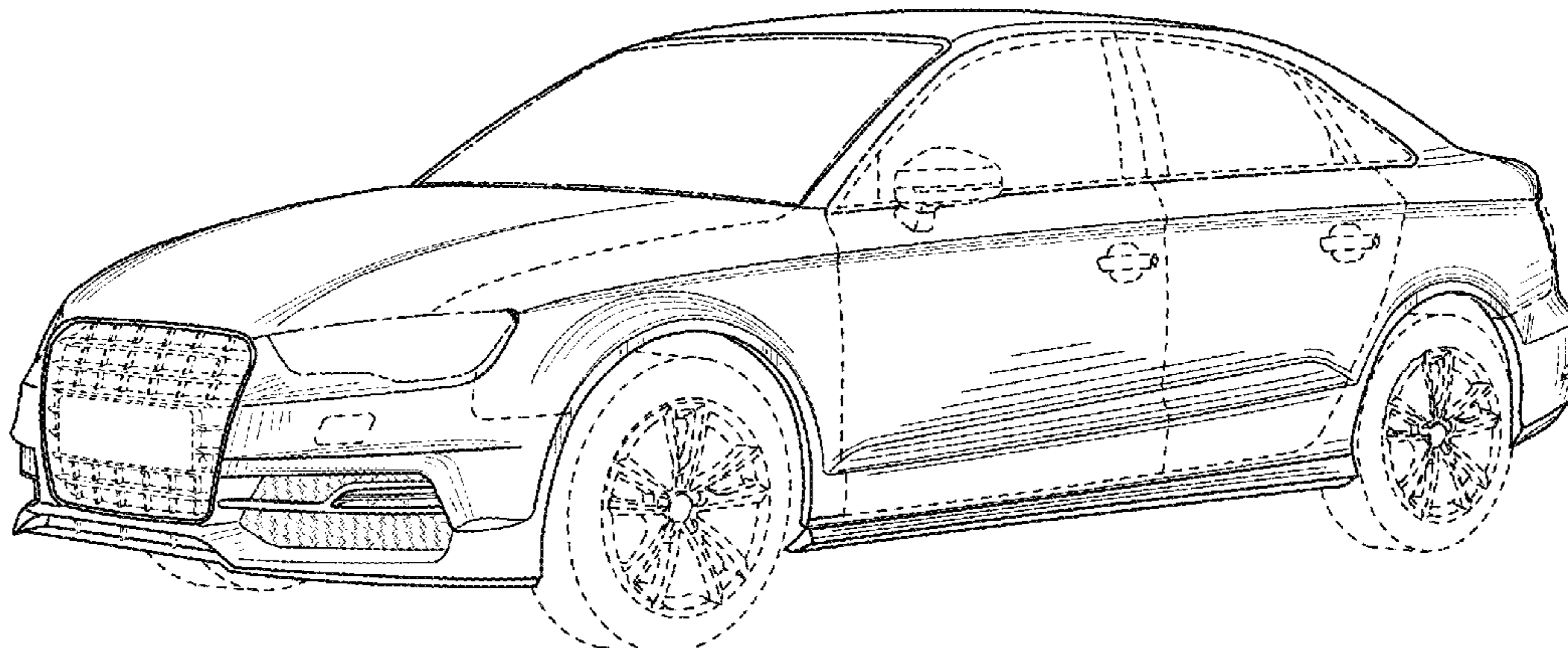

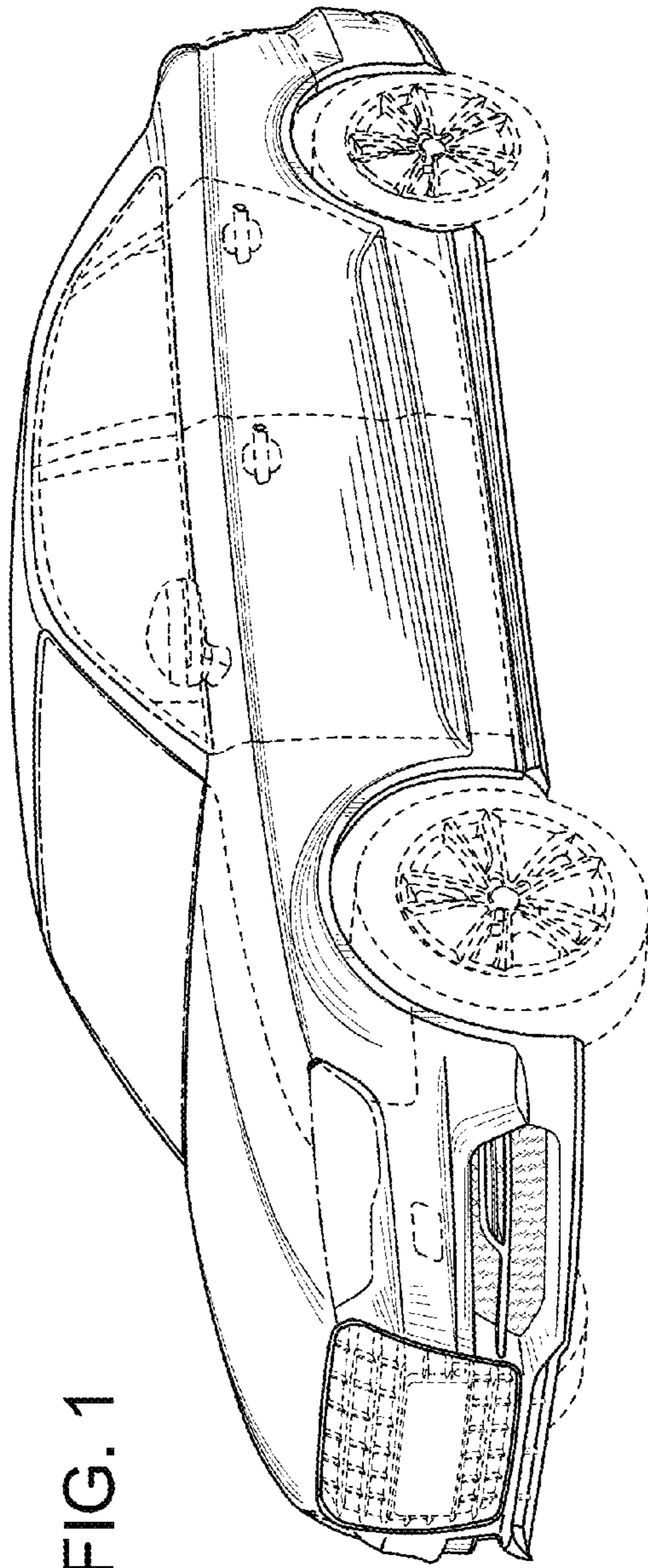

FIG. 1

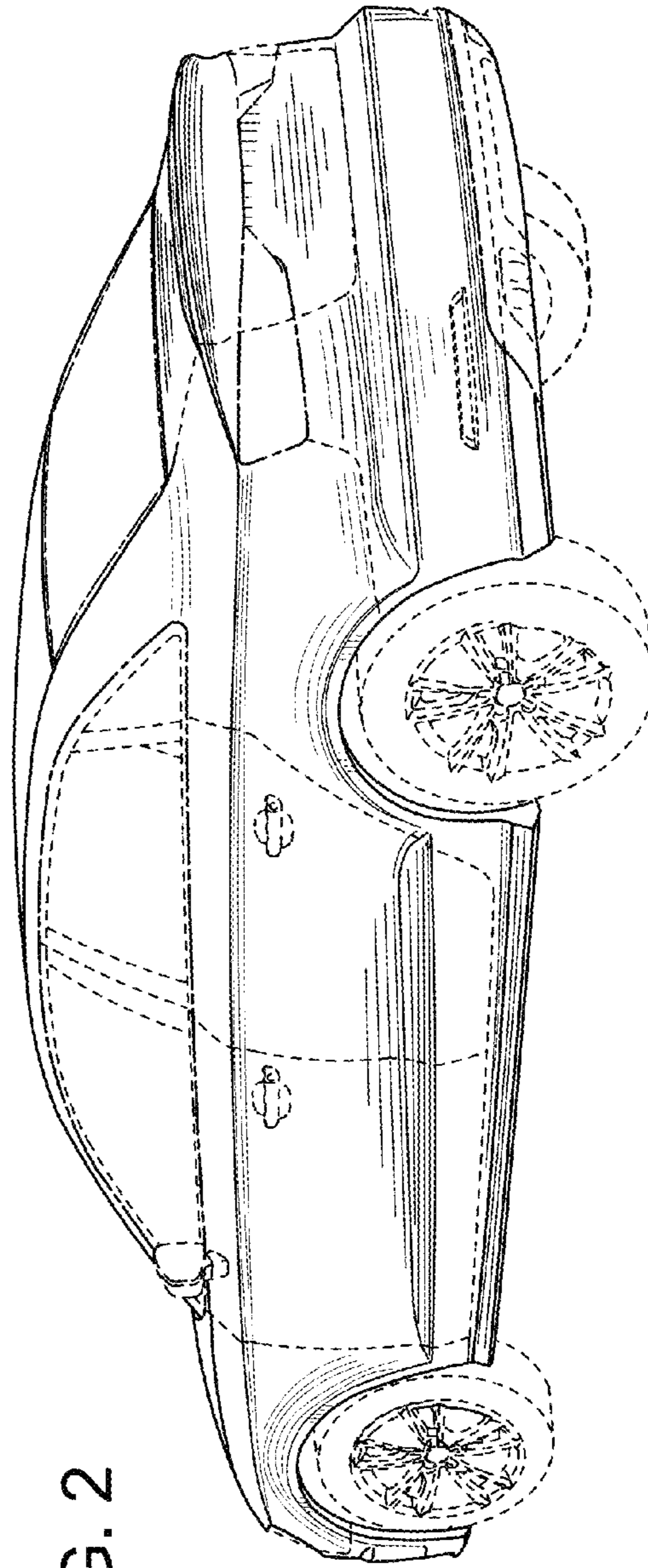

FIG. 2

FIG. 3

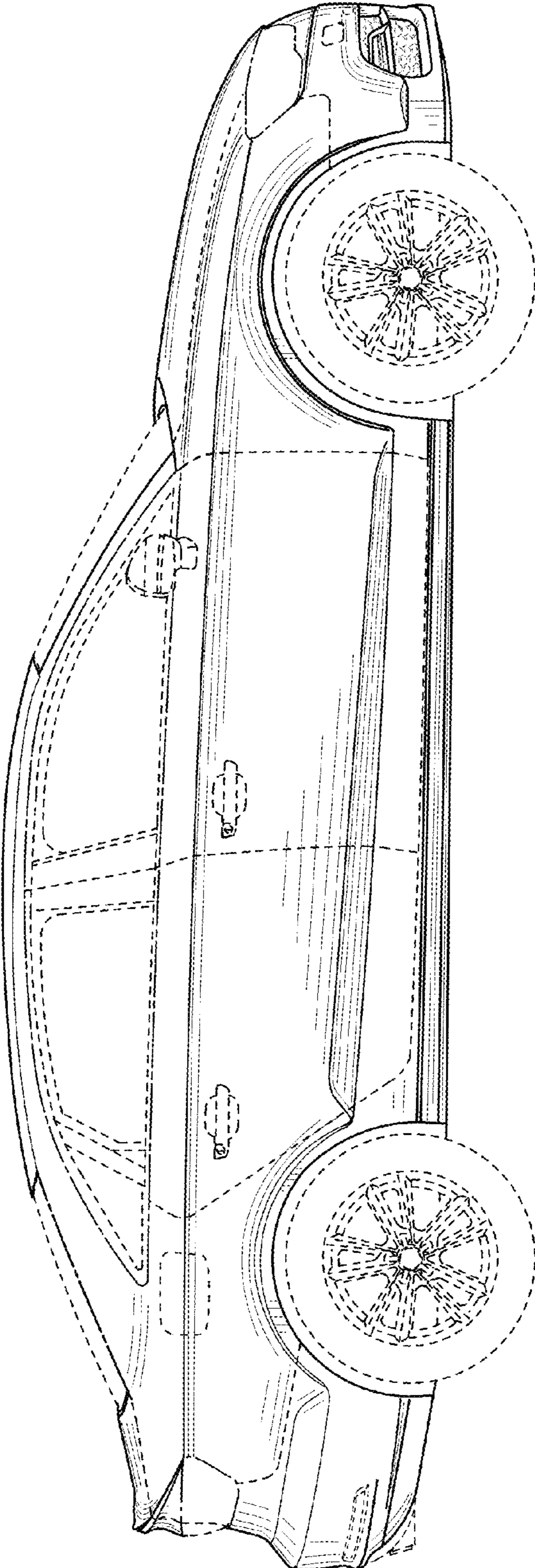
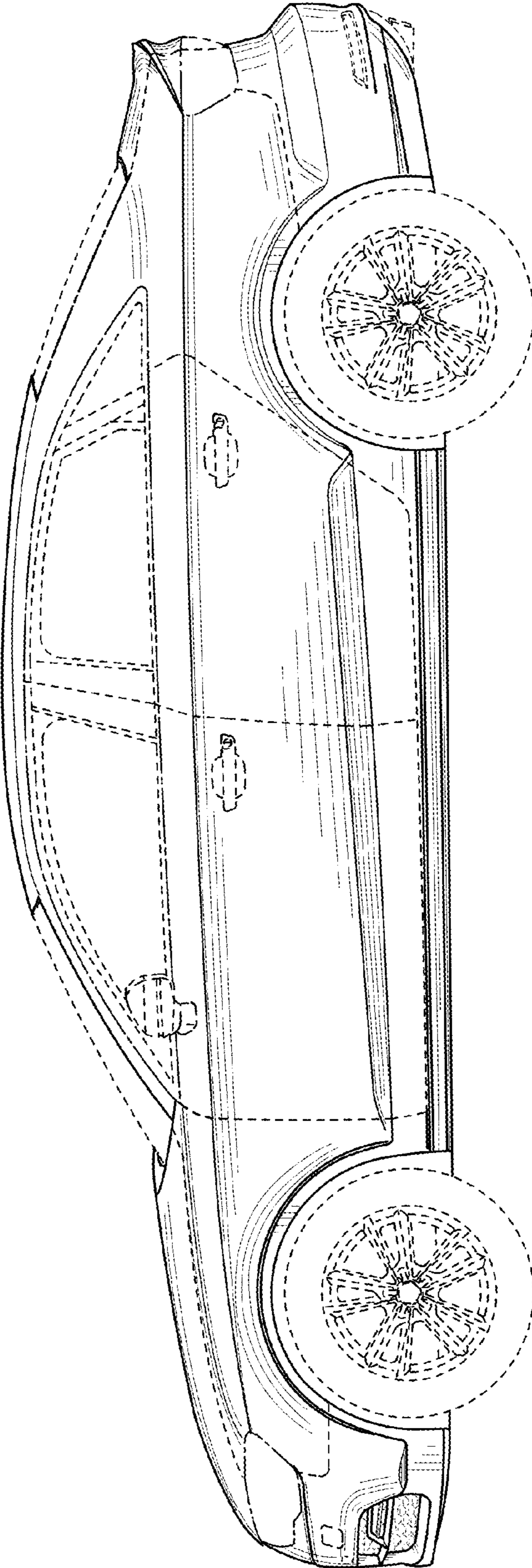

FIG. 4



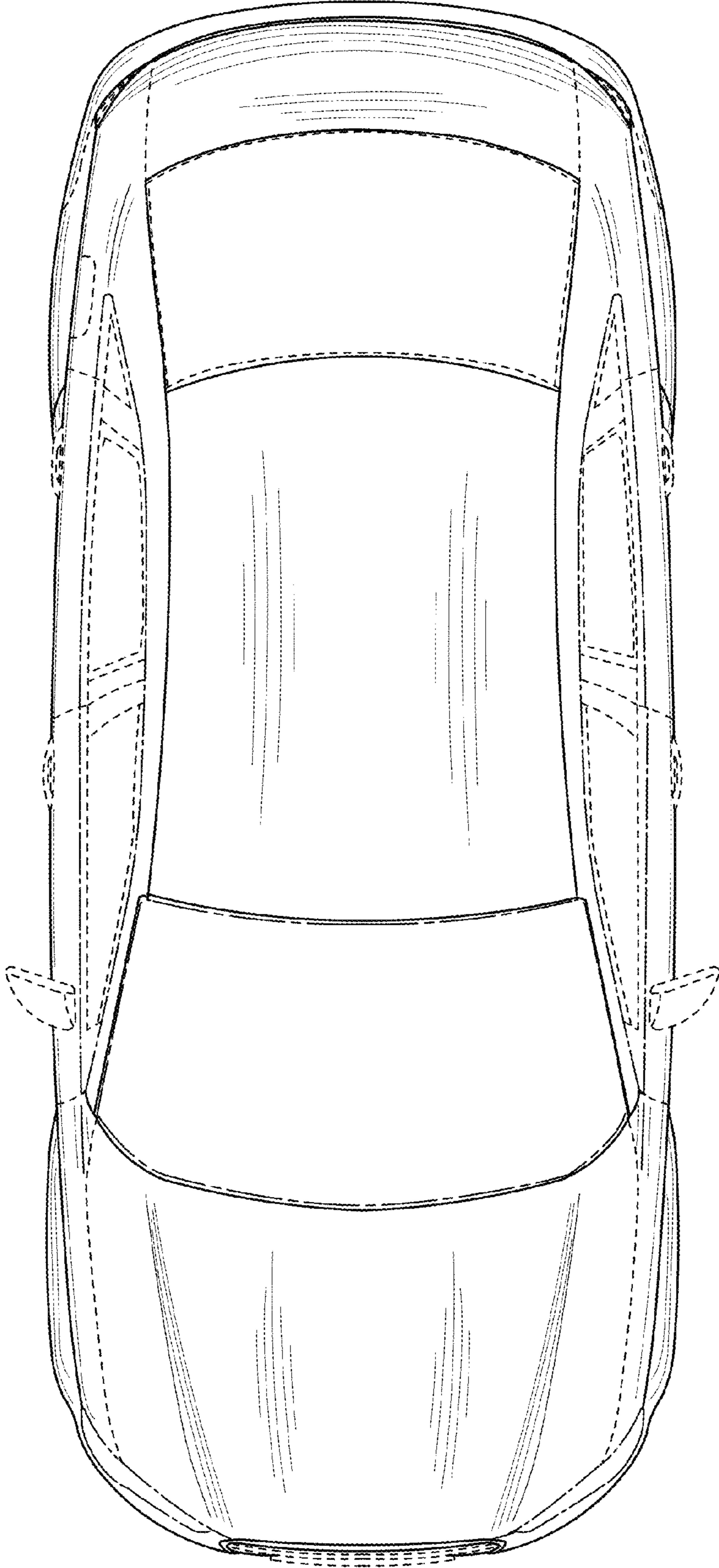

FIG. 5

FIG. 6

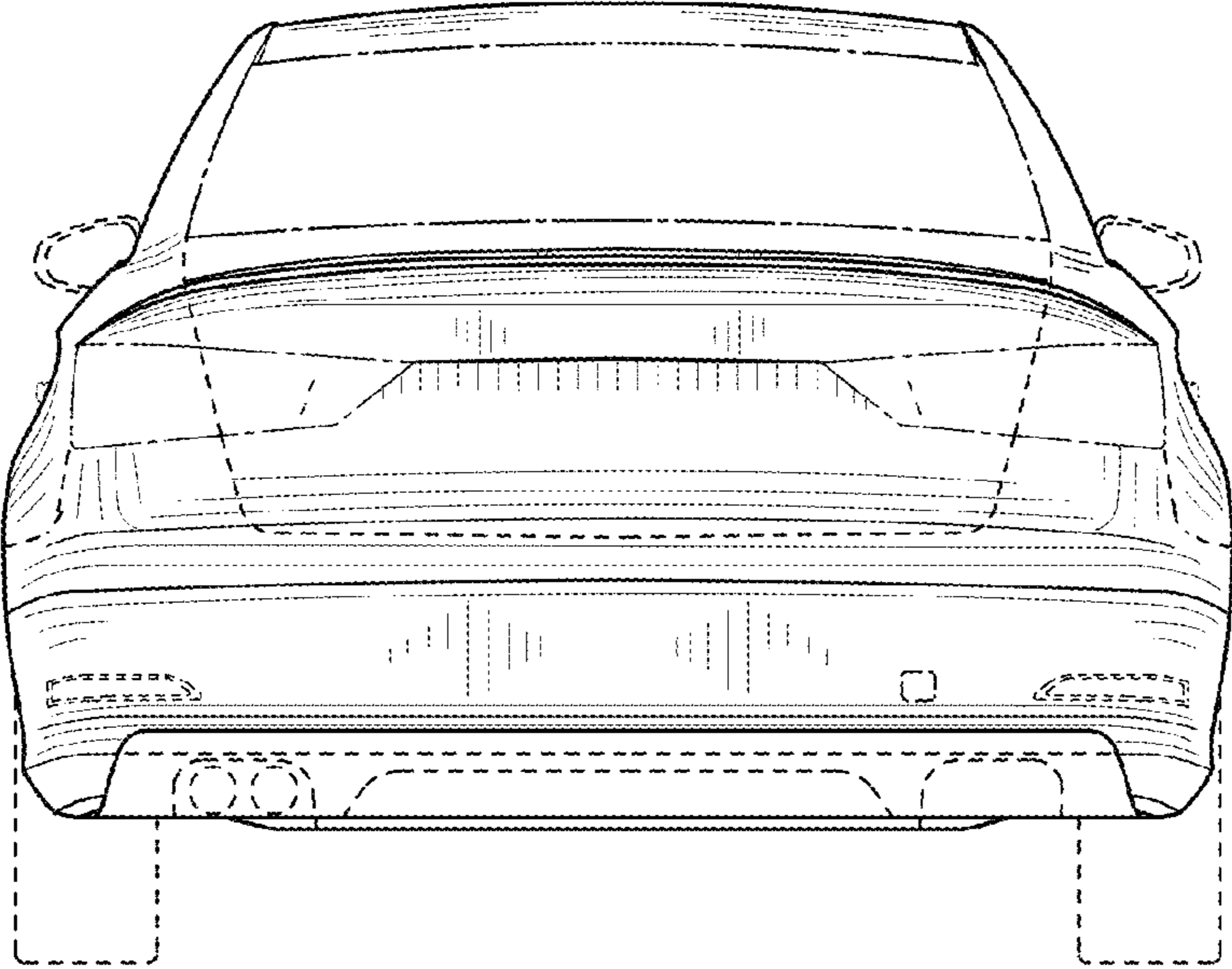

FIG. 7

