



US00D737153S

(12) **United States Design Patent**
Lombard et al.

(10) **Patent No.:** **US D737,153 S**
(45) **Date of Patent:** **** Aug. 25, 2015**

(54) **THERMOSTAT DEVICE WITH LOW PROFILE TRIM PLATE**

11/001; F24F 2011/0057; F24F 2011/0073;
F24F 2011/0091

See application file for complete search history.

(71) Applicant: **ecobee, Inc.**, Toronto (CA)

(56) **References Cited**

(72) Inventors: **Stuart Lombard**, Toronto (CA); **Mark Malchiondo**, Mississauga (CA); **Nashib Qadri**, Toronto (CA); **Hesham Fahmy**, Mississauga (CA); **Mary Richardson**, Toronto (CA); **Christina Tiffin**, Toronto (CA); **Marcelle Van Beusekom**, San Francisco, CA (US); **Jonathan Mendoza**, San Francisco, CA (US); **Jeffrey Allen Salazar**, Palo Alto, CA (US); **Wenson Chern**, Mountain View, CA (US)

U.S. PATENT DOCUMENTS

7,726,581 B2 * 6/2010 Naujok et al. 236/1 C
D703,071 S * 4/2014 Arnett D10/60

Primary Examiner — Antoine D Davis

(74) *Attorney, Agent, or Firm* — Perry + Currier Inc.

(73) Assignee: **ecobee, Inc.**, Toronto (CA)

(57) **CLAIM**

The ornamental design for a thermostat device with low profile trim plate, as shown and described in the Figures.

(**) Term: **14 Years**

DESCRIPTION

(21) Appl. No.: **29/470,526**

(22) Filed: **Oct. 22, 2013**

(51) **LOC (10) Cl.** **10-04**

(52) **U.S. Cl.**
USPC **D10/50**

(58) **Field of Classification Search**
USPC D10/49–50, 103; D13/162; 55/279, 55/DIG. 7; 62/176.6, 125–130, 78, 180, 62/186; 73/23.2, 23.34, 31.01, 31.02, 431, 73/170.16–170.19, 170.21–170.25, 73/863.12, 29.02, 335.01–335.14; 220/3.2; 236/46 R, 47, 94, 44 C, 44 R, 236/49.3, 44 A, 96, 1 B, 1 C, 1 E, 1 EA, 1 EB, 236/1 F, 1 G, 1 H, 9 R; 337/112, 327, 360; 340/602, 627, 632, 634; 349/56–72; 454/229, 239, 256, 257, 258; 700/18, 700/159, 181, 276, 277, 278
CPC F23N 5/20; F23N 5/203; F23N 5/206; F23N 5/18; F23N 5/184; F23N 5/187; F23N 5/22; F23N 2025/12; F23N 2041/02; F24F 11/00; F24F 11/0012; F24F 11/0009; F24F

FIG. 1 is a perspective view of a thermostat device with a trim plate showing a new design for a thermostat device with a trim plate;
FIG. 2 is a front plan view thereof;
FIG. 3a is a top plan view thereof;
FIG. 3b is a bottom plan view thereof;
FIG. 4a is a side plan view thereof;
FIG. 4b is another side plan view thereof;
FIG. 5 is an exploded view of the thermostat and trim plate shown in FIG. 1;
FIG. 6 is a front plan view of the trim plate shown in FIG. 5;
FIG. 7 is a side plan view of the trim plate shown in FIG. 5;
FIG. 8 is a front plan of the thermostat shown in FIG. 5;
FIGS. 9a and 9b are side plan views of the thermostat shown in FIG. 5;
FIG. 10a is a top plan view of the thermostat shown in FIG. 5;
and,
FIG. 10b is a bottom plan view of the thermostat shown in FIG. 5.

1 Claim, 8 Drawing Sheets

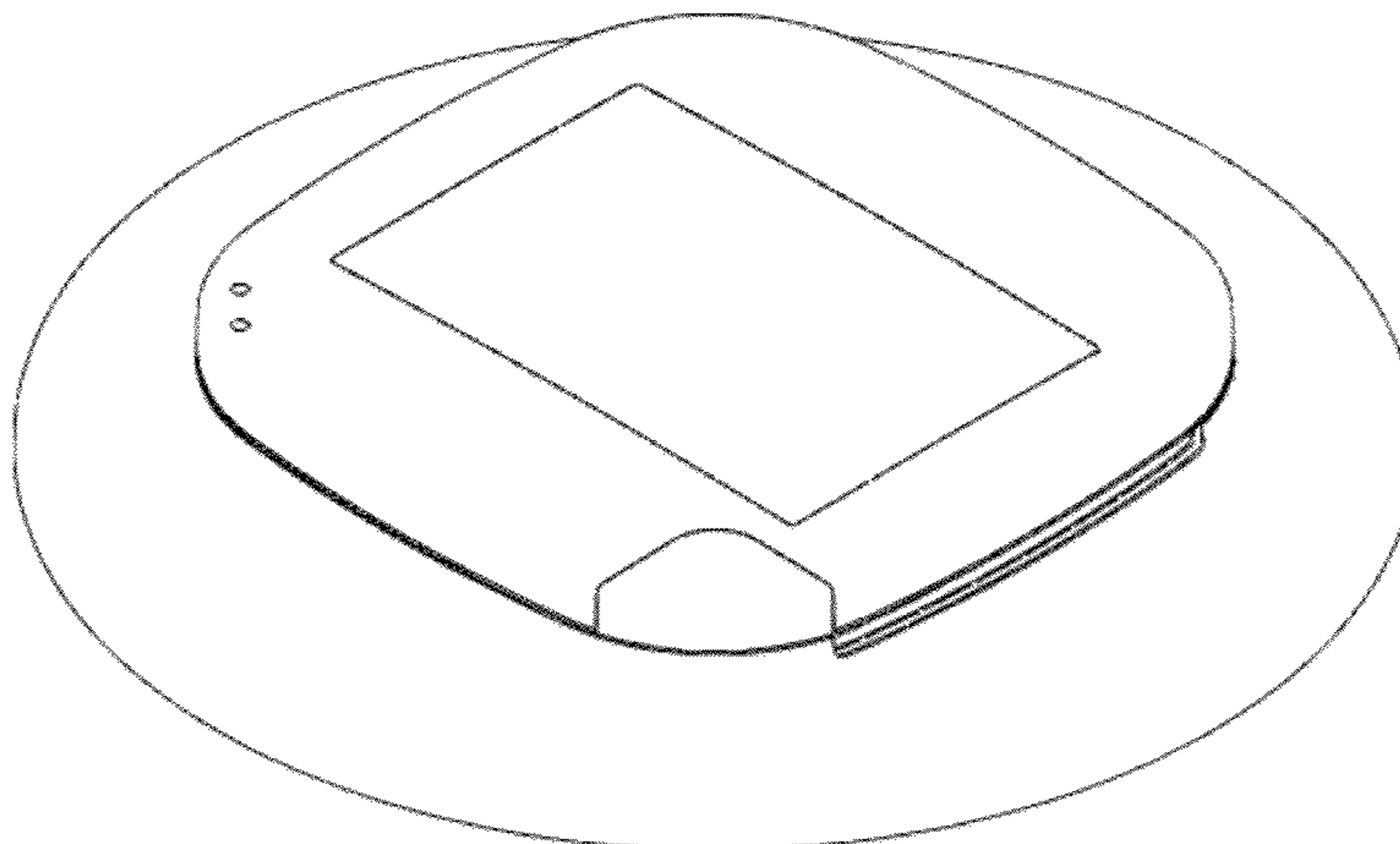

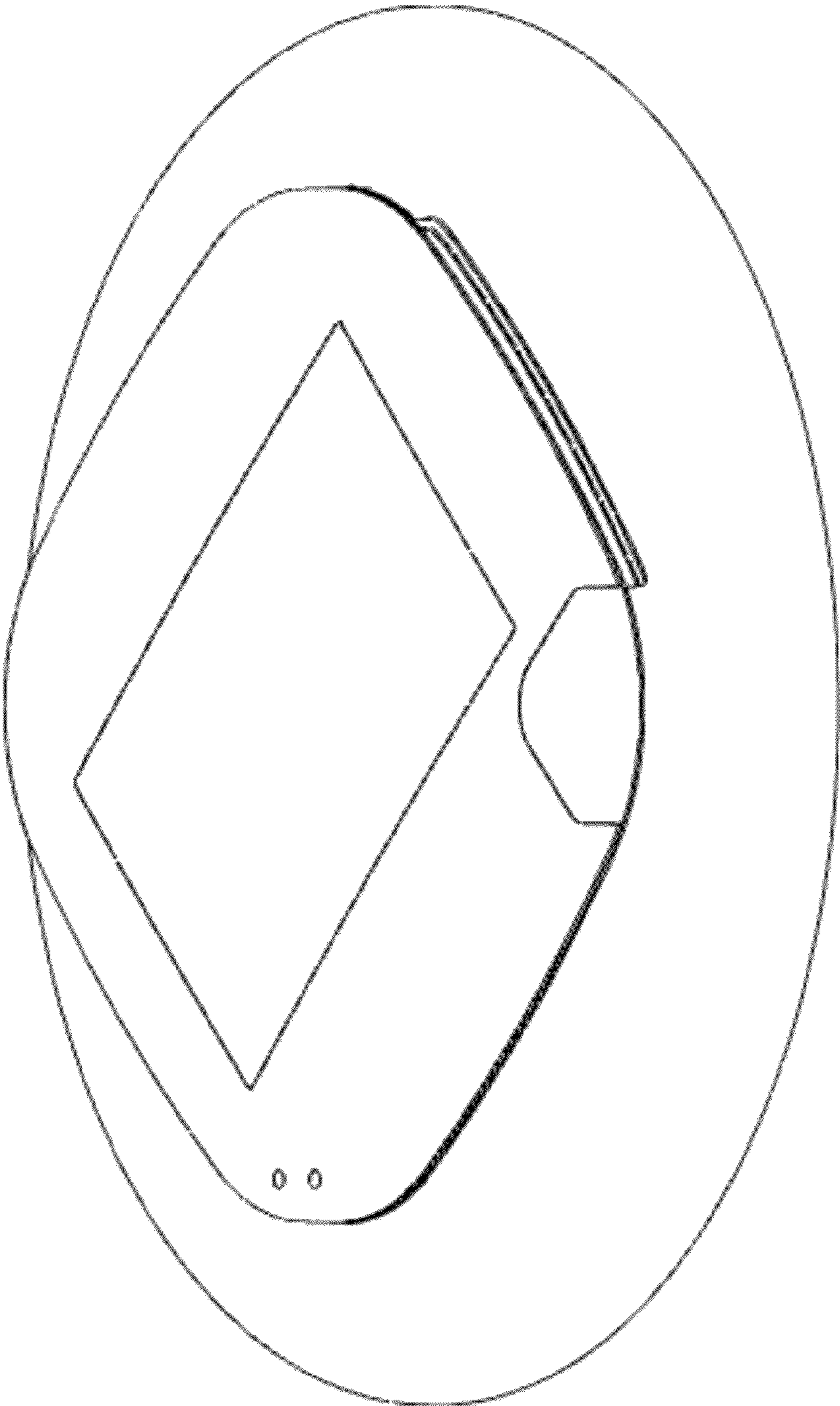
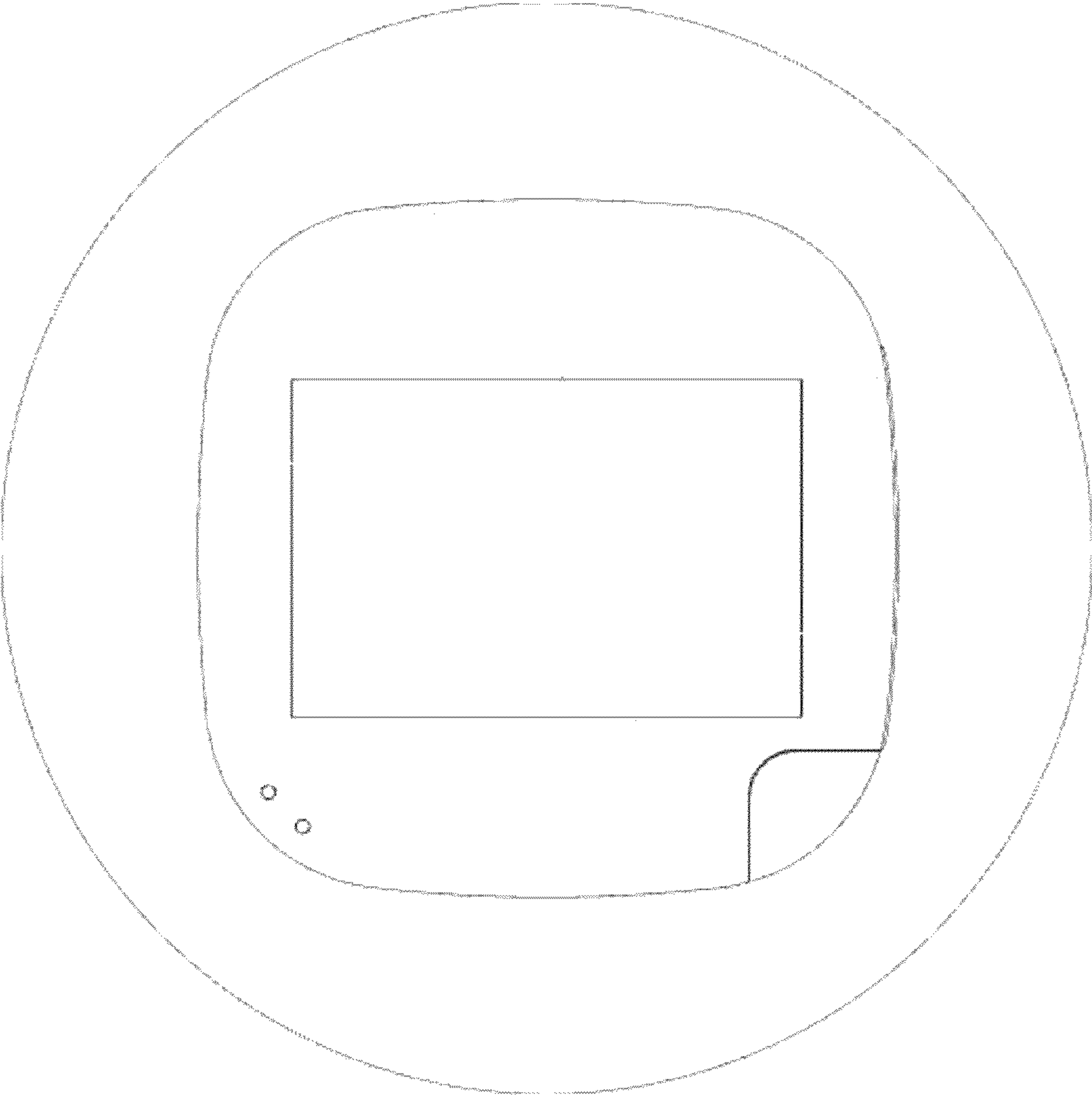

Fig. 1

Fig. 2



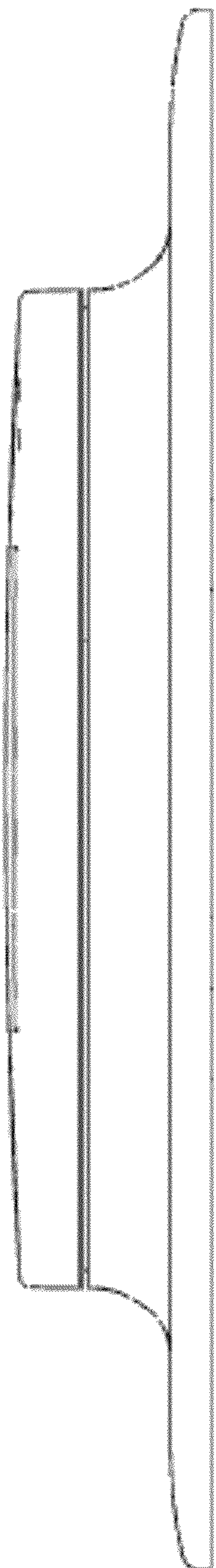

Fig. 3a

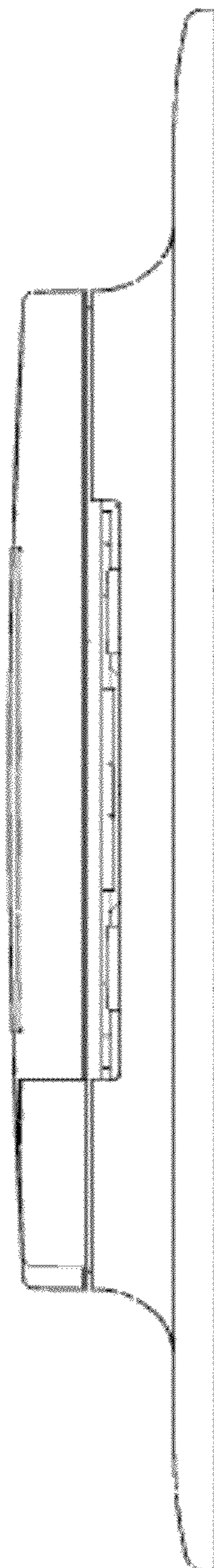

Fig. 3b

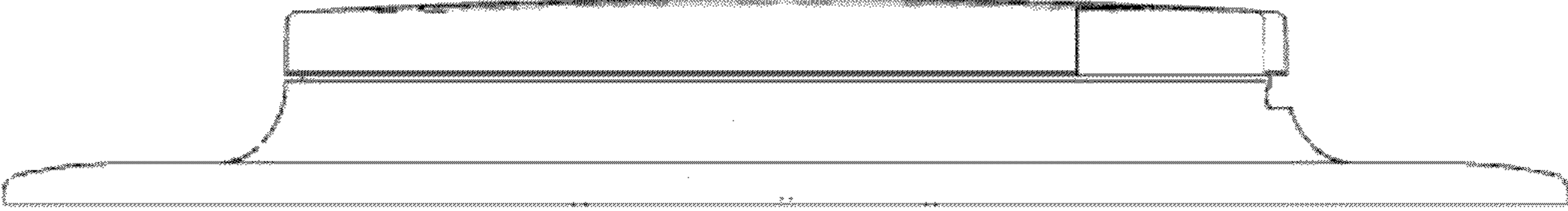

Fig. 4b

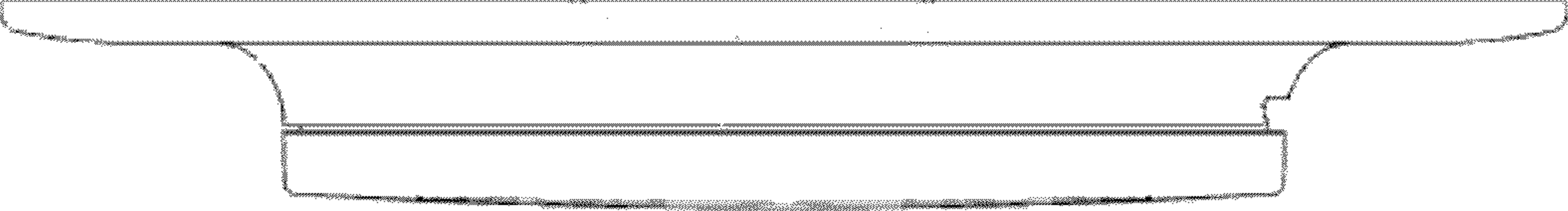

Fig. 4a

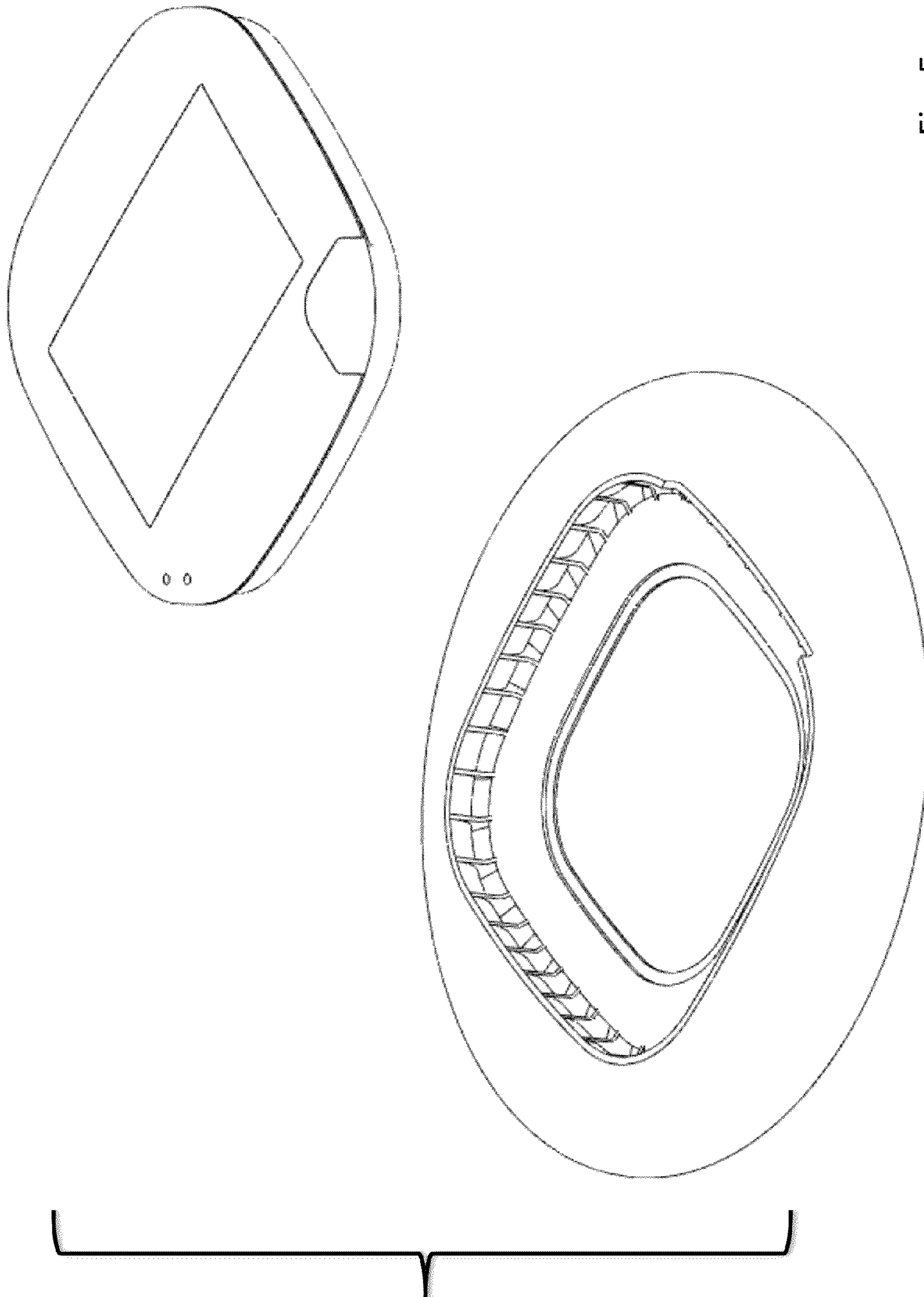

Fig. 5



Fig. 7

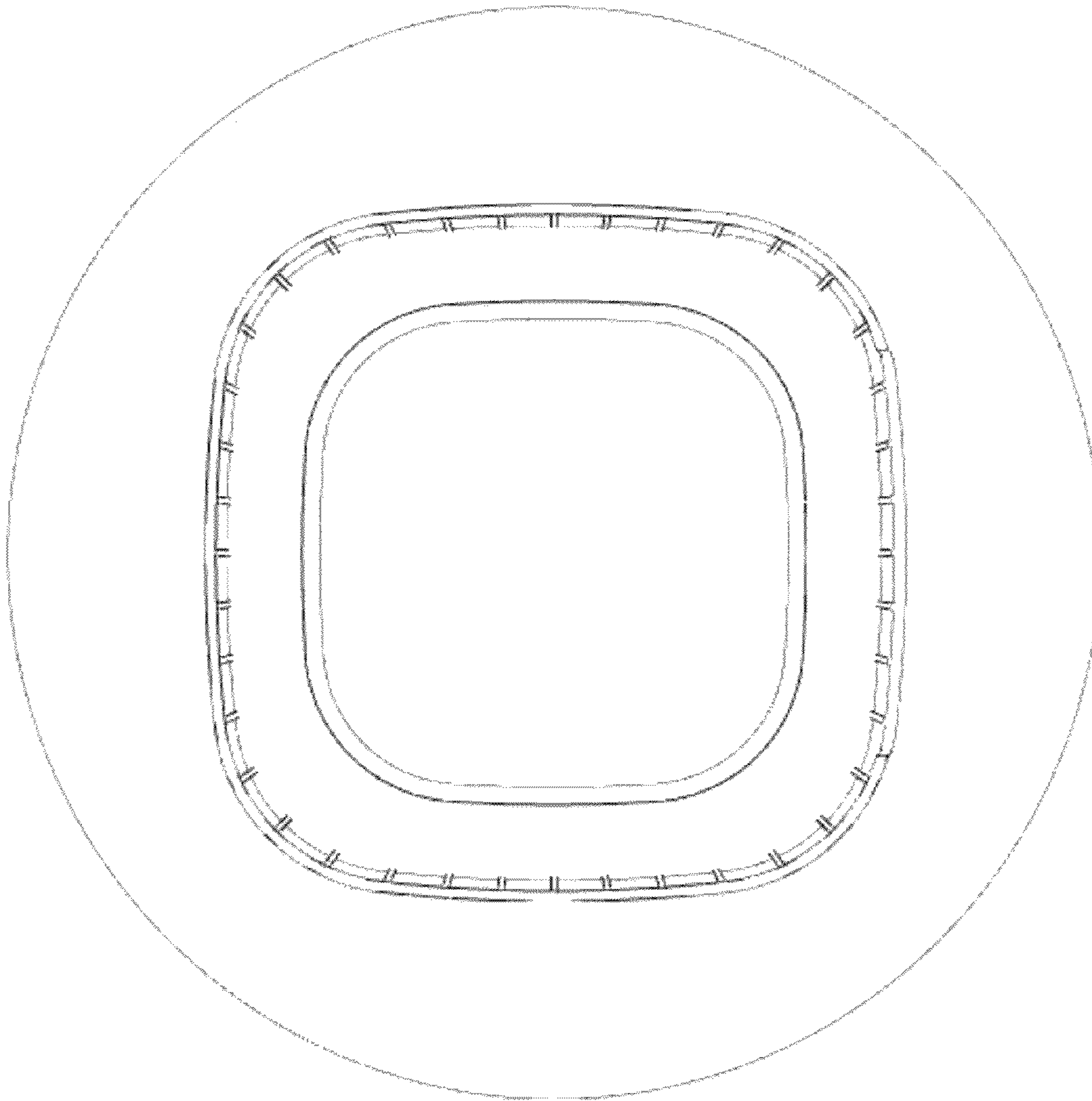

Fig. 6

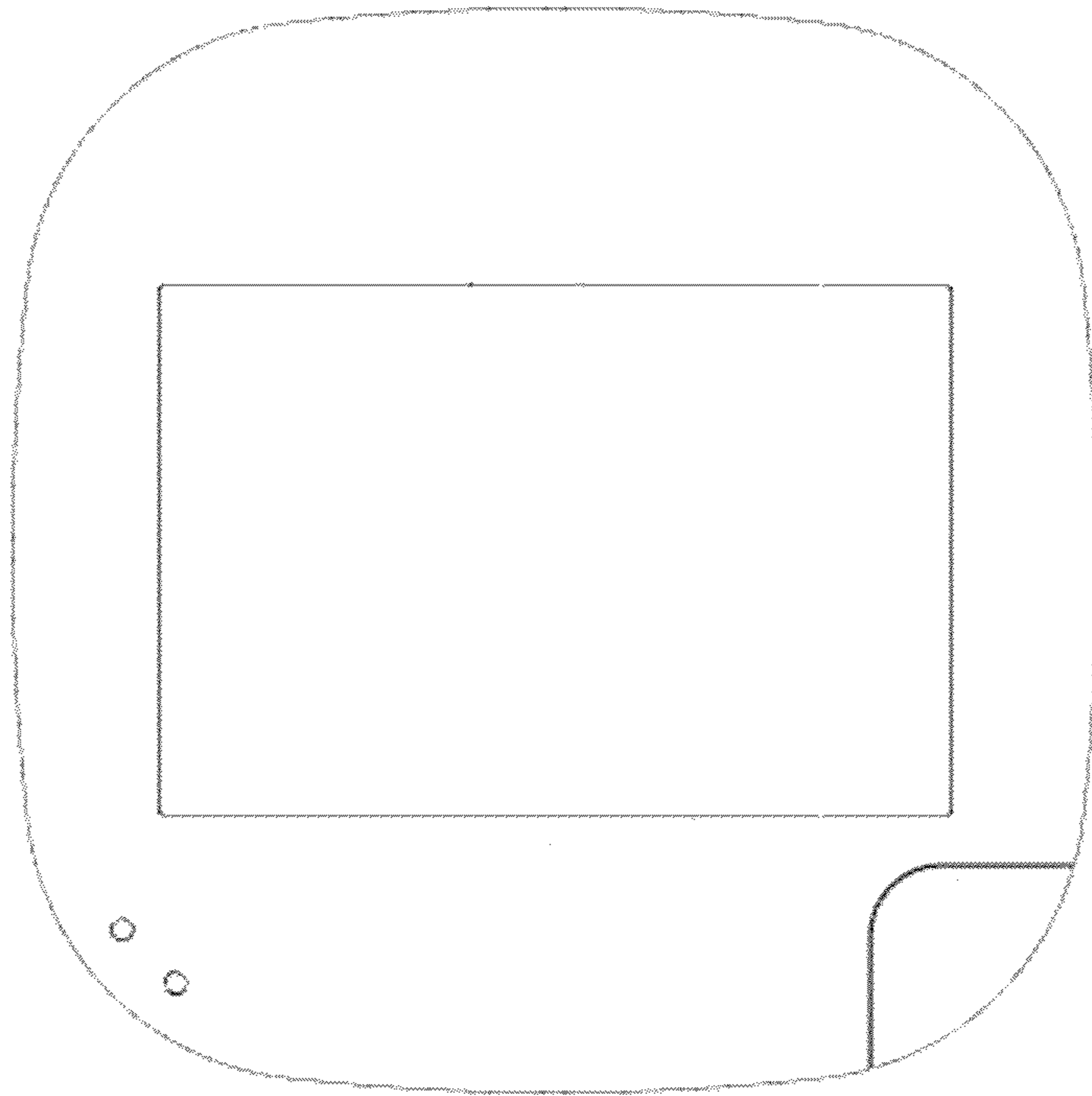

Fig. 8



Fig. 9a



Fig. 9b

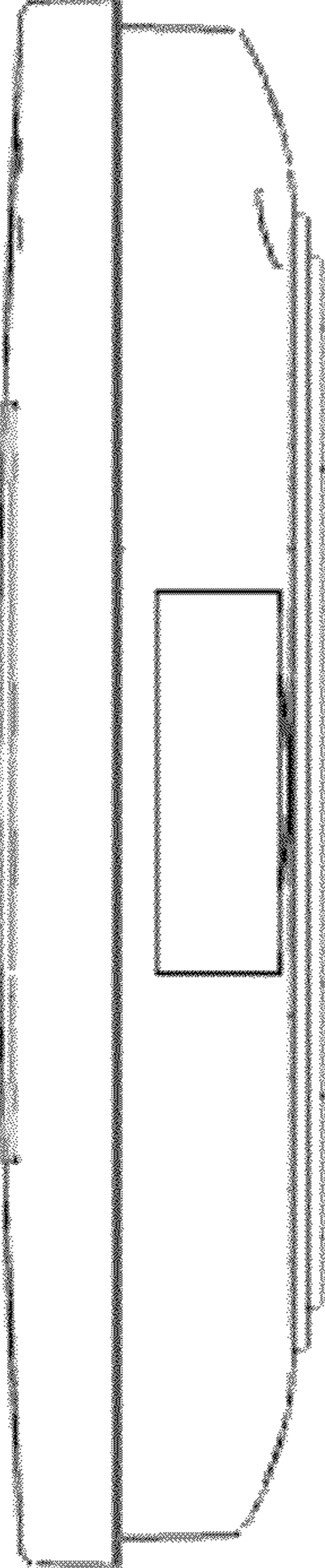

Fig. 10a

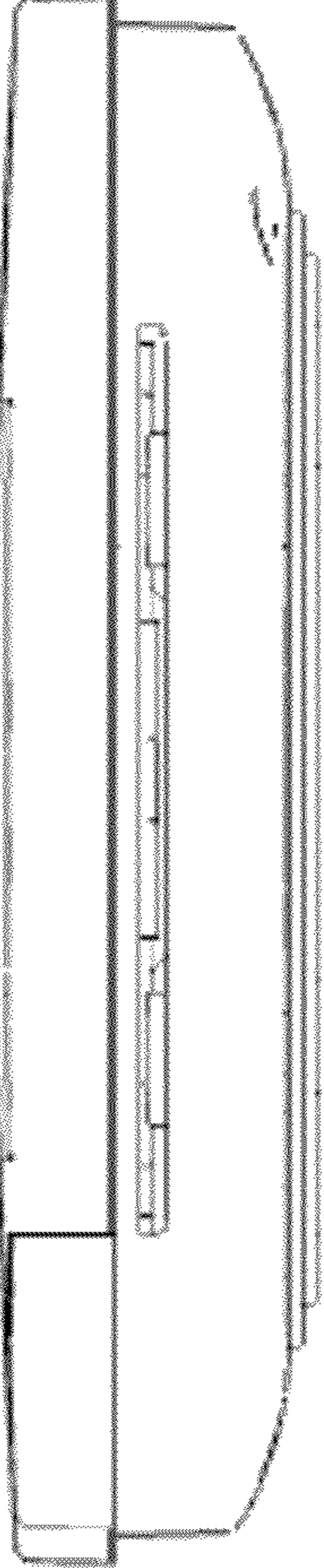

Fig. 10b