



US00D737149S

(12) **United States Design Patent**
Son

(10) **Patent No.:** **US D737,149 S**

(45) **Date of Patent:** **** Aug. 25, 2015**

(54) **COSMETIC CONTAINER**

(71) Applicant: **AMOREPACIFIC CORPORATION,**
Seoul (KR)

(72) Inventor: **Sung Eun Son,** Seoul (KR)

(73) Assignee: **AMOREPACIFIC CORPORATION,**
Yongsan-Gu, Seoul (KR)

(**) Term: **14 Years**

(21) Appl. No.: **29/486,680**

(22) Filed: **Apr. 1, 2014**

(51) **LOC (10) Cl.** **09-01**

(52) **U.S. Cl.**
USPC **D9/688**

(58) **Field of Classification Search**

USPC D9/682-694, 504, 516, 529, 434-436,
D9/445, 448; D28/76, 77, 88, 89, 91.1;
222/153.11-153.14, 631, 635,
222/321.1-321.5, 321.6-322, 372, 373,
222/379, 383.3, 383.1, 386, 389, 398,
222/400.5-401, 402-402.25

CPC B05B 11/00; B05B 11/0027; B05B 11/0035;
B05B 11/3004; B05B 11/3001; B65D 83/14

See application file for complete search history.

(56) **References Cited**

U.S. PATENT DOCUMENTS

D279,511 S * 7/1985 Matsubara et al. D28/91.1
D306,137 S * 2/1990 Nitta D9/686
D406,761 S * 3/1999 Garcia D9/434
D422,902 S * 4/2000 Kikuchi D9/689
D472,152 S * 3/2003 Joubert D9/529
6,648,244 B2 * 11/2003 Yu 239/323
D565,952 S * 4/2008 Mettler et al. D9/504
D570,707 S * 6/2008 Blasko et al. D9/689
D583,678 S * 12/2008 Yamamoto D9/692
D639,166 S * 6/2011 Carreno D9/504
D651,918 S * 1/2012 Daniels et al. D9/691

D682,709 S * 5/2013 Wang D9/691
D683,238 S * 5/2013 You D9/688
D688,138 S * 8/2013 Kim D9/690
D692,773 S * 11/2013 Kim D9/690
D703,053 S * 4/2014 Park D9/503
2009/0224001 A1 * 9/2009 Suzuki 222/153.06
2012/0267390 A1 * 10/2012 Jeong et al. 222/41
2013/0228482 A1 * 9/2013 Son 206/219
2014/0117051 A1 * 5/2014 Duquet 222/148

FOREIGN PATENT DOCUMENTS

JP 300542293.0000 * 10/2009
JP 300552959.0000 * 2/2010
JP D1389336 * 6/2010
KR 300496257.0000 * 6/2008
KR 300558121.0000 * 4/2010
KR 300542293.0001 * 11/2011
KR 300621067.0000 * 11/2011
KR 300621067.0001 * 12/2011

* cited by examiner

Primary Examiner — Catherine Tuttle

(74) *Attorney, Agent, or Firm* — East West Law Group;
Heedong Chae

(57) **CLAIM**

The ornamental design for a cosmetic container, as shown and described.

DESCRIPTION

FIG. 1 is a perspective view of a cosmetic container showing my new design;

FIG. 2 is a front elevational view thereof;

FIG. 3 is a rear elevational view thereof;

FIG. 4 is a left side elevational view thereof;

FIG. 5 is a right side elevational view thereof;

FIG. 6 is a top plan view thereof; and,

FIG. 7 is an exploded view thereof.

The broken line showing of environment is for illustrative purposes only and forms no part of the claimed design.

1 Claim, 7 Drawing Sheets

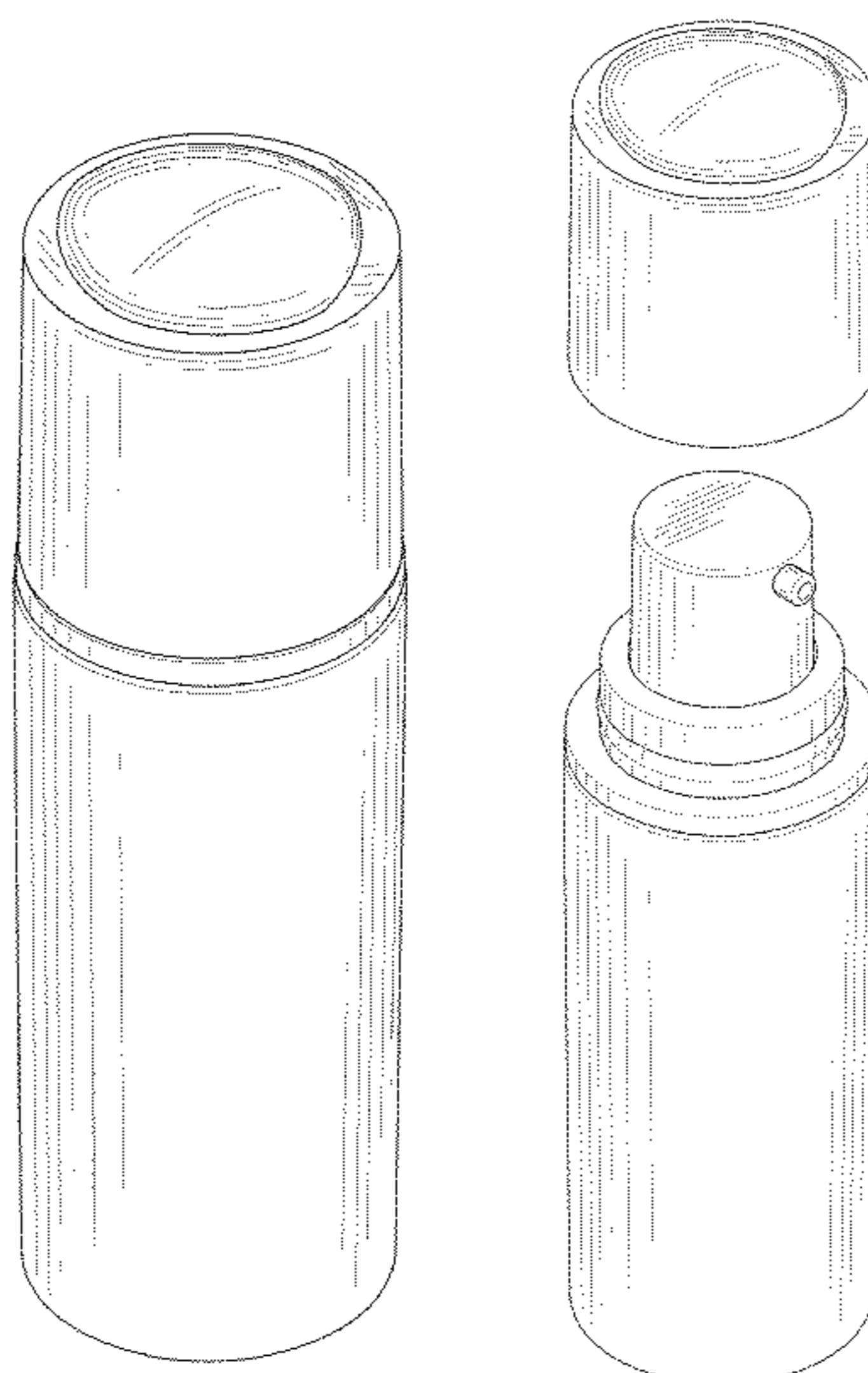

FIG. 1

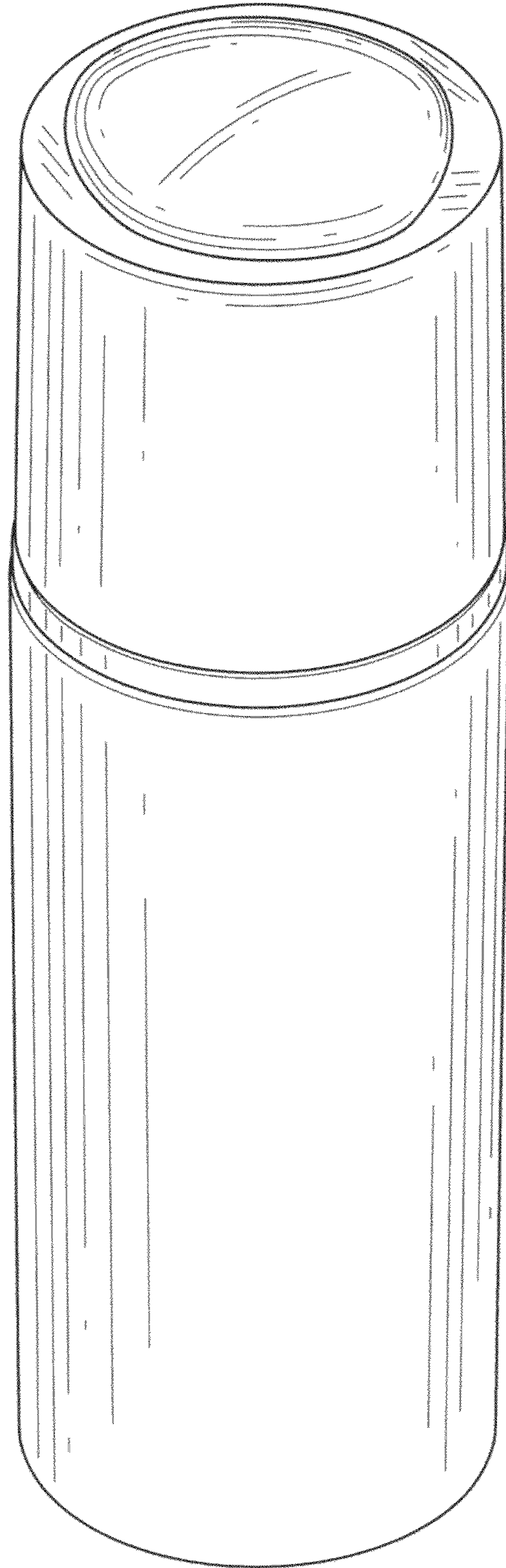

FIG. 2

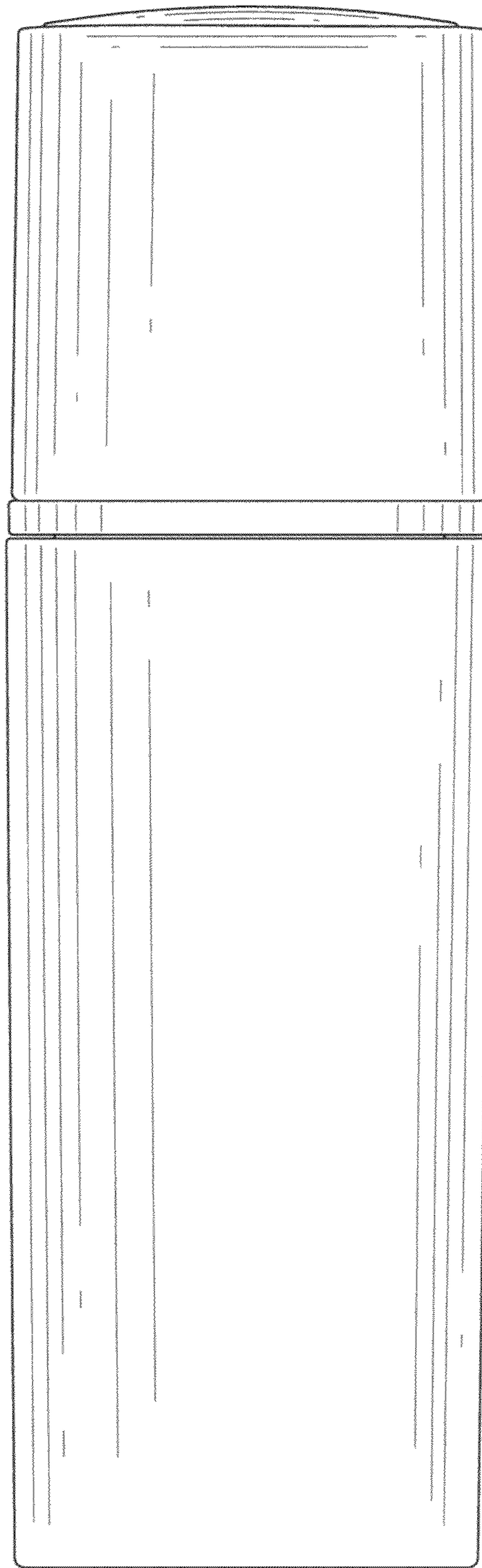

FIG. 3

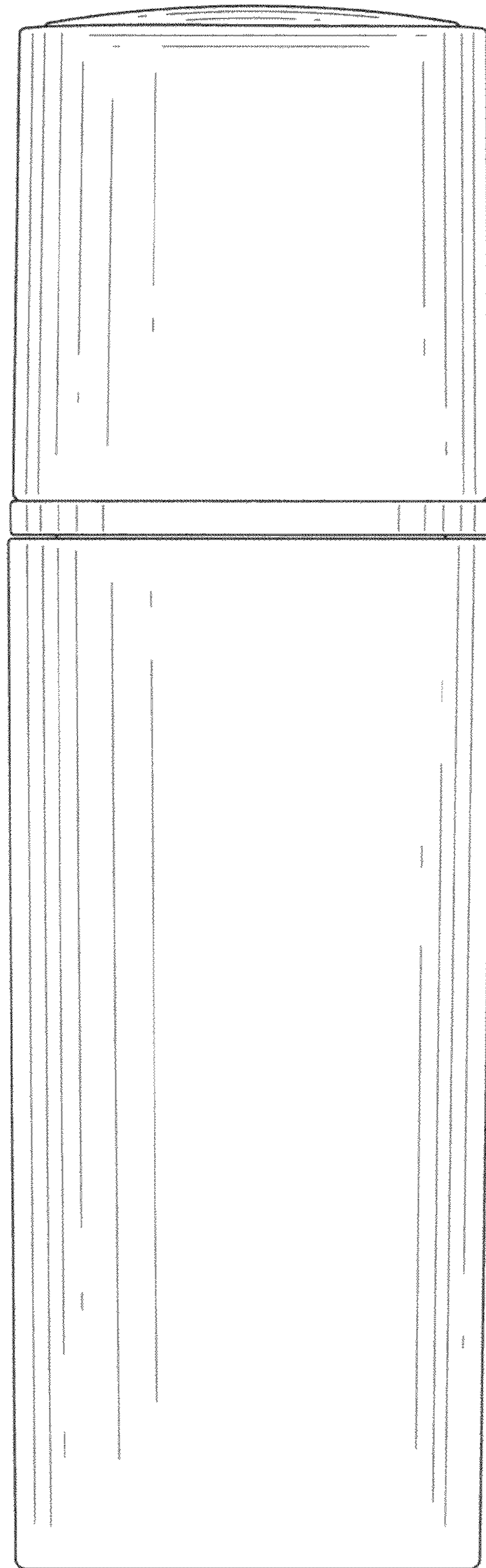

FIG. 4

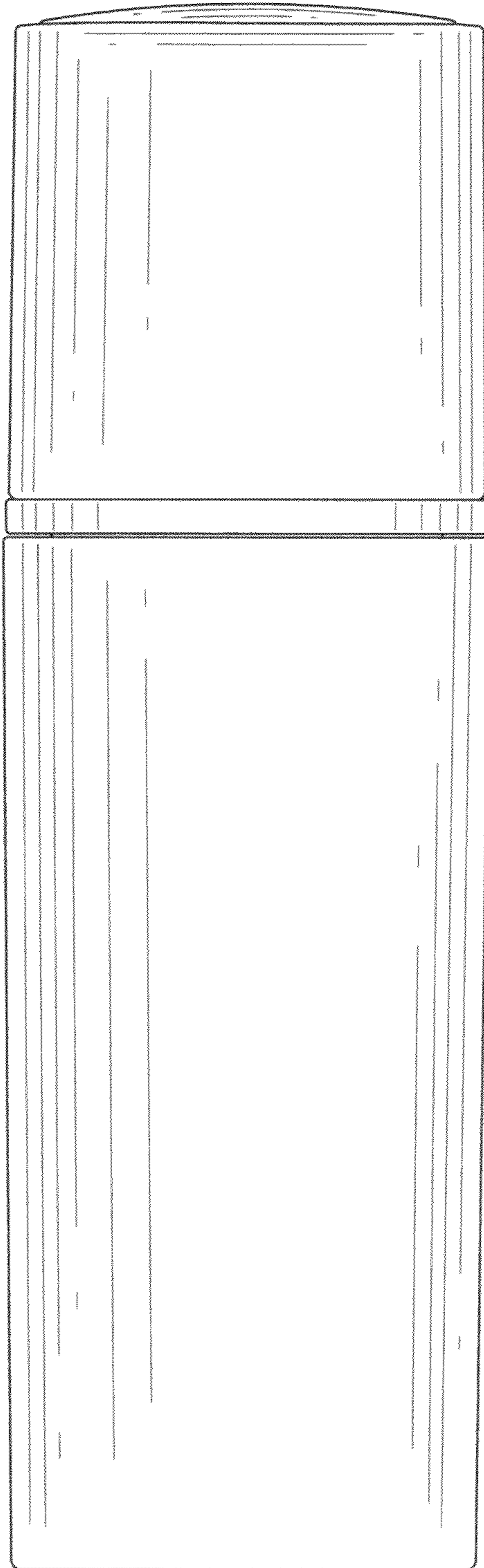

FIG. 5

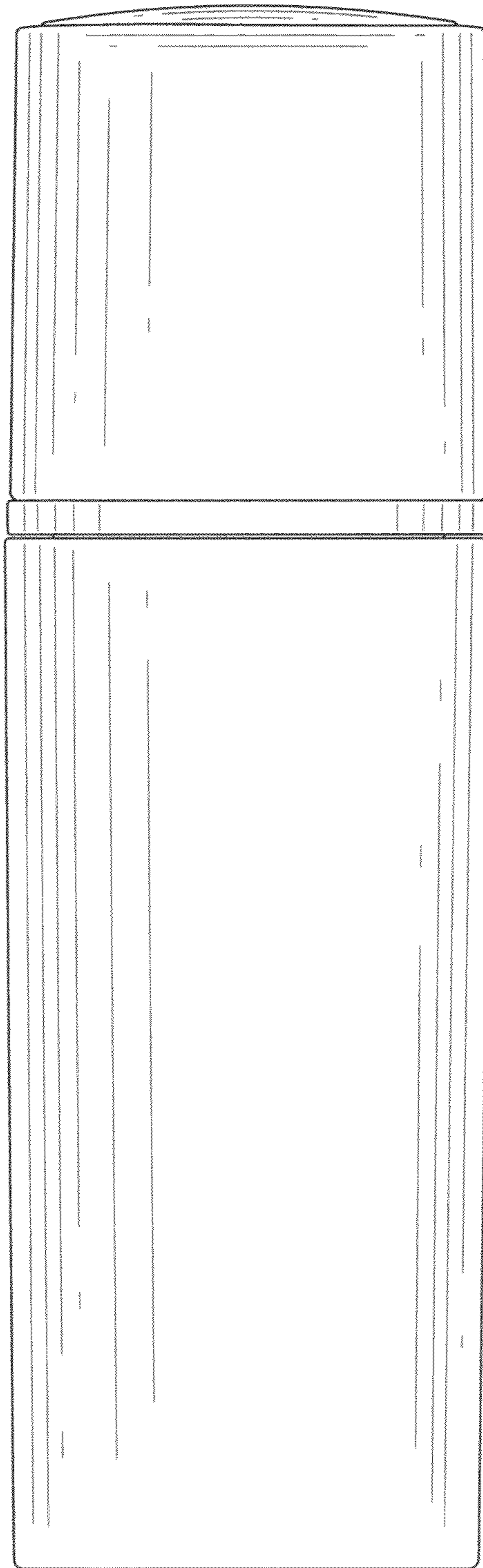

FIG. 6

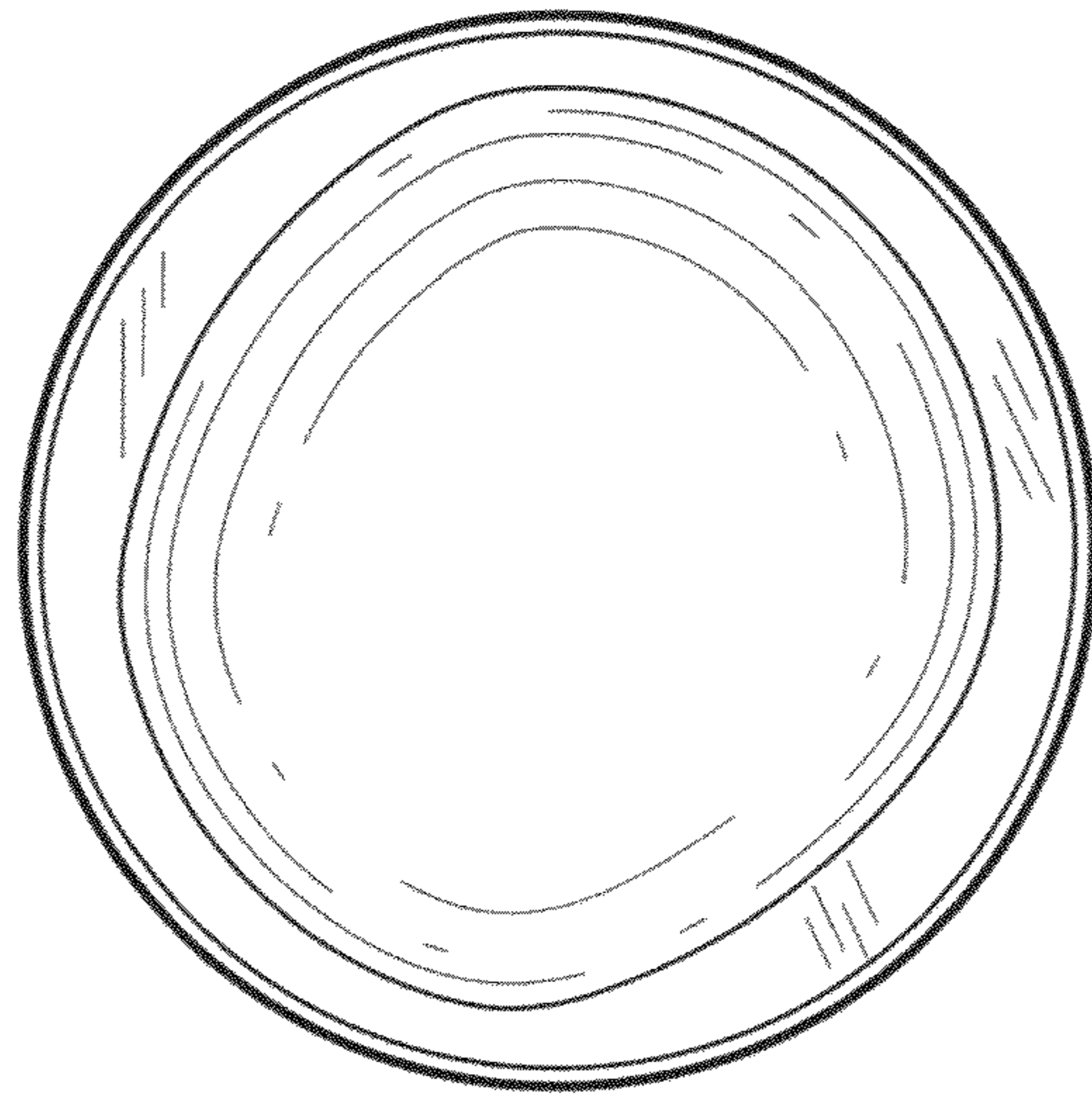

FIG. 7

