



US00D737085S

(12) **United States Design Patent**
Velez

(10) **Patent No.:** **US D737,085 S**

(45) **Date of Patent:** **** Aug. 25, 2015**

(54) **BENCH BASE**

(71) Applicant: **LANDSCAPE FORMS, INC.**,
Kalamazoo, MI (US)

(72) Inventor: **Efrain E. Velez**, Kalamazoo, MI (US)

(73) Assignee: **LANDSCAPE FORMS, INC.**,
Kalamazoo, MI (US)

(**) Term: **14 Years**

(21) Appl. No.: **29/511,185**

(22) Filed: **Dec. 8, 2014**

(51) **LOC (10) Cl.** **06-01**

(52) **U.S. Cl.**
USPC **D6/708.16**

(58) **Field of Classification Search**
USPC 22/334–338, 349, 355, 361, 368–370,
22/376, 379–381, 716, 716.1, 716.2, 340,
22/354, 377, 709, 710, 716.4, 367,
22/708.16; 297/16.1, 42, 94, 135, 175,
297/232, 233, 350, 351, 445.1, 448.1,
297/448.2, 451.9, 452.1, DIG. 7; 5/12.1,
5/12.2
CPC A47C 1/02; A47C 1/024; A47C 7/18;
A47C 7/24; A47C 17/00; A47C 17/02;
A47C 17/175

See application file for complete search history.

(56) **References Cited**

U.S. PATENT DOCUMENTS

D171,265 S * 1/1954 Phillips D6/375
D172,858 S * 8/1954 Yellen D6/375
D249,414 S * 9/1978 Adkinson D6/334
D279,338 S * 6/1985 Offredi D6/376
D292,048 S * 9/1987 Shaffer D6/363
D295,238 S * 4/1988 Gammelgaard D6/373
D530,112 S * 10/2006 Wilson et al. D6/381

D569,640 S * 5/2008 Robson D6/370
D585,207 S * 1/2009 Bauchet D6/375
D613,953 S * 4/2010 Hammer D6/310
D723,828 S * 3/2015 Rose D6/381

OTHER PUBLICATIONS

Olithas Table and Benches, manufactured by Landscape Forms, Inc., designed by Efrain E. Velez, printout available online on Dec. 6, 2014 at: <http://www.landscapeforms.com/en-US/site-furniture/pages/Olithas.aspx>, 2 page.

Evia Bench/Lounge, manufactured by Galanter & Jones, designed by Aaron Gore, printout available online on Dec. 6, 2014 at: <http://www.galanterandjones.com/product/evia-white>, 2 page.

Modern Beach House Concrete Bench, manufactured by Gore Design Co., LLC, designed by Brandon Gore, printout available online on Dec. 6, 2014 at: <http://www.houzz.com/photos/11911674/Modern-Beach-House-Concrete-Bench-beach-style-outdoor-stools-and-benches-phoenix>, 1 page.

(Continued)

Primary Examiner — Sandra Snapp

(74) *Attorney, Agent, or Firm* — Heslin Rothenberg Farley & Mesiti P.C.

(57) **CLAIM**

The ornamental design for a bench base, as shown and described.

DESCRIPTION

FIG. 1 is a perspective view of the bench base of the present invention;

FIG. 2 is a front elevation view thereof;

FIG. 3 is a rear elevation view thereof;

FIG. 4 is a right side elevation view thereof; the left side elevation view being a mirror image thereof;

FIG. 5 is a top plan view thereof; and,

FIG. 6 is a bottom plan view thereof.

The broken lines shown in the drawings depict features that form no part of the claimed design.

1 Claim, 6 Drawing Sheets

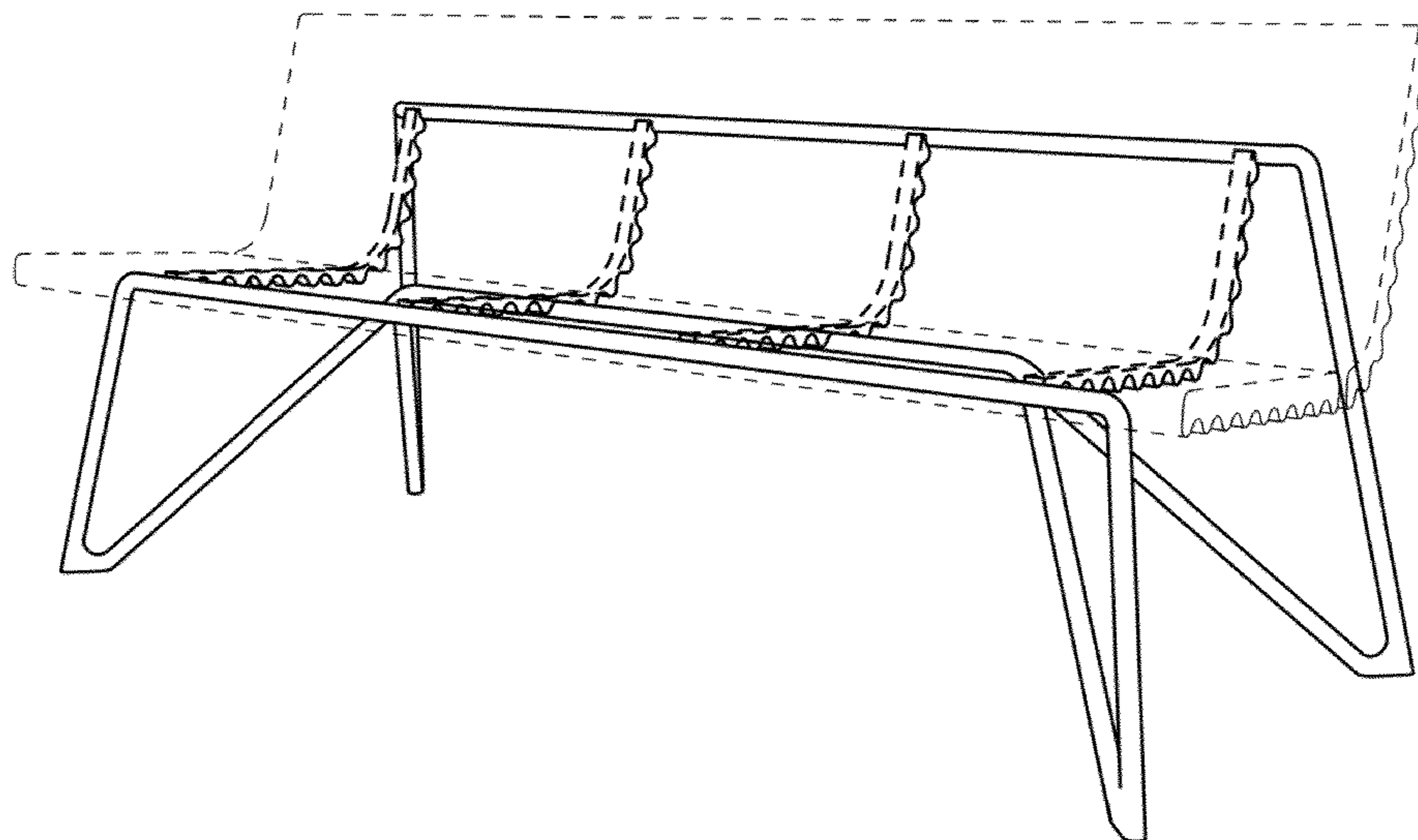

(56)

References Cited

OTHER PUBLICATIONS

Strata Bench, manufactured by Landscape Forms, Inc., designed by Jes Sorell, printout available online on Dec. 6, 2014 at: <http://www.landscapeforms.com/en-US/ProductData/pp./STRATABench.aspx>, 2 pages.

Vilnius Bench, manufactured by Escofet, designed by Gae Bedito, printout available online on Dec. 6, 2014 at: http://escofet.com/pp./productos/ficha_productos.aspx?IdP=168&FA, 2 pages.

Bruno Bench, manufactured by Escofet, designed by Miguel and Gonzalo Mila, printout available online on Dec. 6, 2014 at: http://escofet.com/pages/productos/ficha_productos.aspx2IdP=199&FA, 2 pages.

* cited by examiner

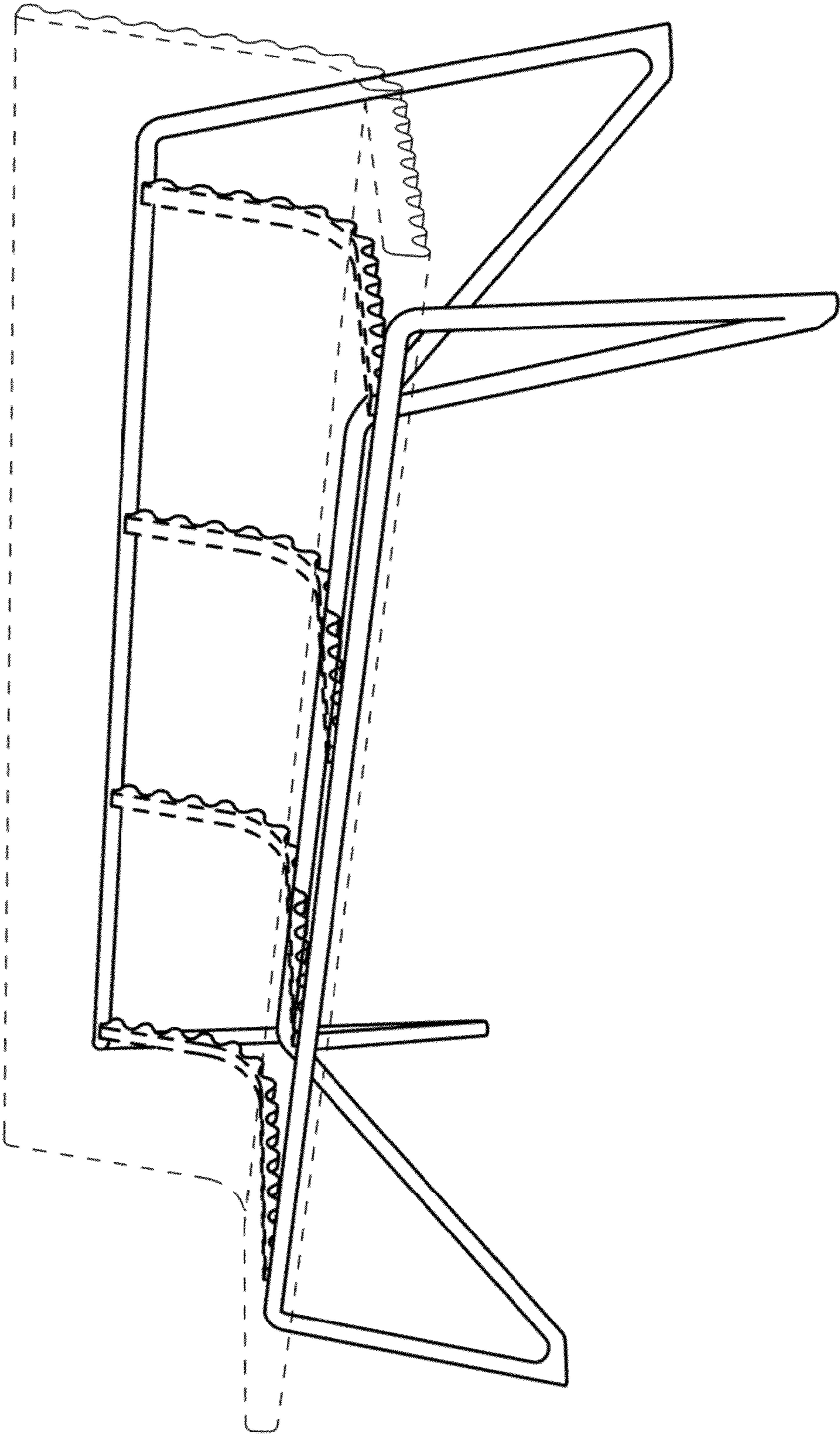

FIG. 1

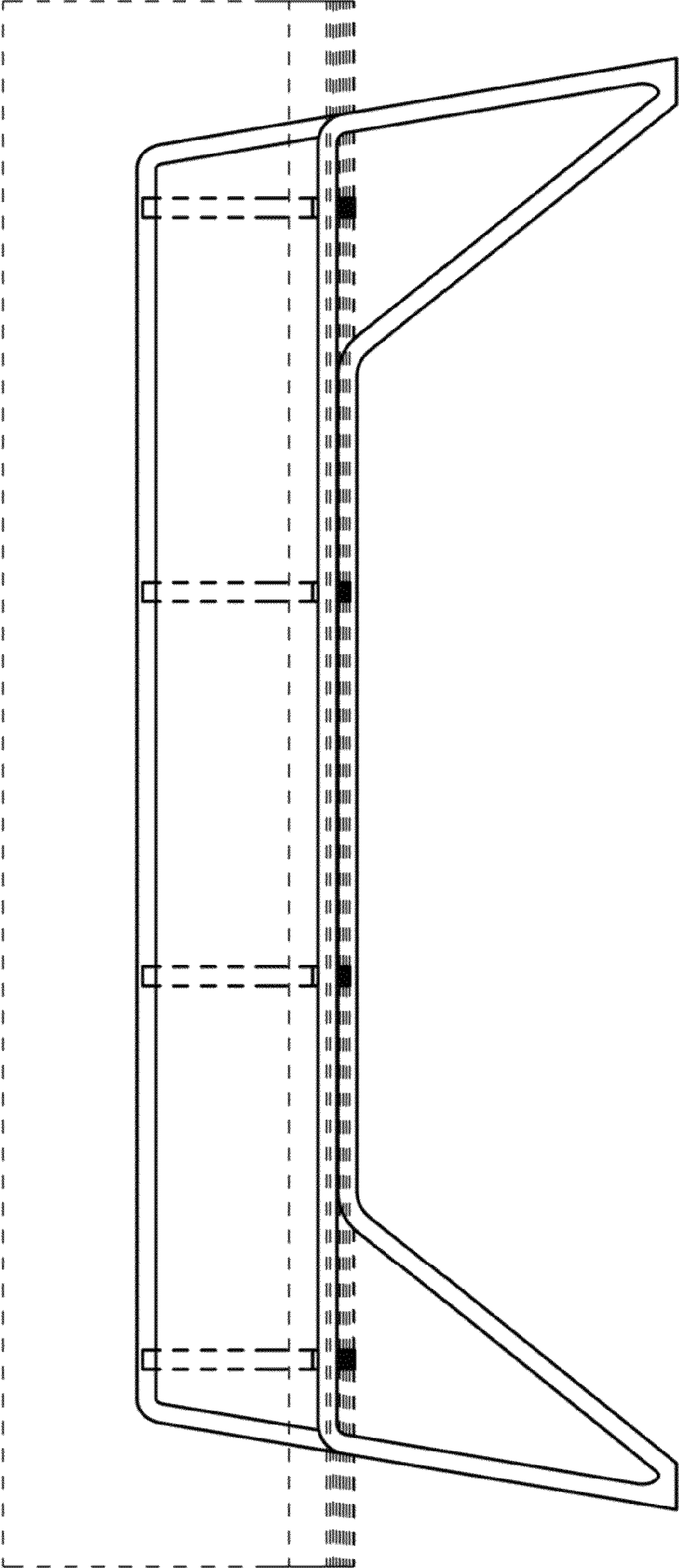

FIG. 2

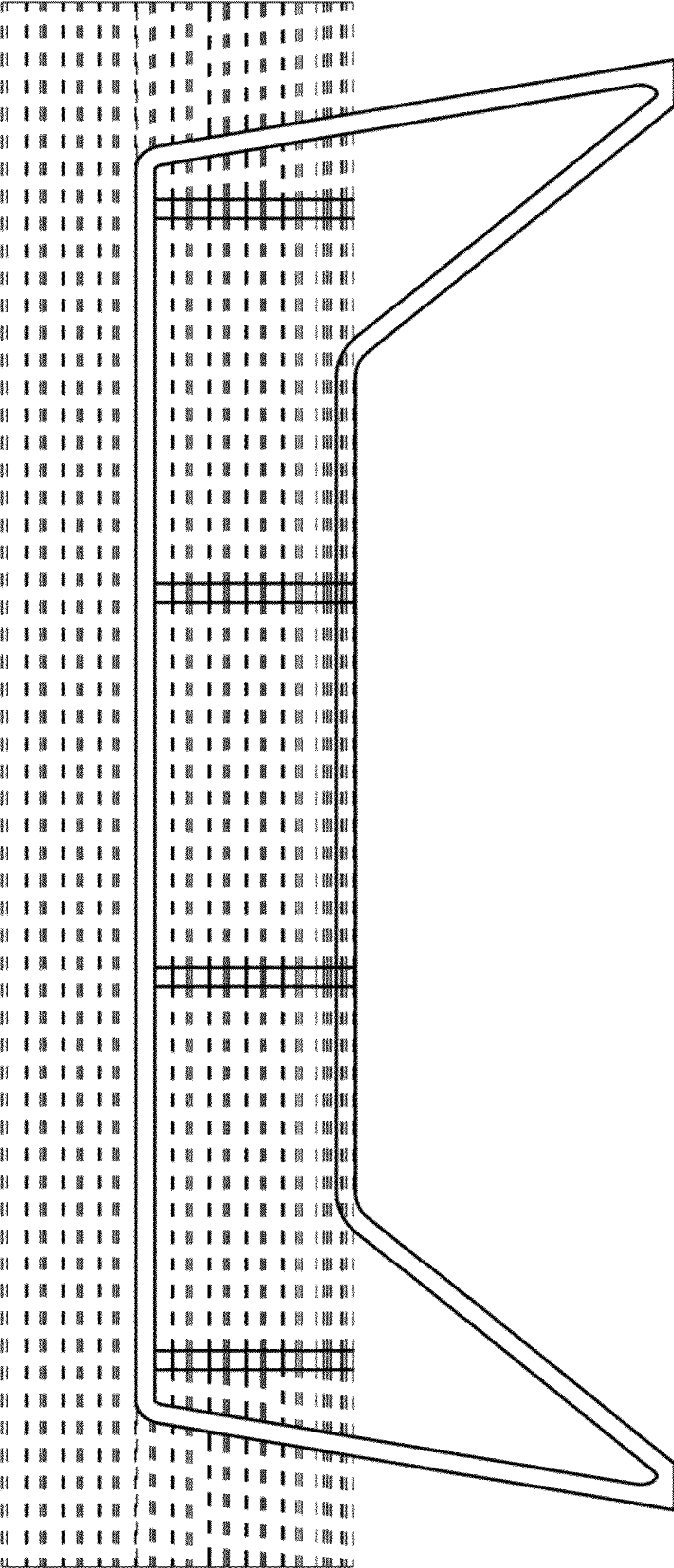

FIG. 3

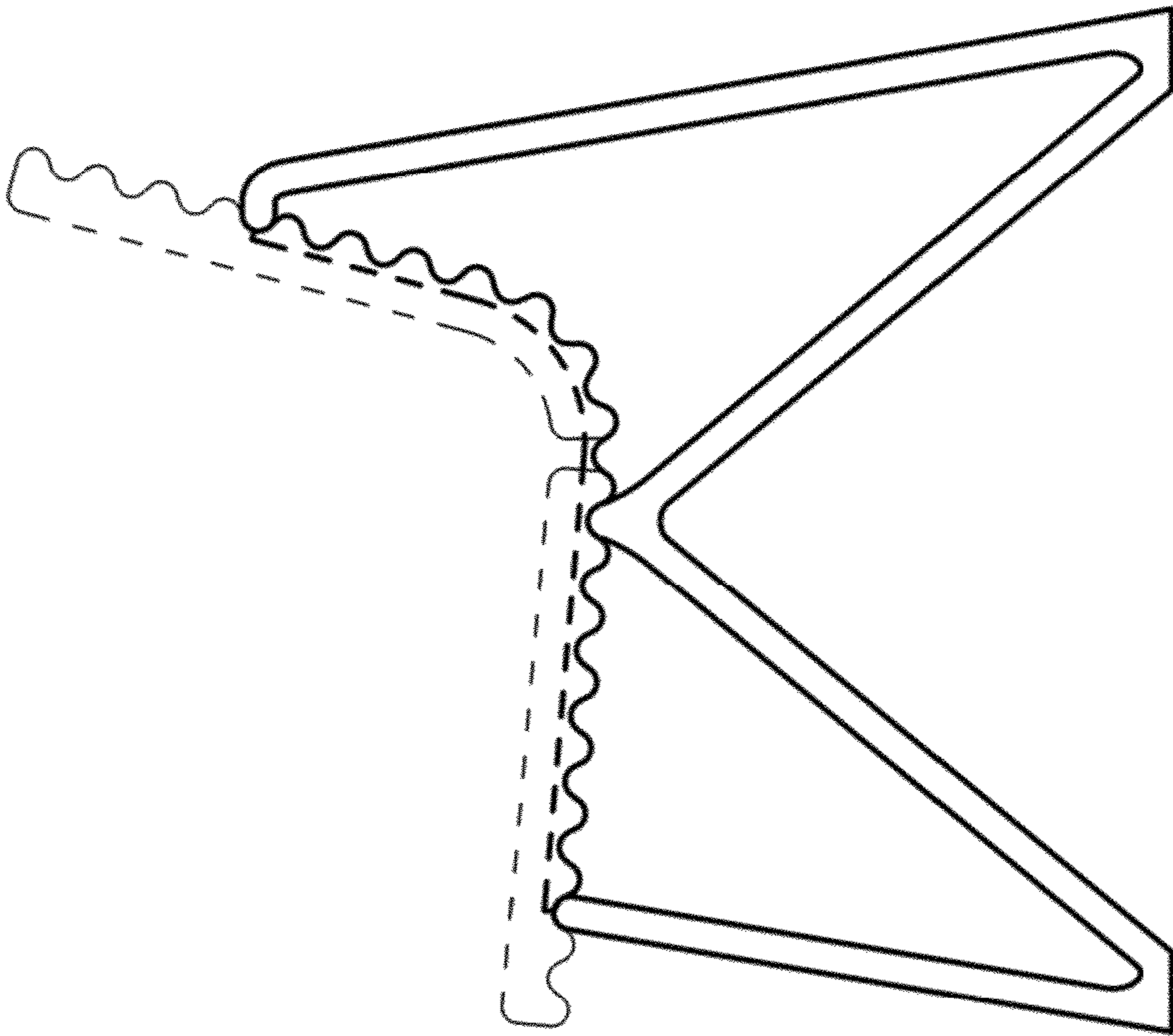

FIG.4

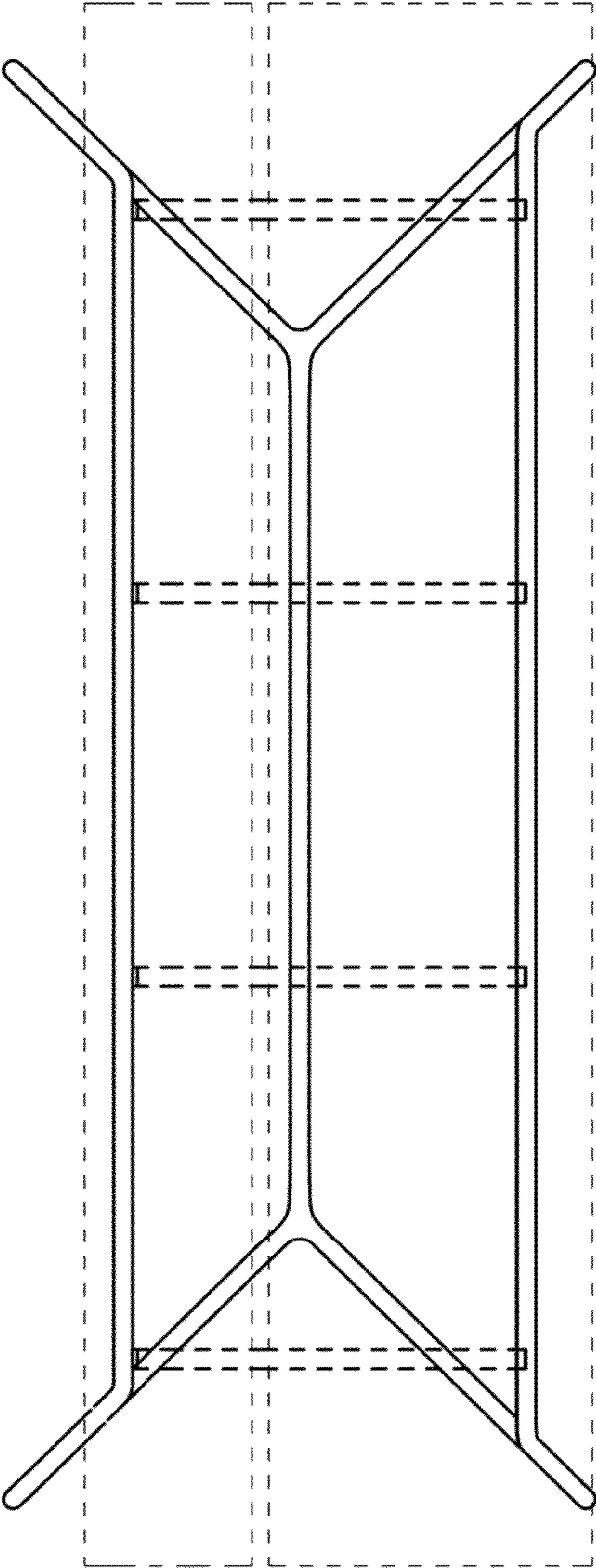

FIG. 5

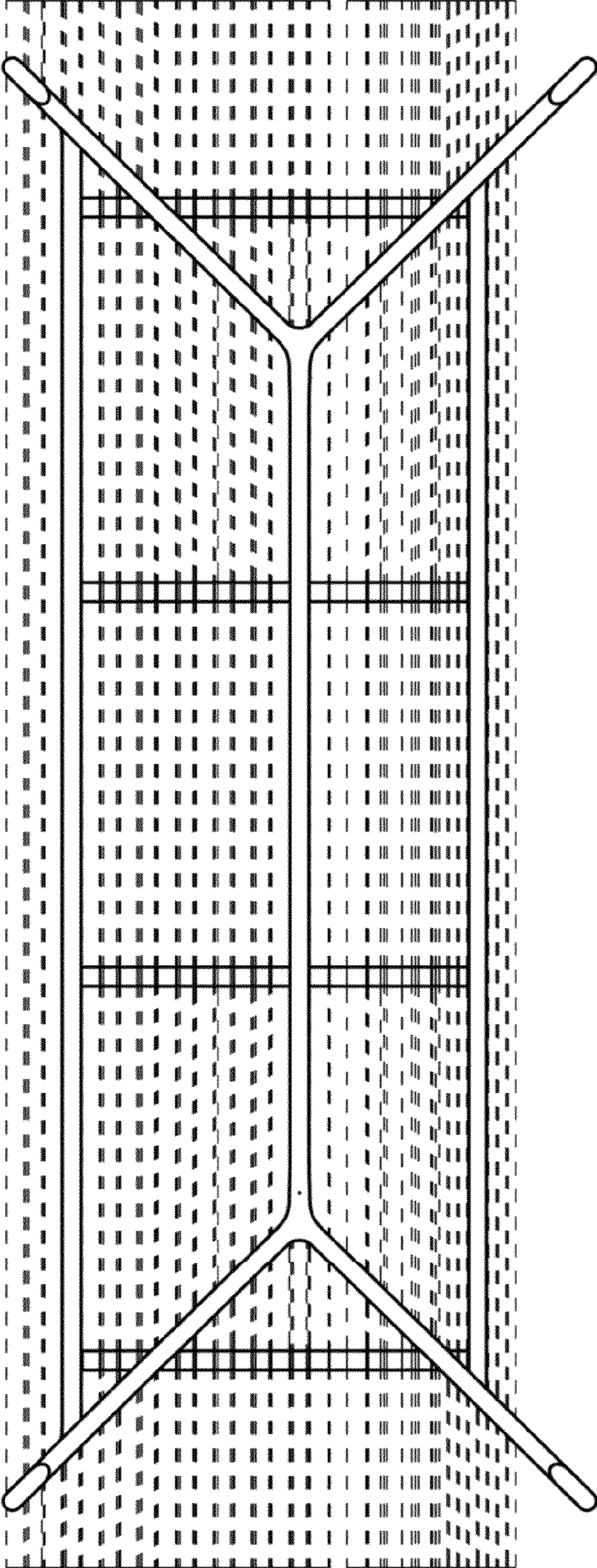

FIG. 6