



US00D737070S

(12) **United States Design Patent**
Sonmez

(10) **Patent No.:** **US D737,070 S**

(45) **Date of Patent:** **** Aug. 25, 2015**

(54) **FURNITURE ITEM**

(71) Applicant: **BOYTAS MOBILYA SANAYI VE TICARET ANONIM SIRKETI,**
Kayseri (TR)

(72) Inventor: **Osman Tanzer Sonmez,** Kayseri (TR)

(73) Assignee: **BOYTAS MOBILYA SANAYI VE TICARET ANONIM SIRKETI,**
Kayseri (TR)

(**) Term: **14 Years**

(21) Appl. No.: **29/512,957**

(22) Filed: **Dec. 23, 2014**

(51) **LOC (10) Cl.** **06-01**

(52) **U.S. Cl.**
USPC **D6/381**

(58) **Field of Classification Search**
USPC D6/334–338, 349, 355, 361, 368–370,
D6/376, 379–381, 716, 716.1, 716.2, 340,
D6/354, 377, 709, 710, 716.4, 367;
297/16.1, 42, 94, 135, 175, 232, 233,
297/350, 351, 445.1, 448.1, 448.2, 451.9,
297/452.1, DIG. 7; 5/12.1, 12.2
CPC A47C 1/02; A47C 1/024; A47C 7/18;
A47C 7/24; A47C 17/00; A47C 17/02;
A47C 17/175

See application file for complete search history.

(56) **References Cited**

U.S. PATENT DOCUMENTS

5,329,654	A	*	7/1994	Sherman	5/14
D485,687	S	*	1/2004	Natuzzi	D6/334
D552,867	S	*	10/2007	Natuzzi	D6/381
D572,916	S	*	7/2008	Galardo et al.	D6/334
D719,754	S	*	12/2014	Pathiratne	D6/381
D720,942	S	*	1/2015	Schweikarth	D6/379

* cited by examiner

Primary Examiner — Sandra Snapp

(74) *Attorney, Agent, or Firm* — Inventa Capital PLC

(57) **CLAIM**

I claim the ornamental design for a furniture item, as shown and described.

DESCRIPTION

FIG. 1 is a perspective view of a first embodiment of a furniture item of the present invention;
FIG. 2 is a front perspective view of the furniture item;
FIG. 3 is a rear perspective view of the furniture item;
FIG. 4 is a right side perspective view of the furniture item;
FIG. 5 is a left side perspective view of the furniture item;
FIG. 6 is a top perspective view of the furniture item;
FIG. 7 is a bottom perspective view of the furniture item;
FIG. 8 is a perspective view of a second embodiment of a furniture item of the present invention;
FIG. 9 is a front perspective view of the furniture item;
FIG. 10 is a rear perspective view of the furniture item;
FIG. 11 is a right side perspective view of the furniture item;
FIG. 12 is a left side perspective view of the furniture item;
FIG. 13 is a top perspective view of the furniture item;
FIG. 14 is a bottom perspective view of the furniture item;
FIG. 15 is a perspective view of a third embodiment of a furniture item of the present invention;
FIG. 16 is a front perspective view of the furniture item;
FIG. 17 is a rear perspective view of the furniture item;
FIG. 18 is a right side perspective view of the furniture item;
FIG. 19 is a left side perspective view of the furniture item;
FIG. 20 is a top perspective view of the furniture item; and,
FIG. 21 is a bottom perspective view of the furniture item.
The criss-cross pattern of lines in the drawings represent material that is understood to be distributed uniformly over the surface of the furniture item.

1 Claim, 21 Drawing Sheets

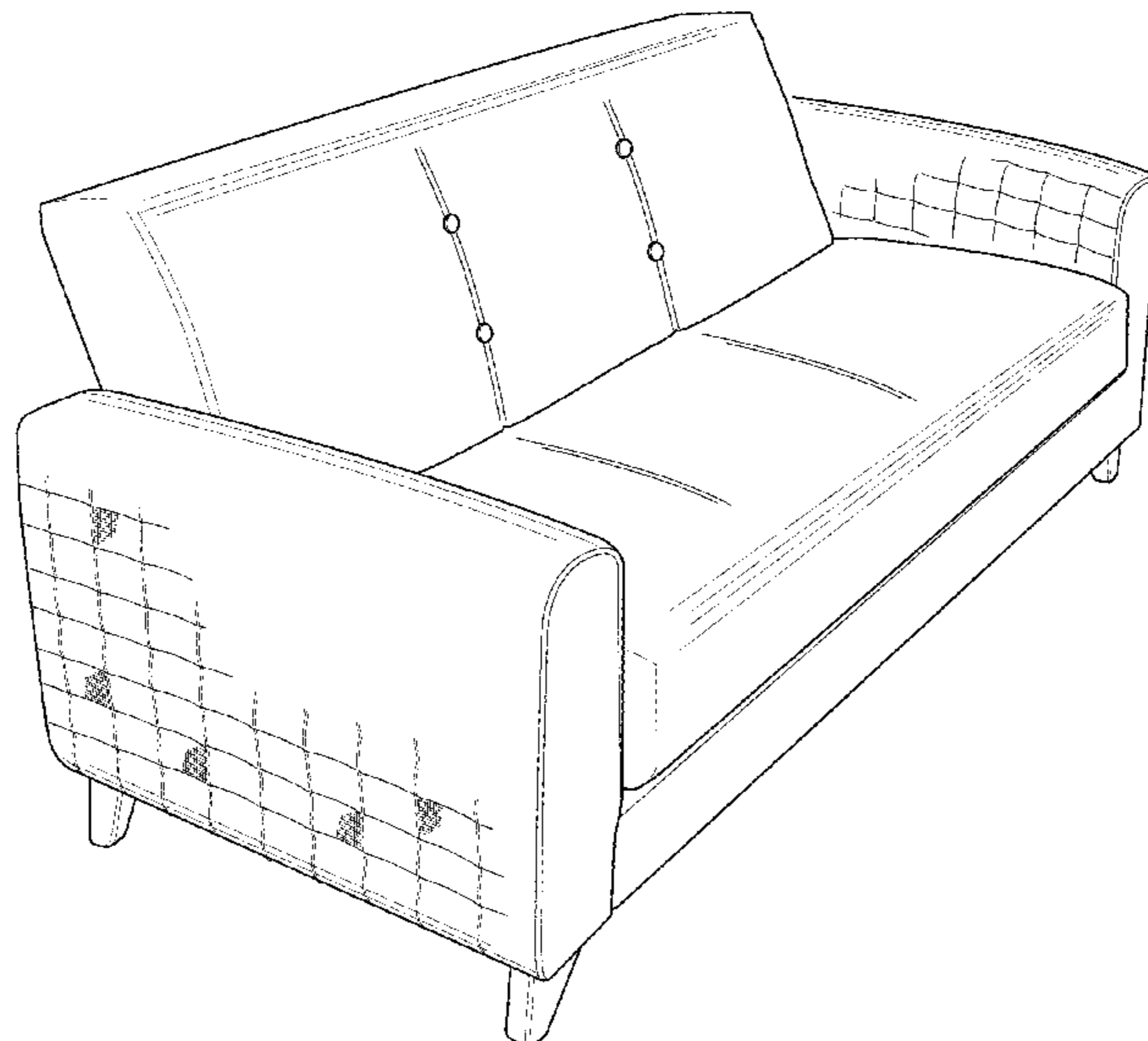
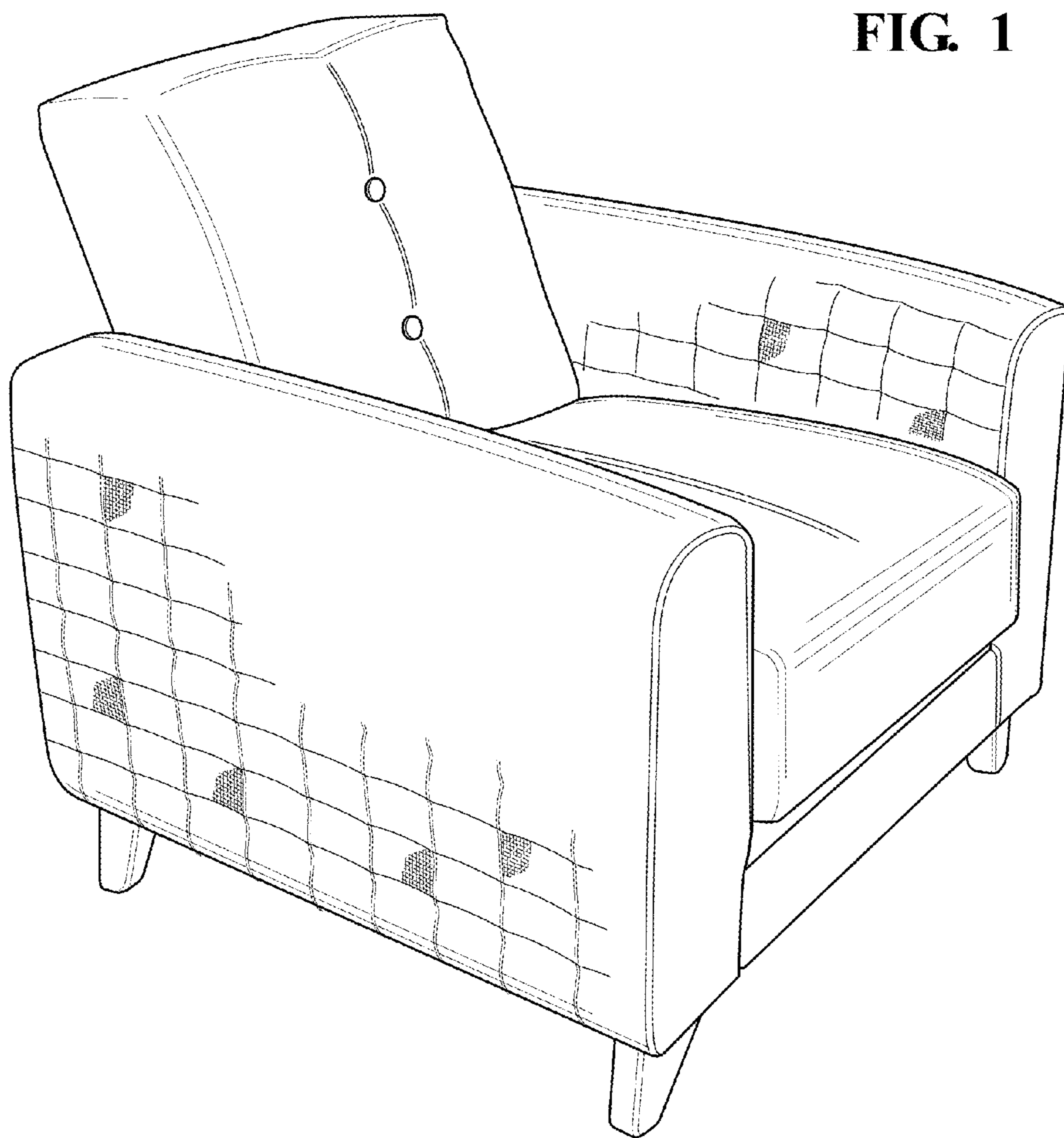

FIG. 1



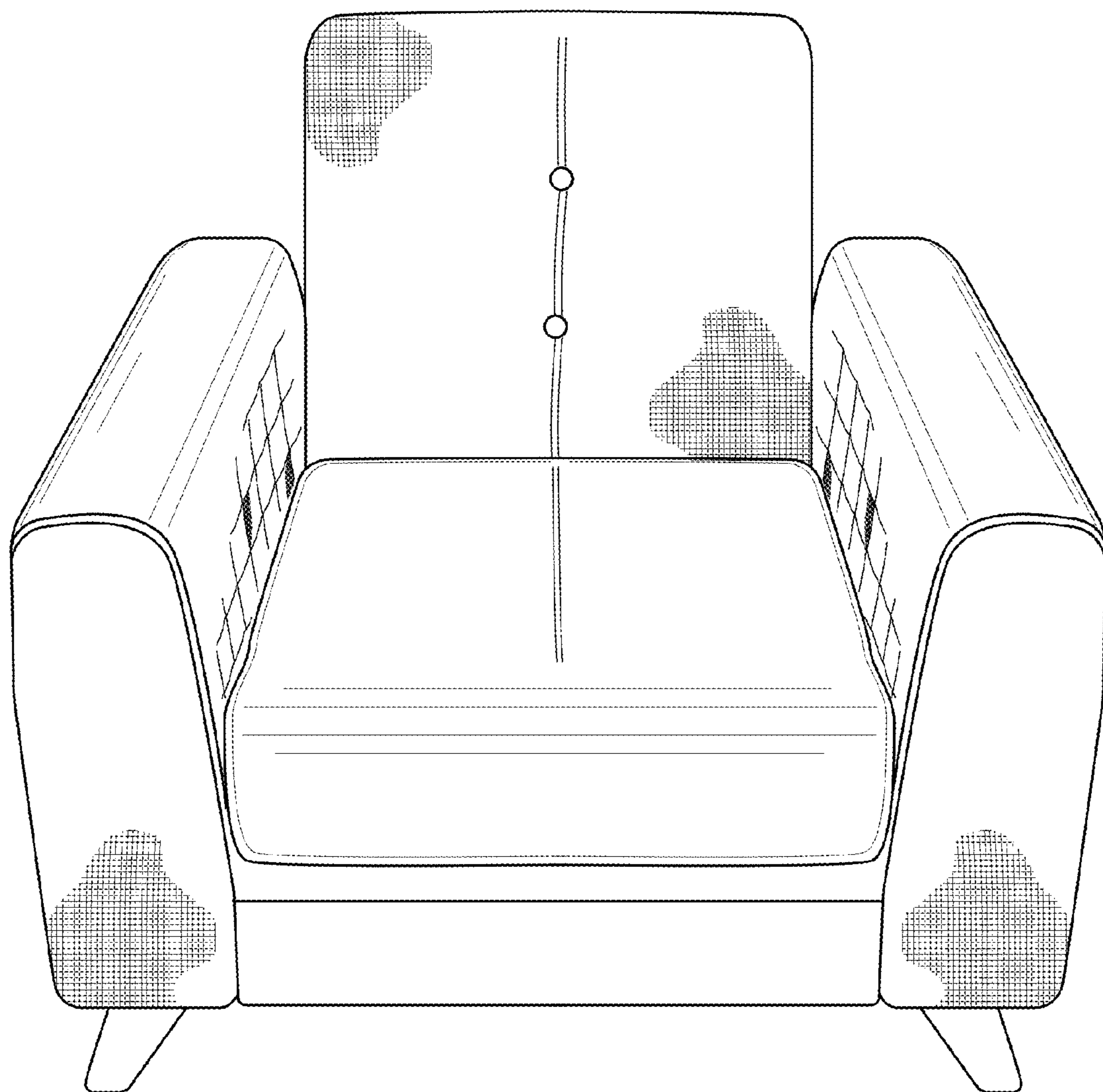

FIG. 2

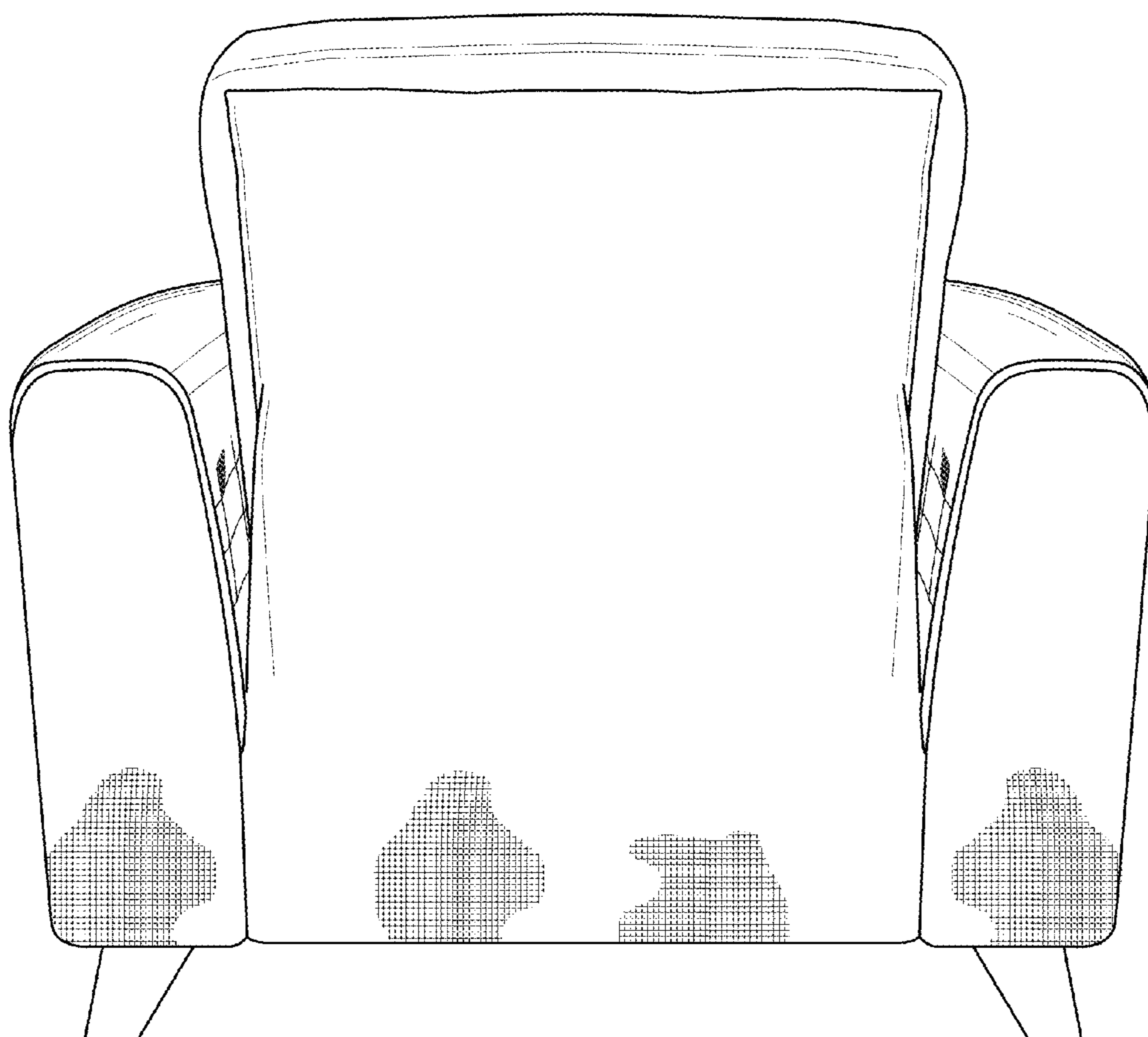
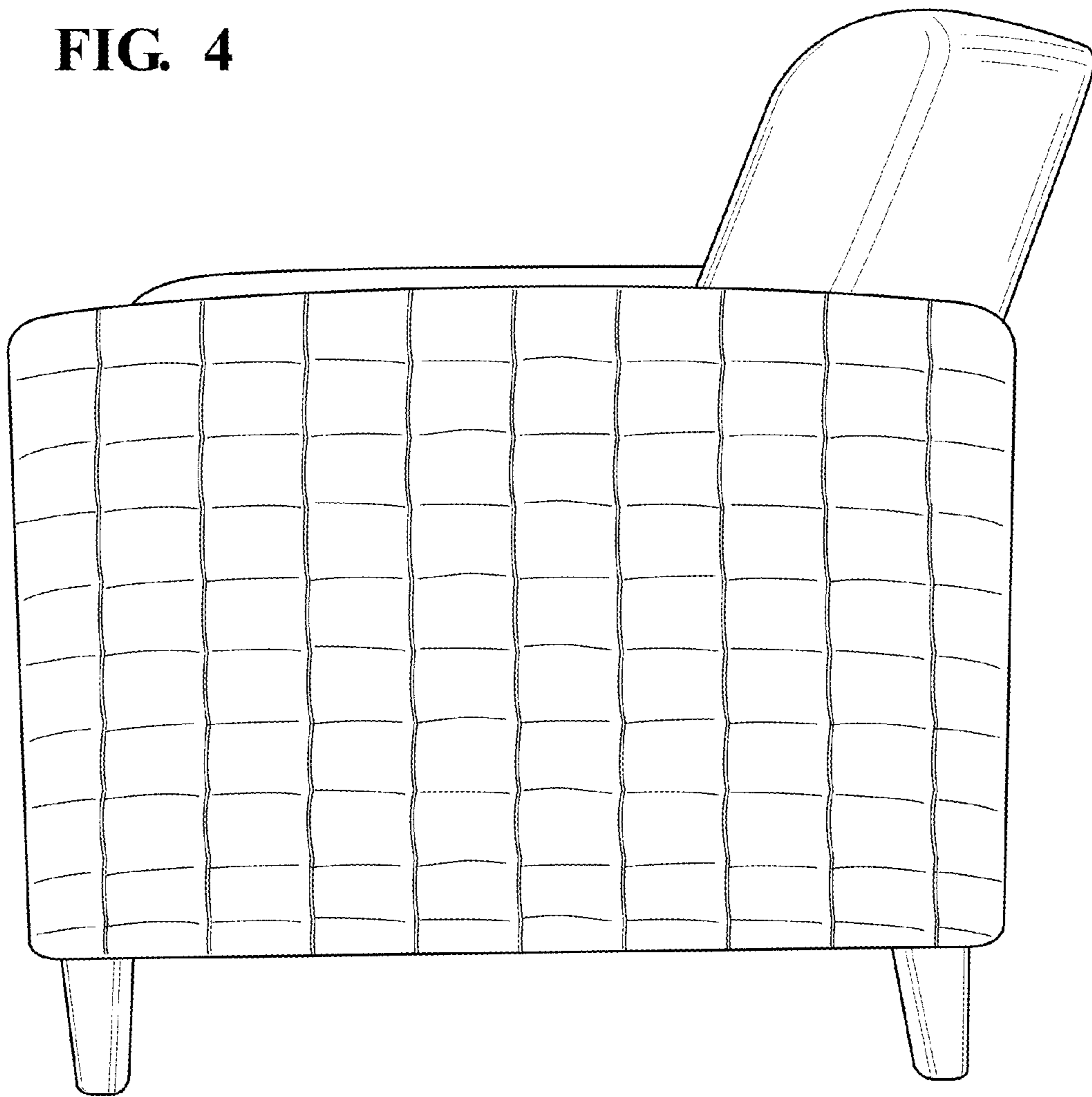

FIG. 3

FIG. 4



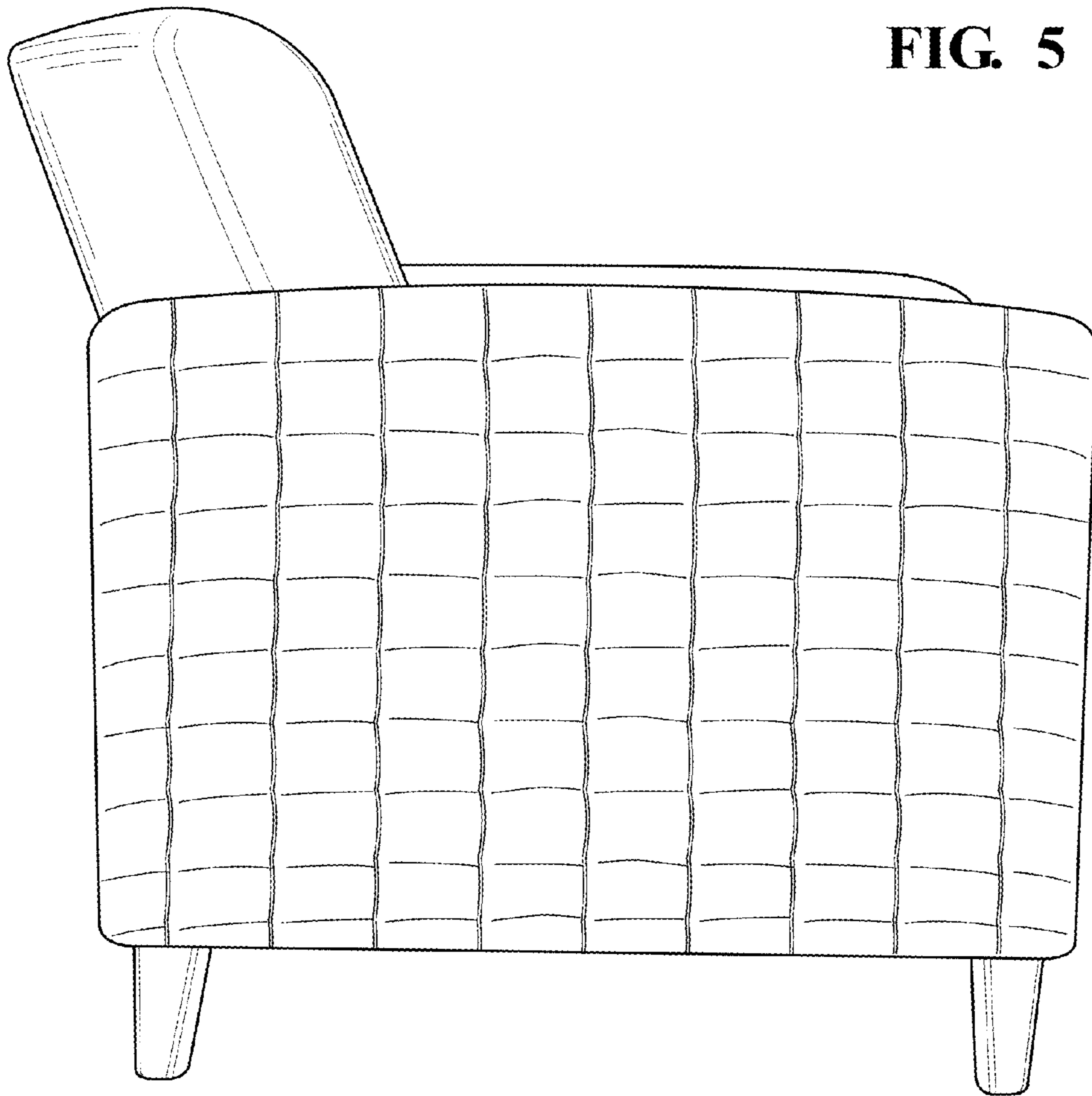

FIG. 5

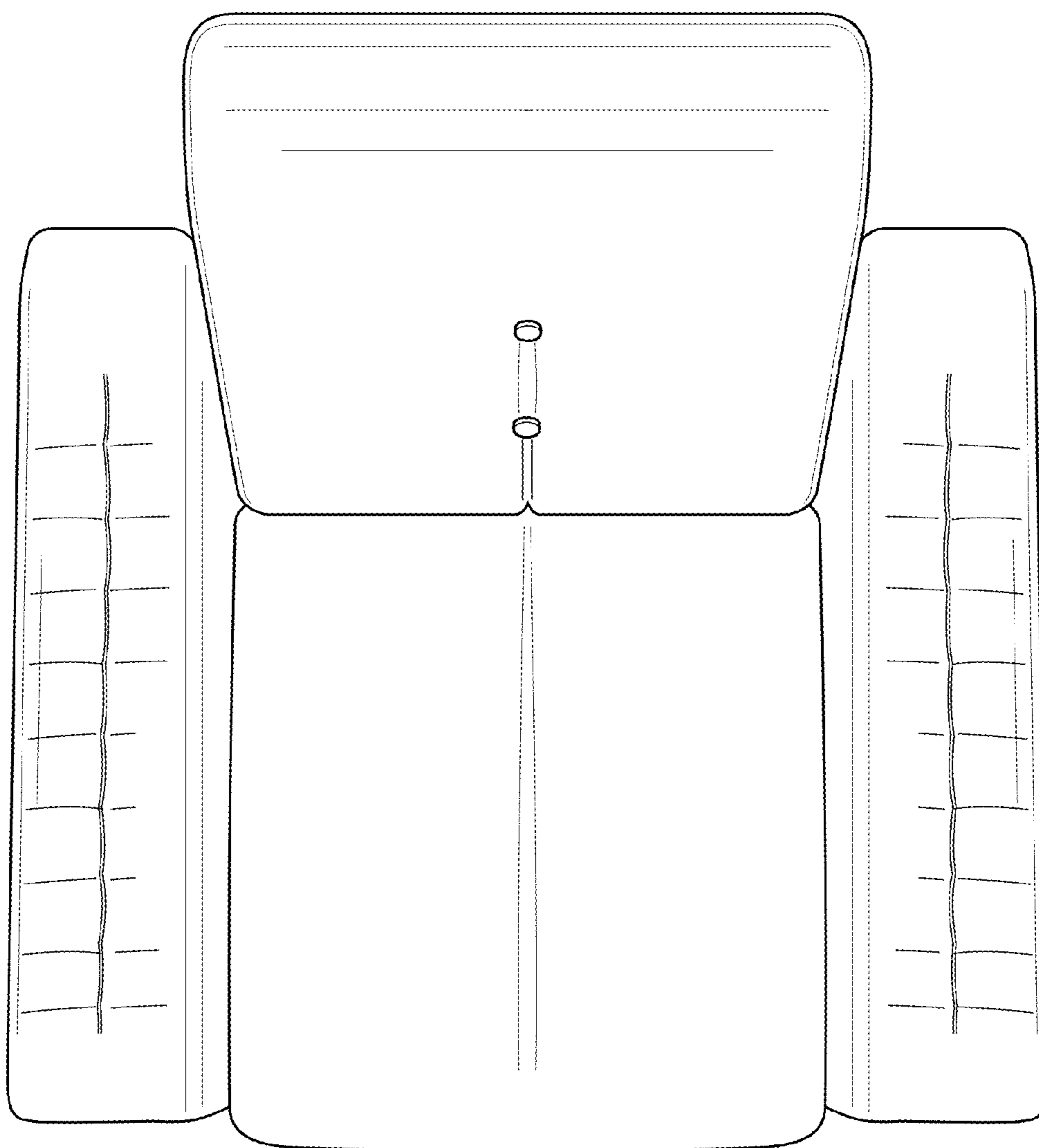

FIG. 6

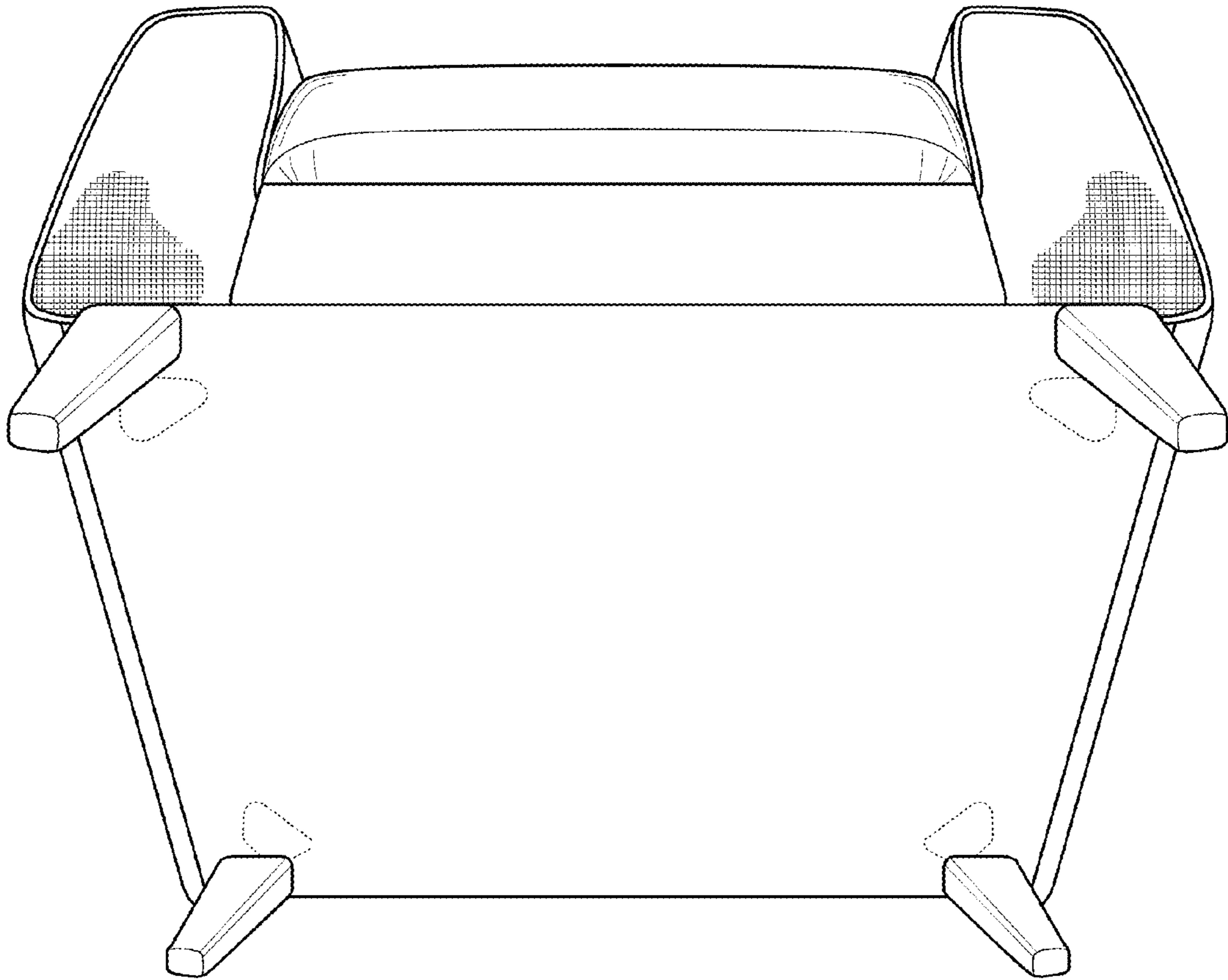

FIG. 7

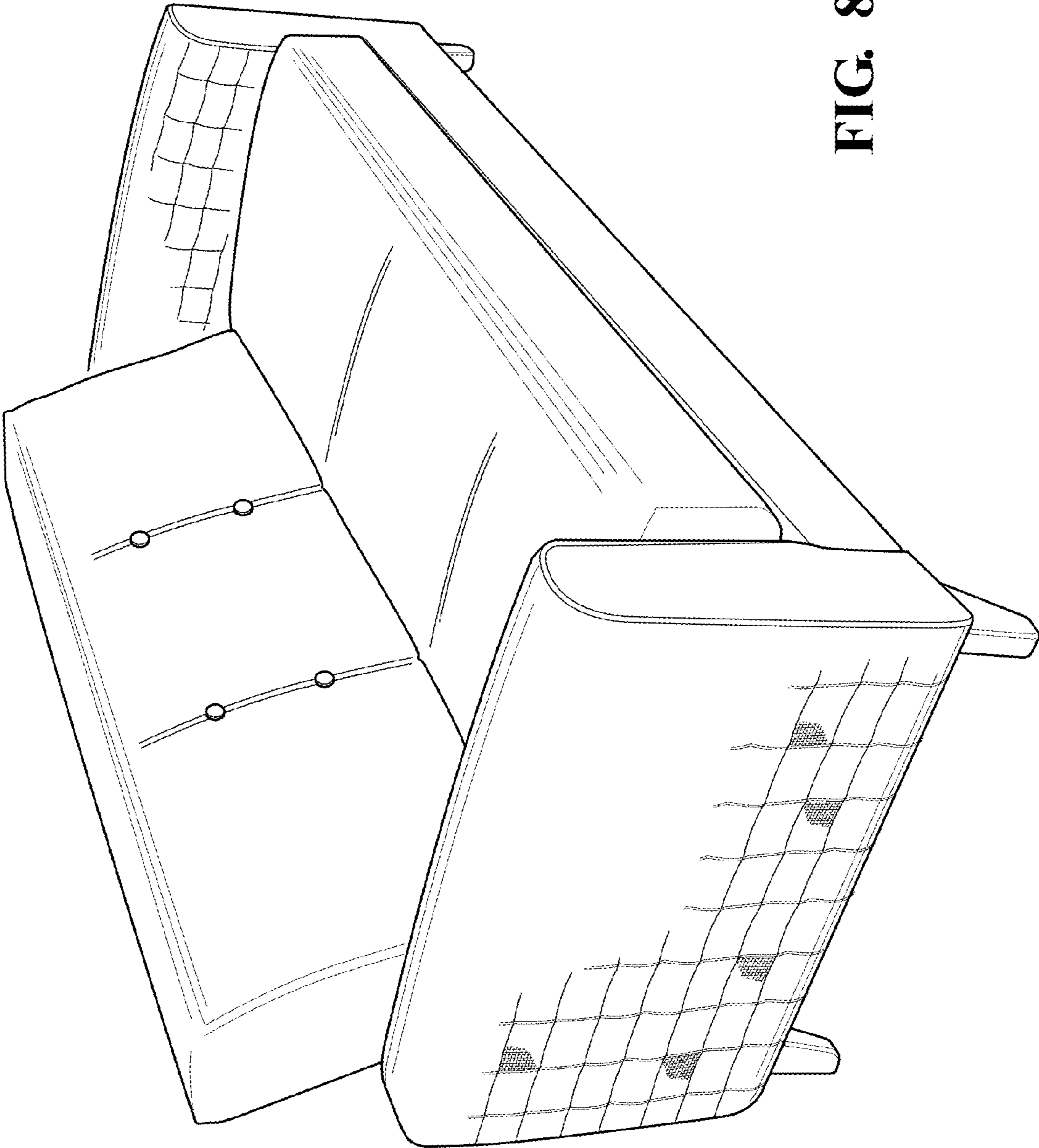

FIG. 8

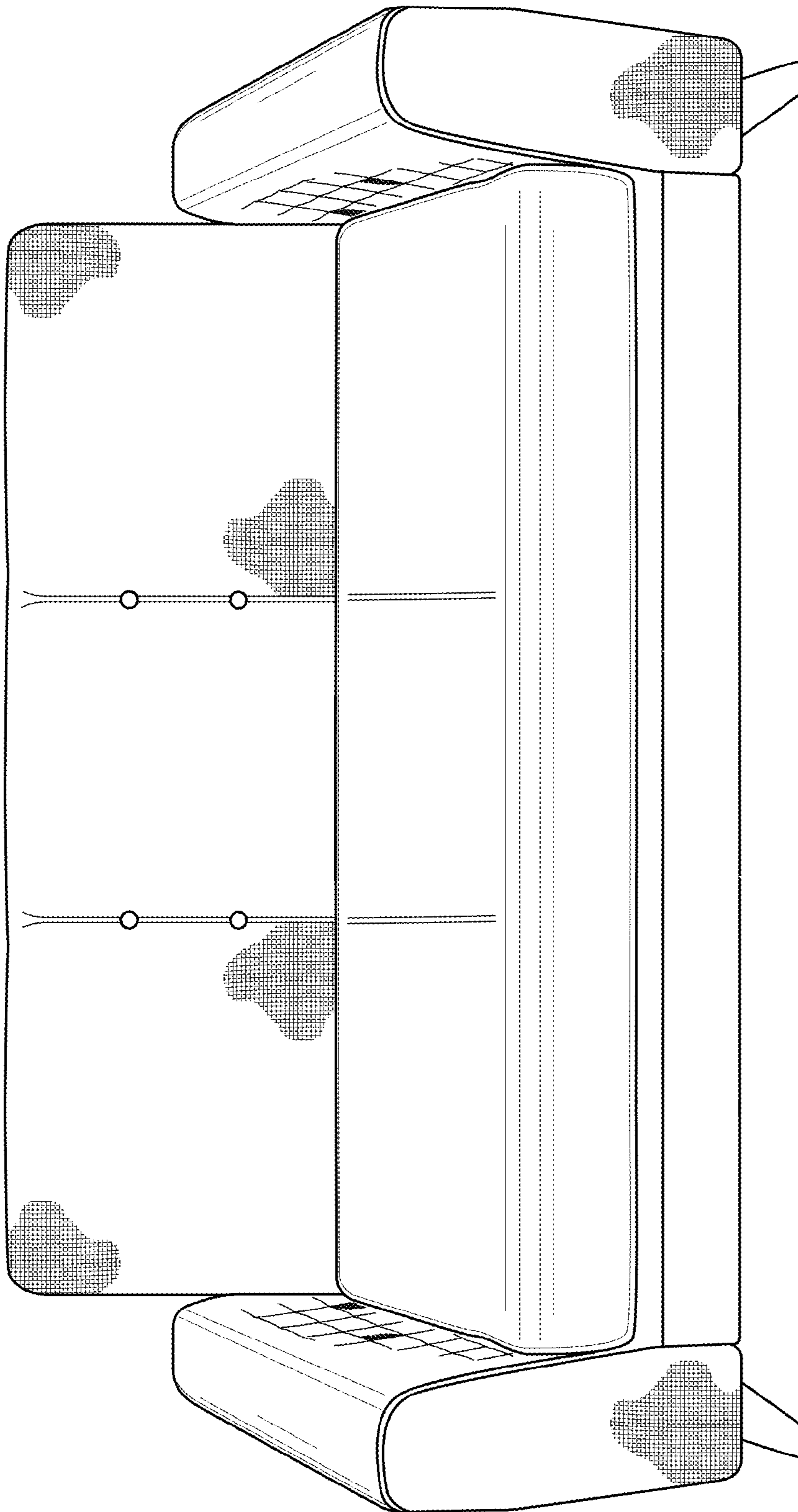

FIG. 9

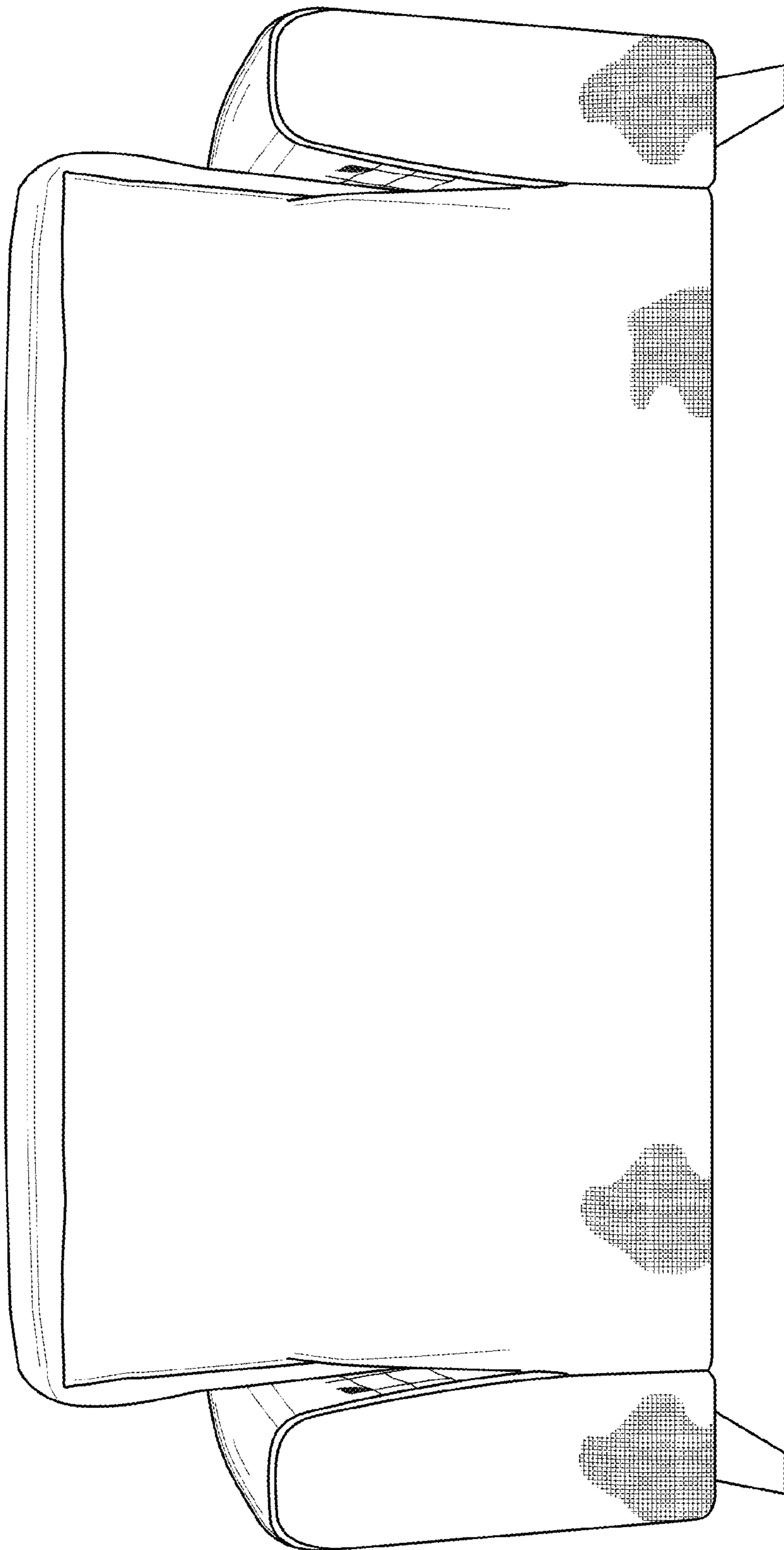

FIG. 10

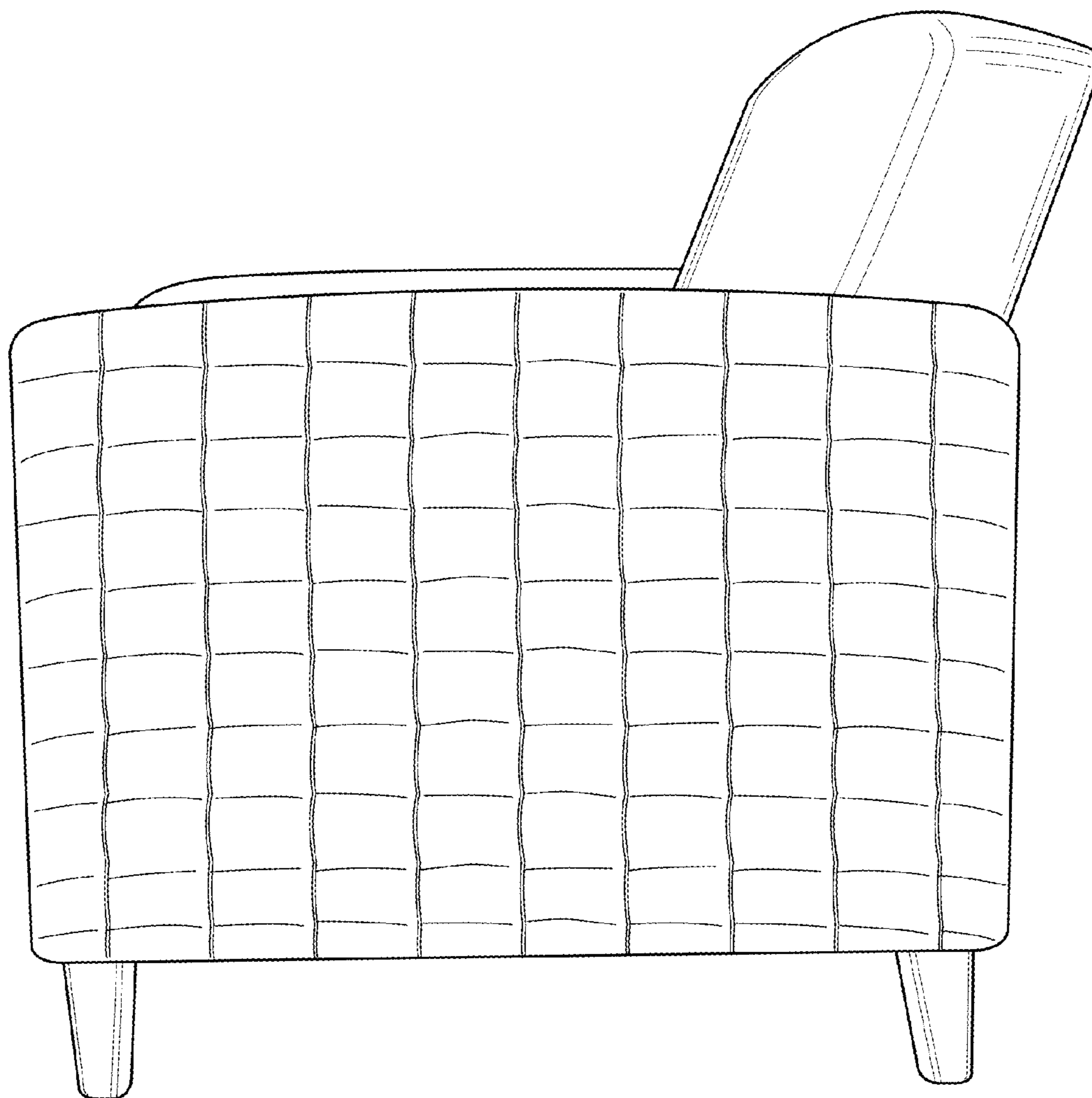

FIG. 11

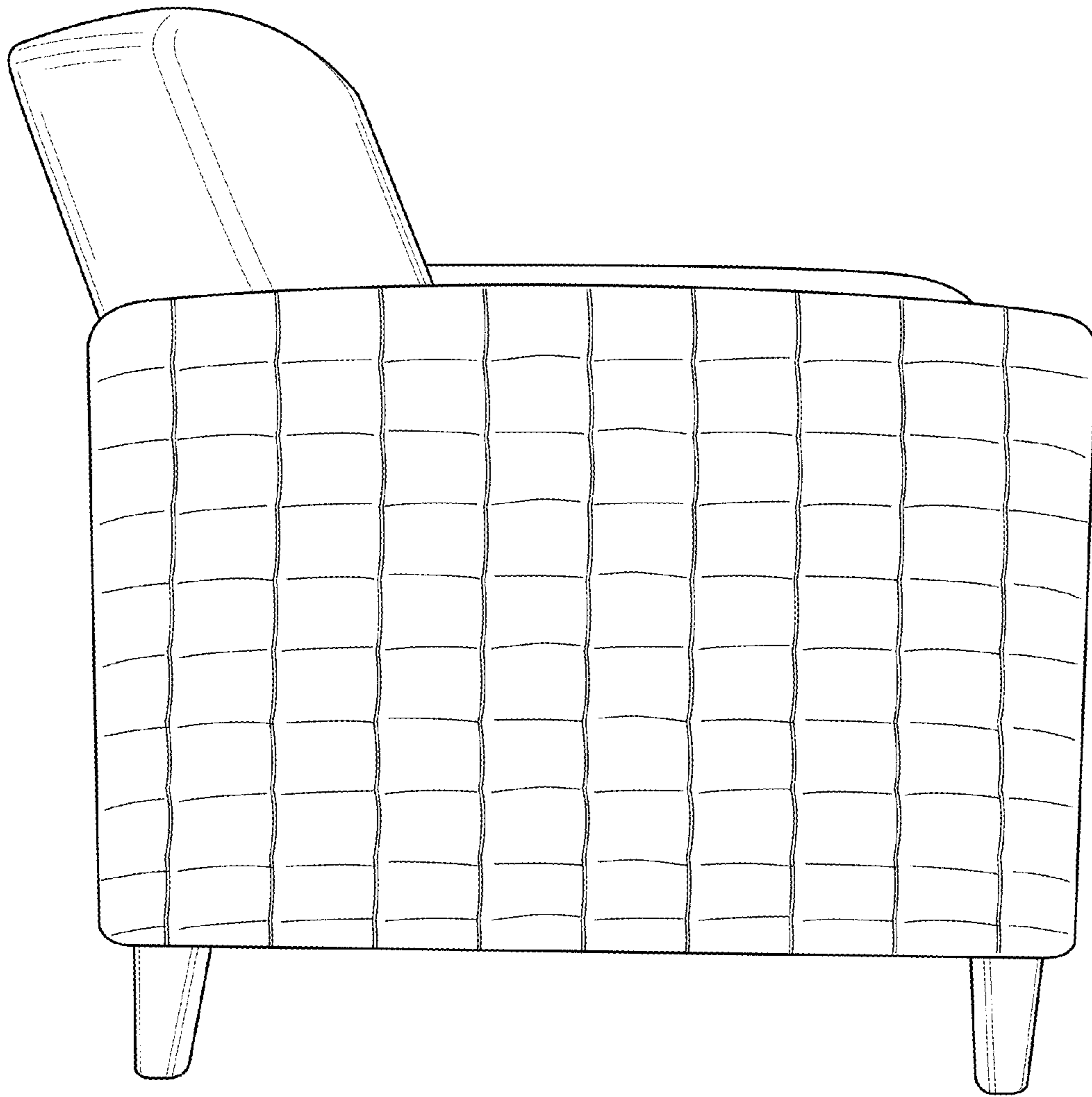

FIG. 12

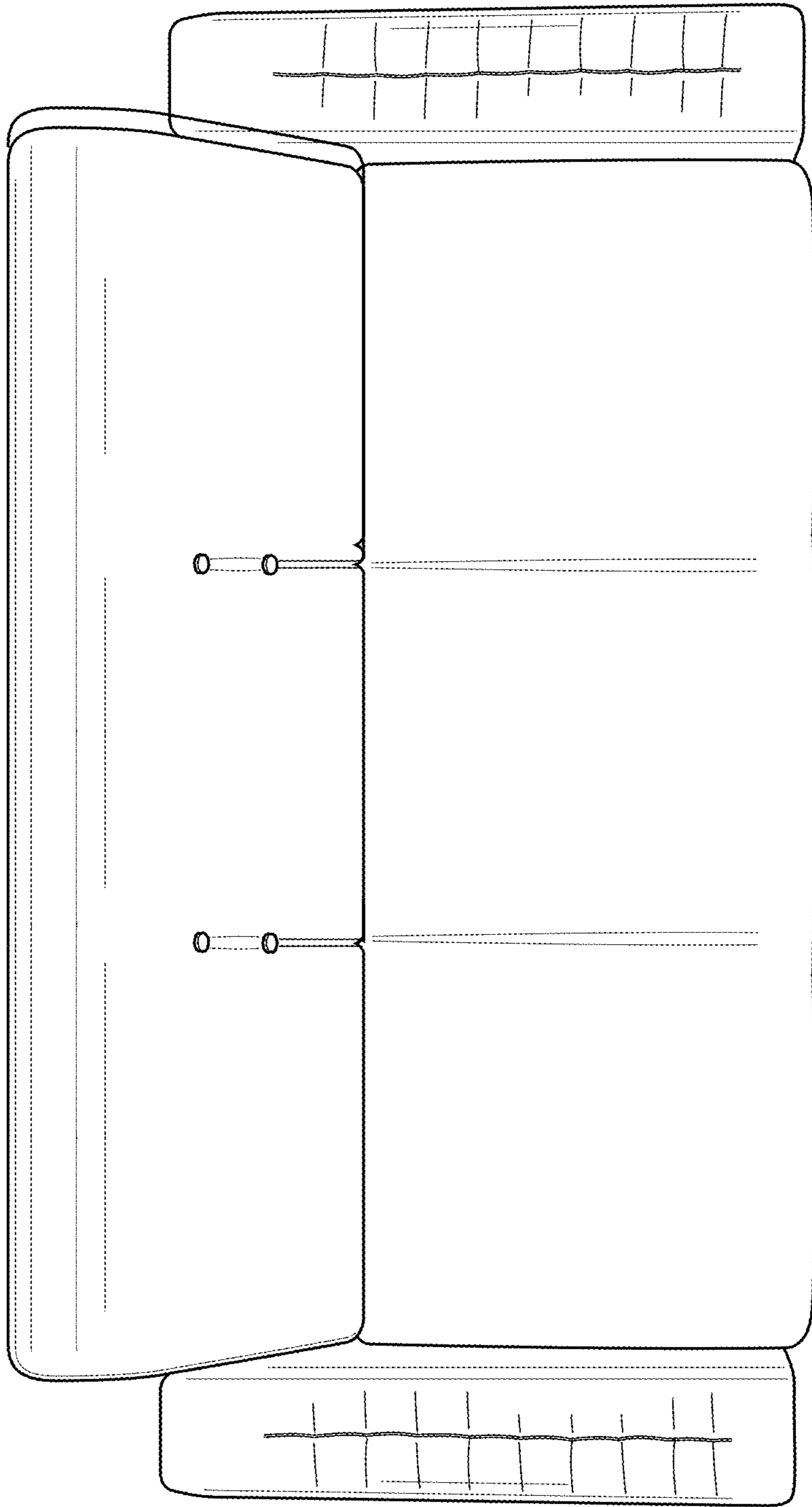

FIG. 13

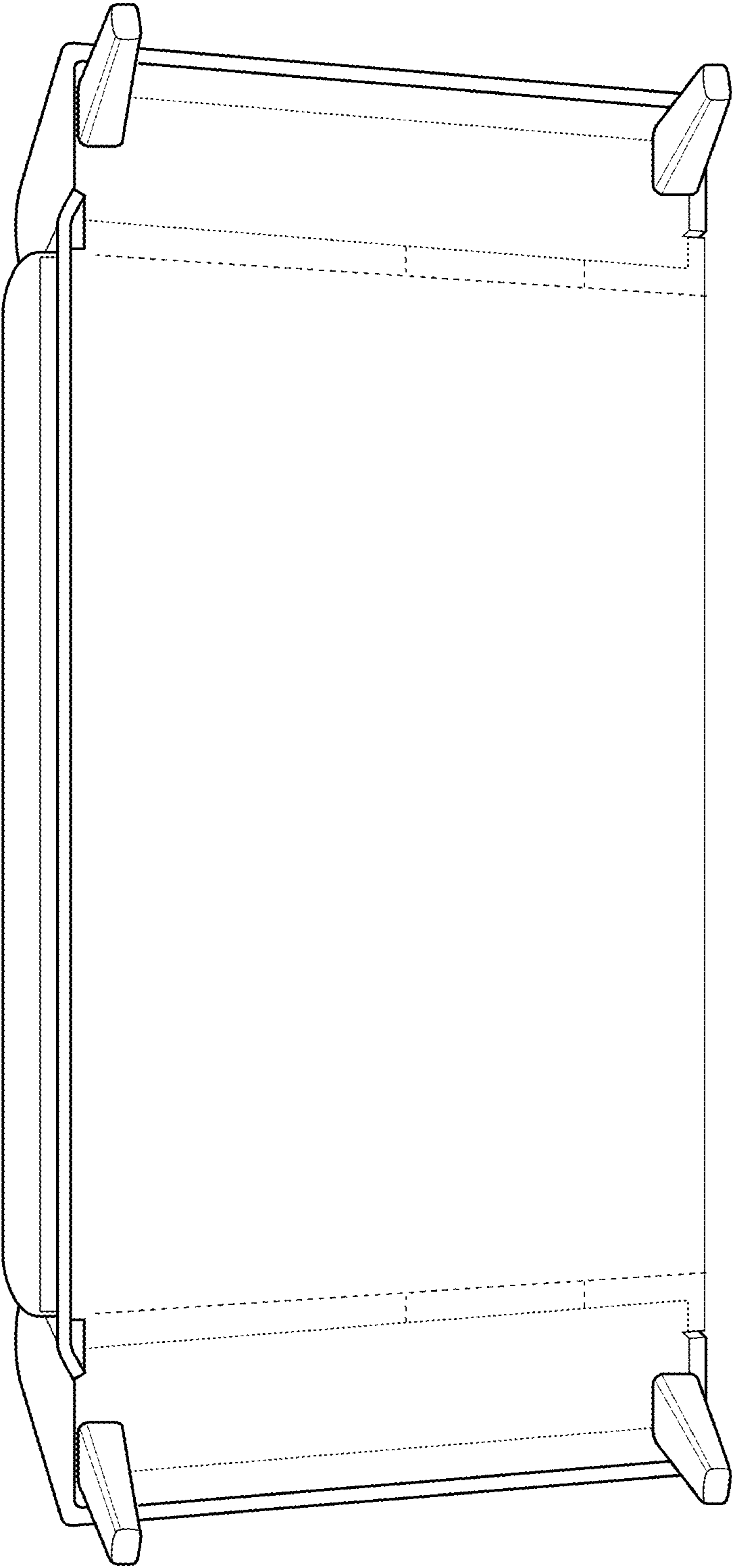

FIG. 14

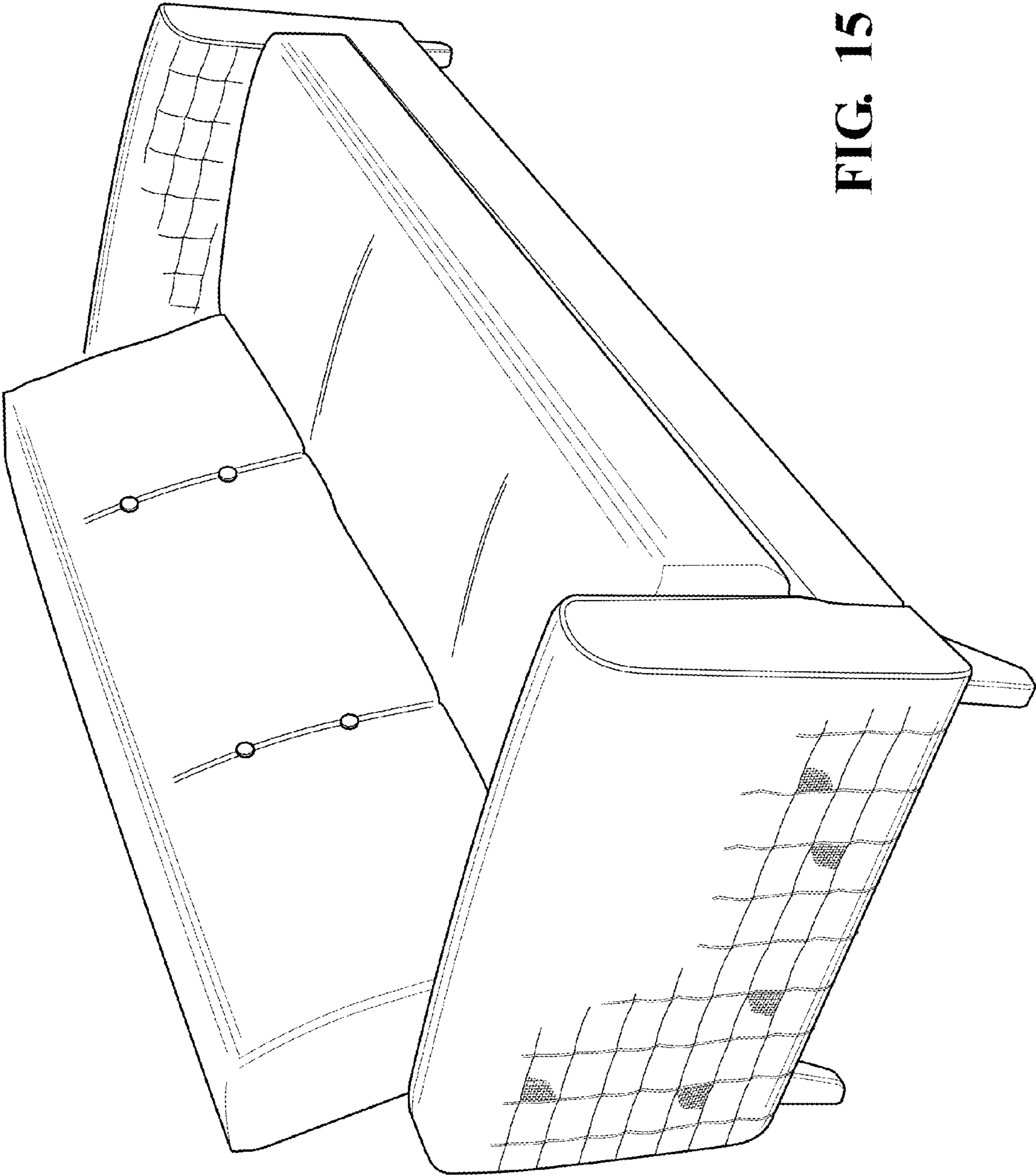

FIG. 15

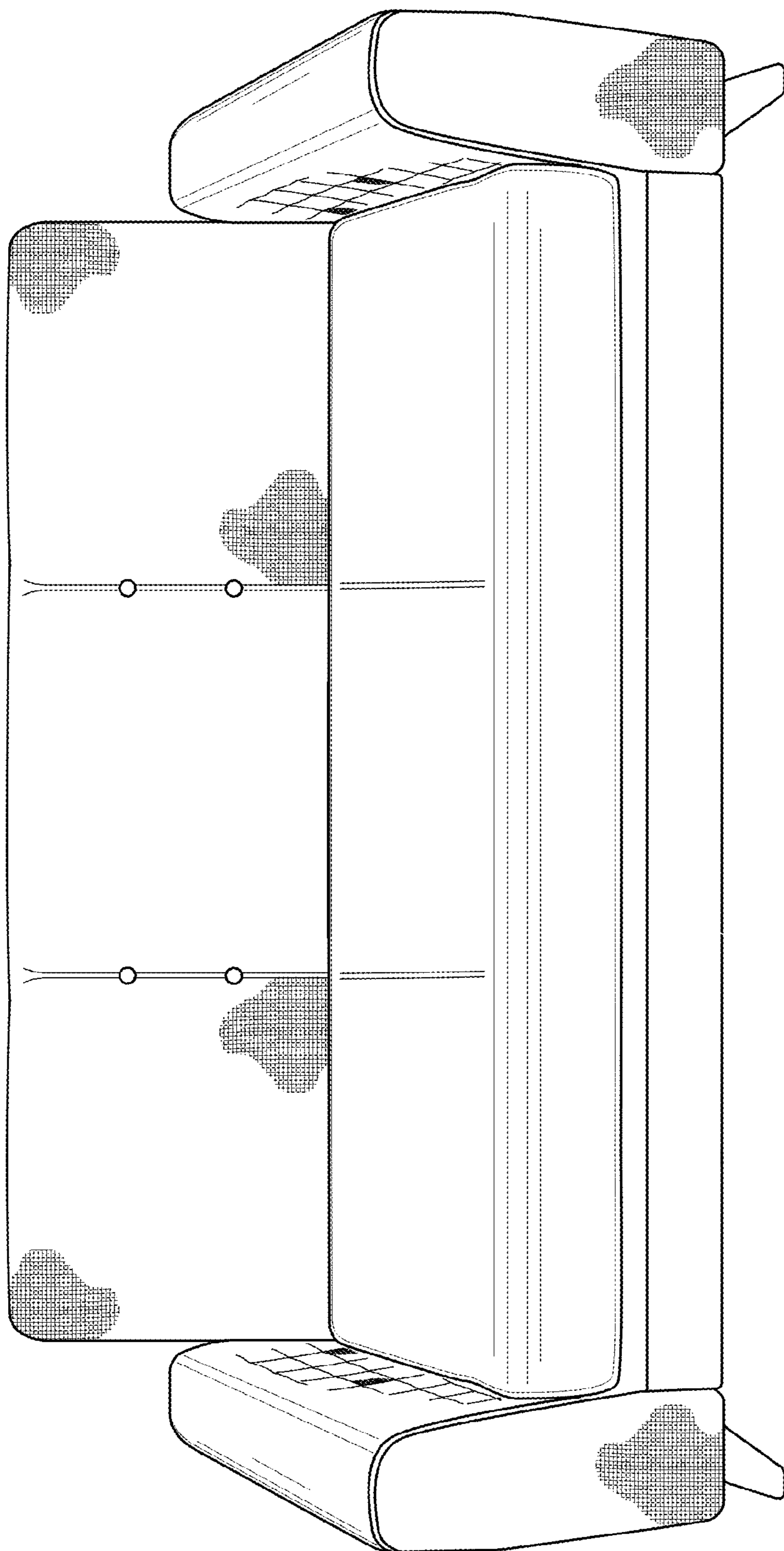

FIG. 16

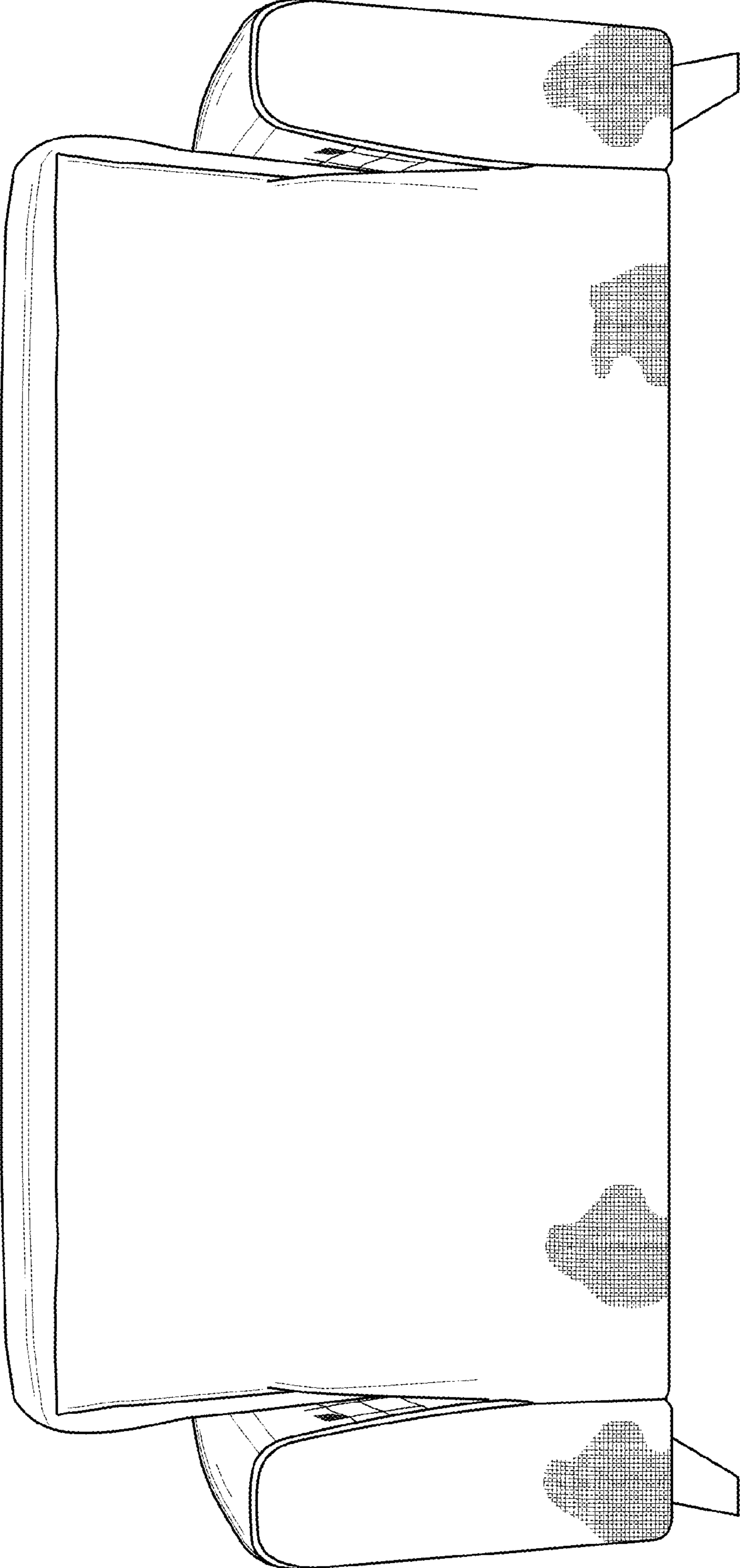

FIG. 17

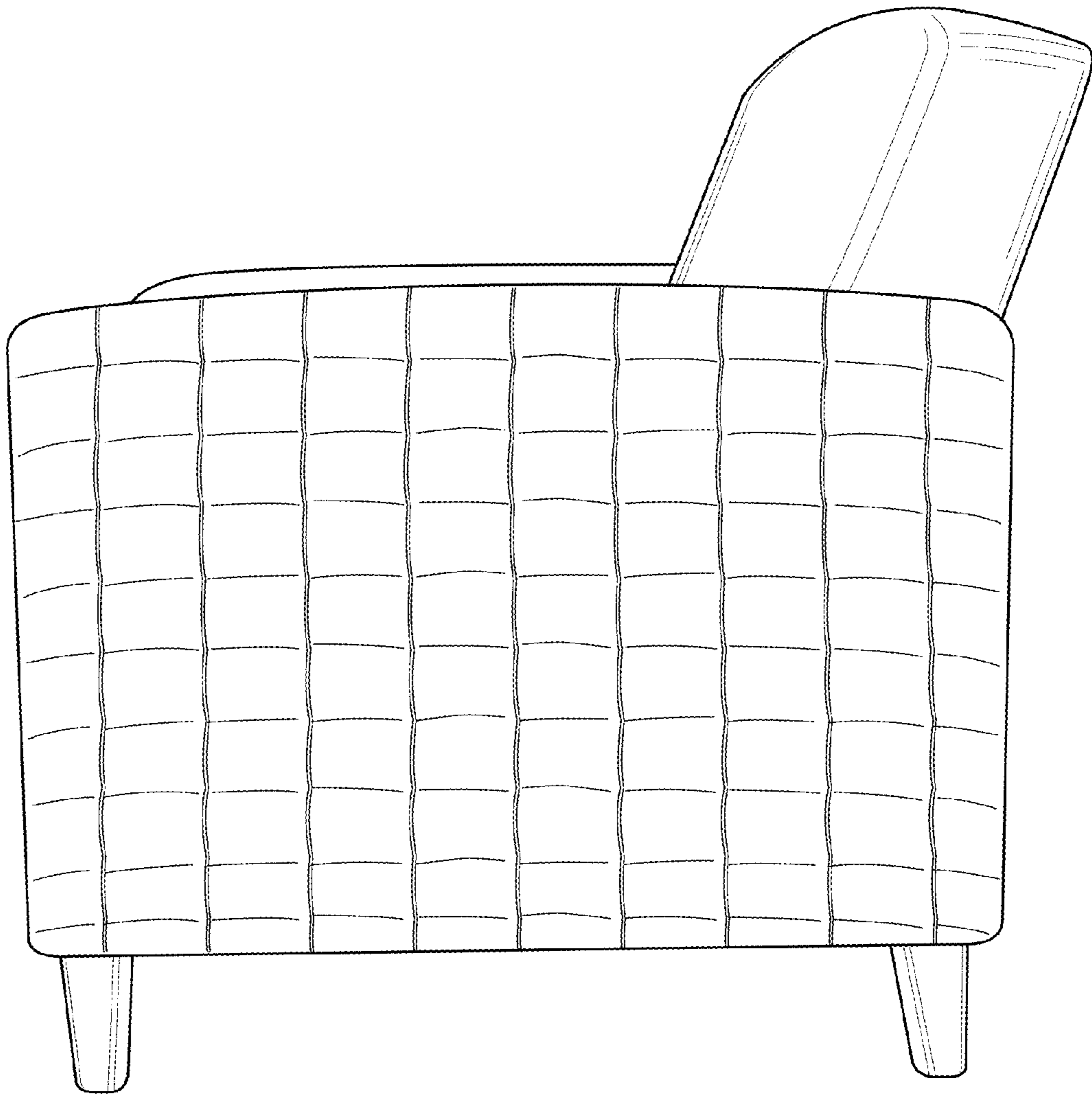

FIG. 18

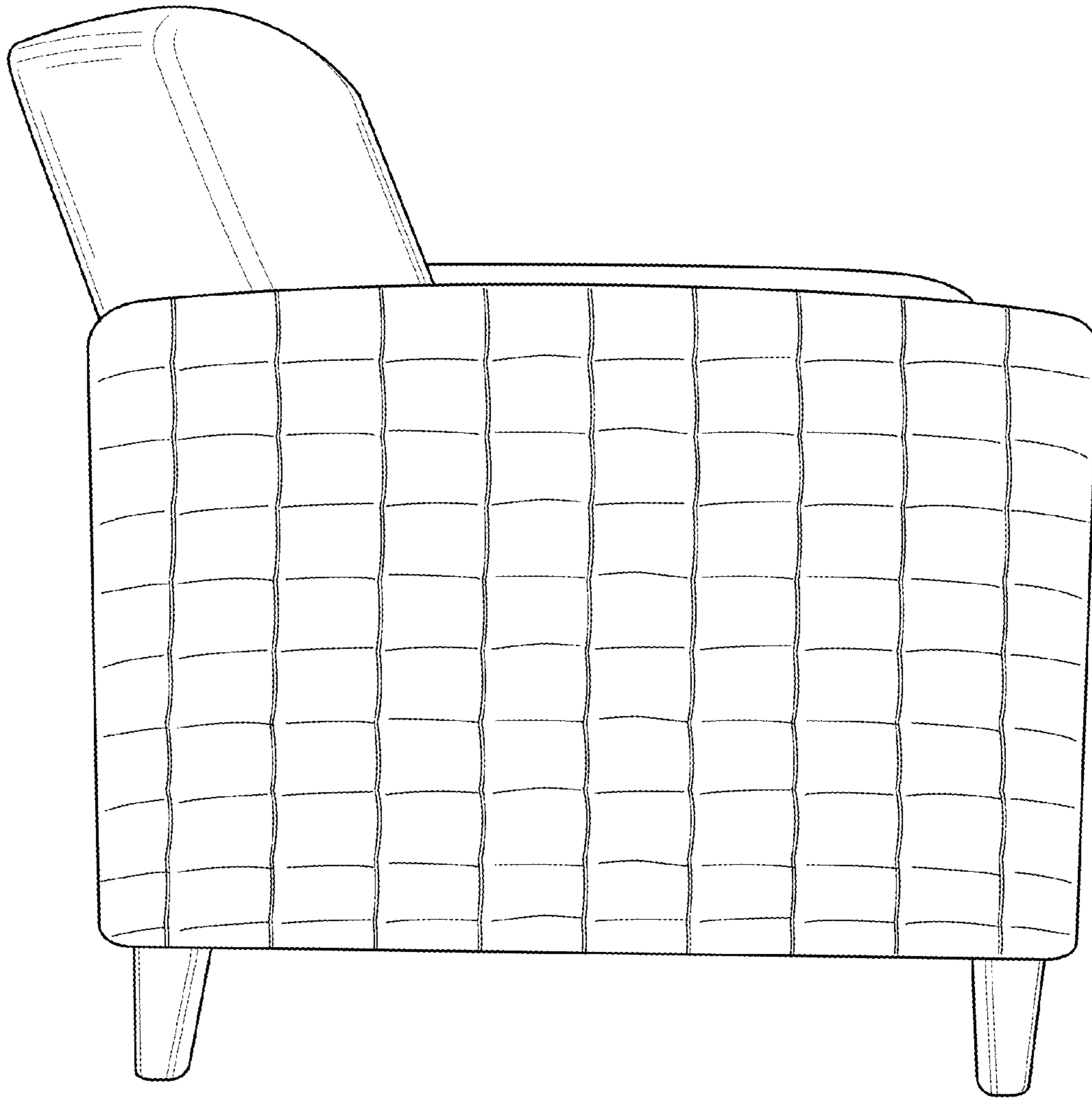

FIG. 19

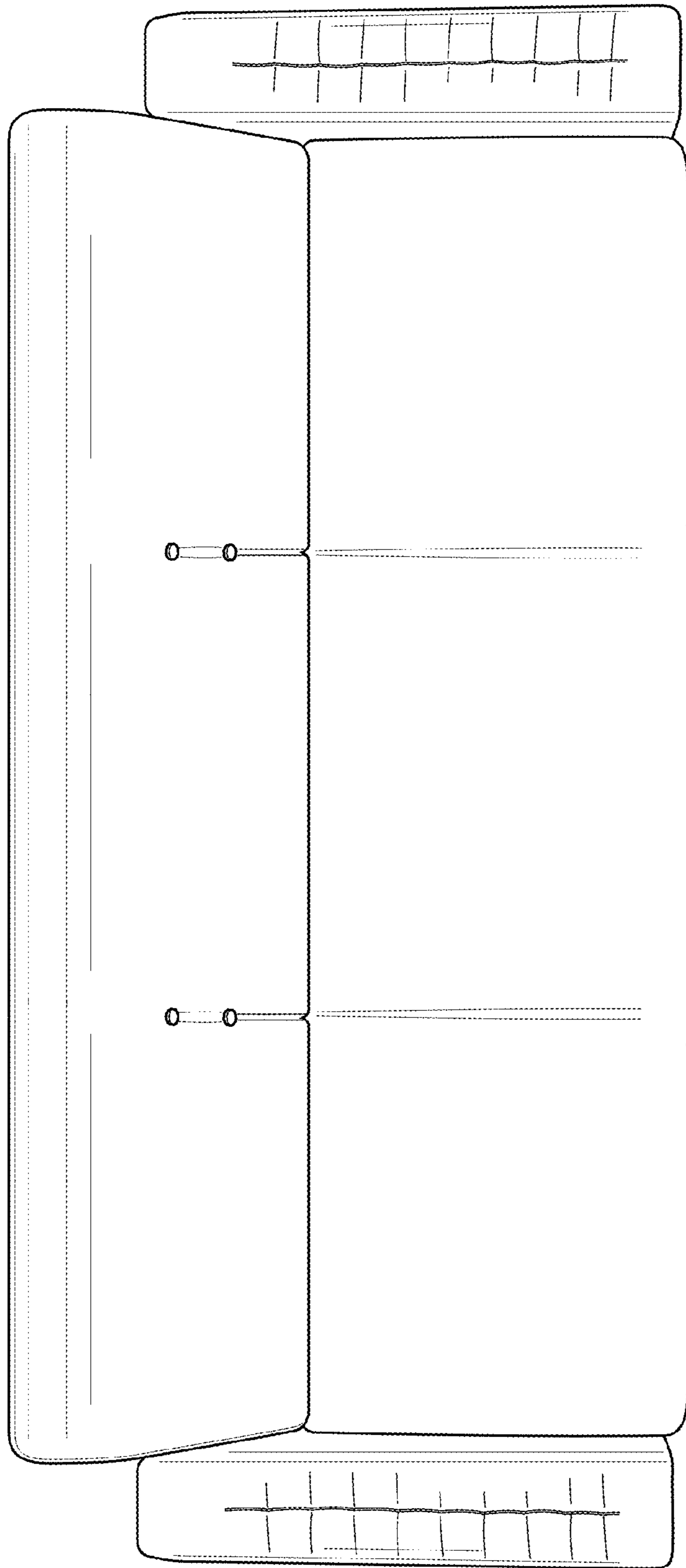

FIG. 20

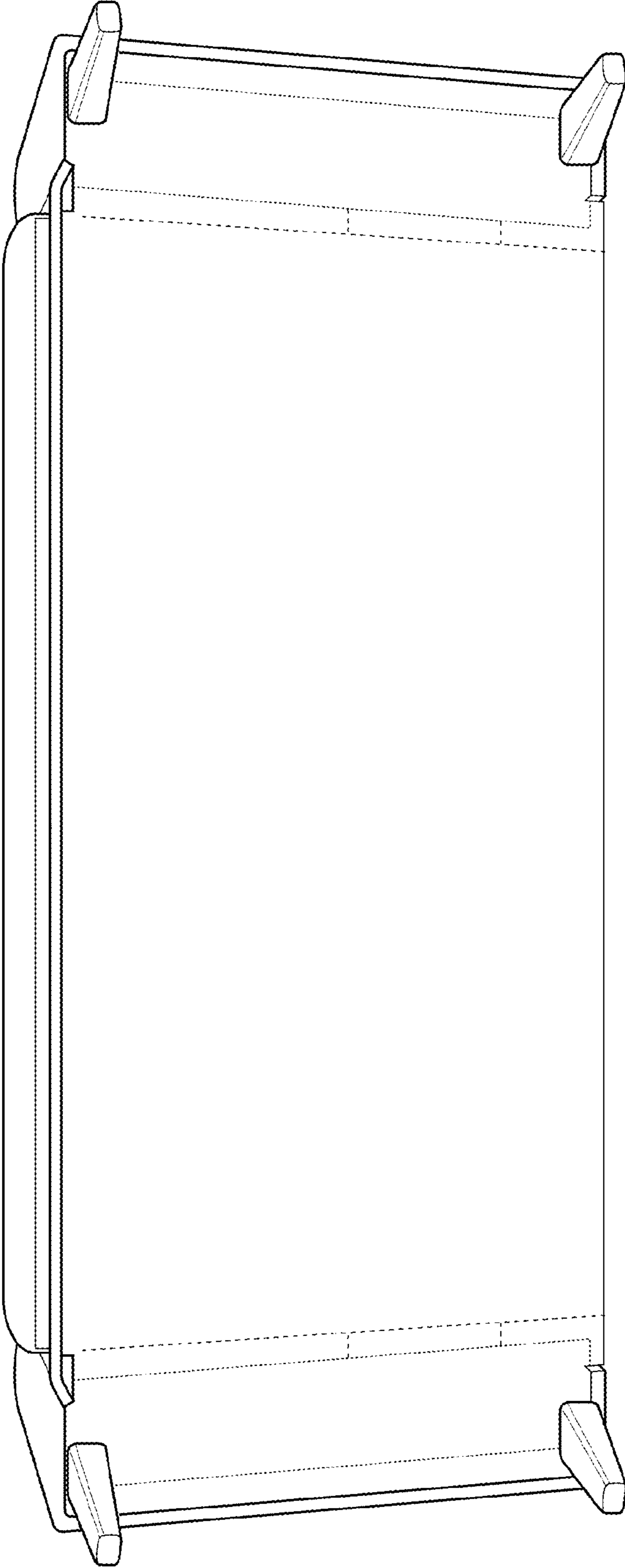

FIG. 21