



US00D737002S

(12) **United States Design Patent**
Olson

(10) **Patent No.:** **US D737,002 S**

(45) **Date of Patent:** **** Aug. 18, 2015**

(54) **SHOOTING BROW PROTECTOR**

(71) Applicant: **Eldred E. Olson**, Clarkston, WA (US)

(72) Inventor: **Eldred E. Olson**, Clarkston, WA (US)

(**) Term: **14 Years**

(21) Appl. No.: **29/447,745**

(22) Filed: **Mar. 6, 2013**

(51) **LOC (10) Cl.** **29-02**

(52) **U.S. Cl.**

USPC **D29/108**

(58) **Field of Classification Search**

USPC D29/100, 102, 105, 106, 108, 109,
D29/120.1, 122; D28/10, 41; 2/455, 456,
2/410, 411, 417, 418, 419, 424, 425, 15,
2/9, 171, 206, 207, 918
CPC A42B 3/18; A42B 3/20; A42B 3/00;
A42B 5/00; A41D 20/00; A41D 20/005;
A41D 23/00; A41D 2023/002; A41D
2023/004; A41D 2023/006; A41D 2023/008;
A41D 2600/00; A41D 2600/10; A63B 71/08;
A61F 13/00008; A61F 2013/00497; A61F
2013/00502

See application file for complete search history.

(56) **References Cited**

U.S. PATENT DOCUMENTS

3,131,400 A * 5/1964 Blanchard et al. 2/68
D210,181 S * 2/1968 Solomon D28/44.2
D270,014 S * 8/1983 Lutzker D29/108
4,481,680 A * 11/1984 Mason et al. 2/174
D377,241 S * 1/1997 Kenner D29/108
D435,699 S * 12/2000 Mowry D29/102
6,438,761 B1 * 8/2002 McGarrity 2/410
D519,716 S * 5/2006 Smith D2/875

D605,816 S * 12/2009 Holden et al. D29/108
D654,250 S * 2/2012 Kaufman D2/876
D656,683 S * 3/2012 Capasso D29/109

* cited by examiner

Primary Examiner — Elizabeth J Oswecki

(74) *Attorney, Agent, or Firm* — Heisler & Associates

(57) **CLAIM**

The ornamental design for a shooting brow protector, as shown and described.

DESCRIPTION

FIG. 1 is a perspective view of a first embodiment of a shooting brow protector showing my new design; FIG. 2 is a top plan view thereof, the bottom plan view being a mirror image; FIG. 3 is a front elevation view thereof; FIG. 4 is a left side view thereof, the right side view being a mirror image; FIG. 5 is a rear elevation view thereof; FIG. 6 is another perspective view thereof with the elastic band portion shown in a stretched position; FIG. 7 is a perspective view thereof shown in a used condition; FIG. 8 is a perspective view of a second embodiment of a shooting brow protector showing my new design; FIG. 9 is a top plan view thereof, the bottom plan view being a mirror image; FIG. 10 is a front elevation view thereof; FIG. 11 is a left side view thereof; FIG. 12 is a rear elevation view thereof; FIG. 13 is a right side view thereof; and, FIG. 14 is a perspective view thereof with the adjustable band portion shown in an open position.

The broken lines shown on the shooting brow protector represent thread stitching. The broken lines illustrating the human figure in FIG. 7 form no part of the claimed design.

1 Claim, 3 Drawing Sheets

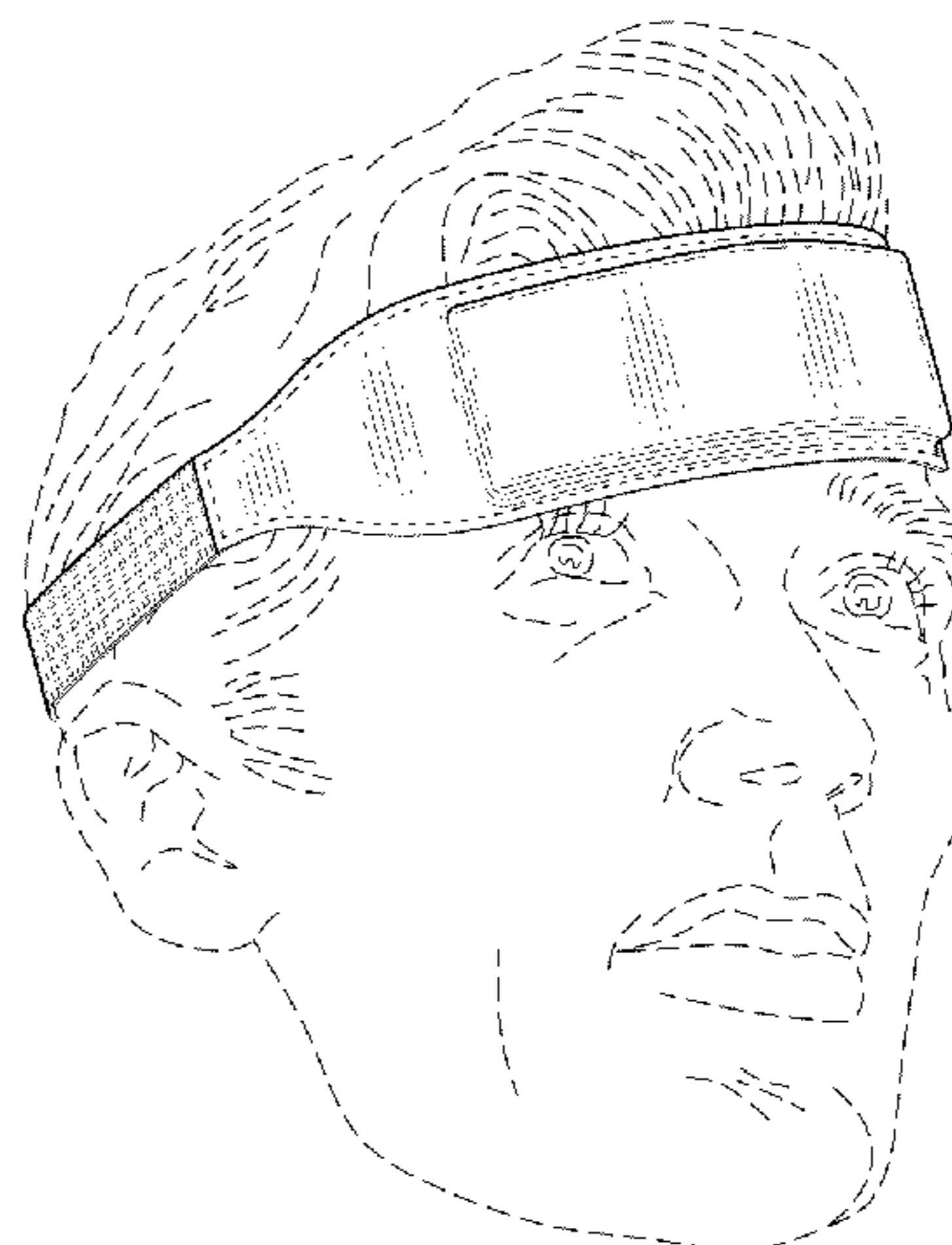
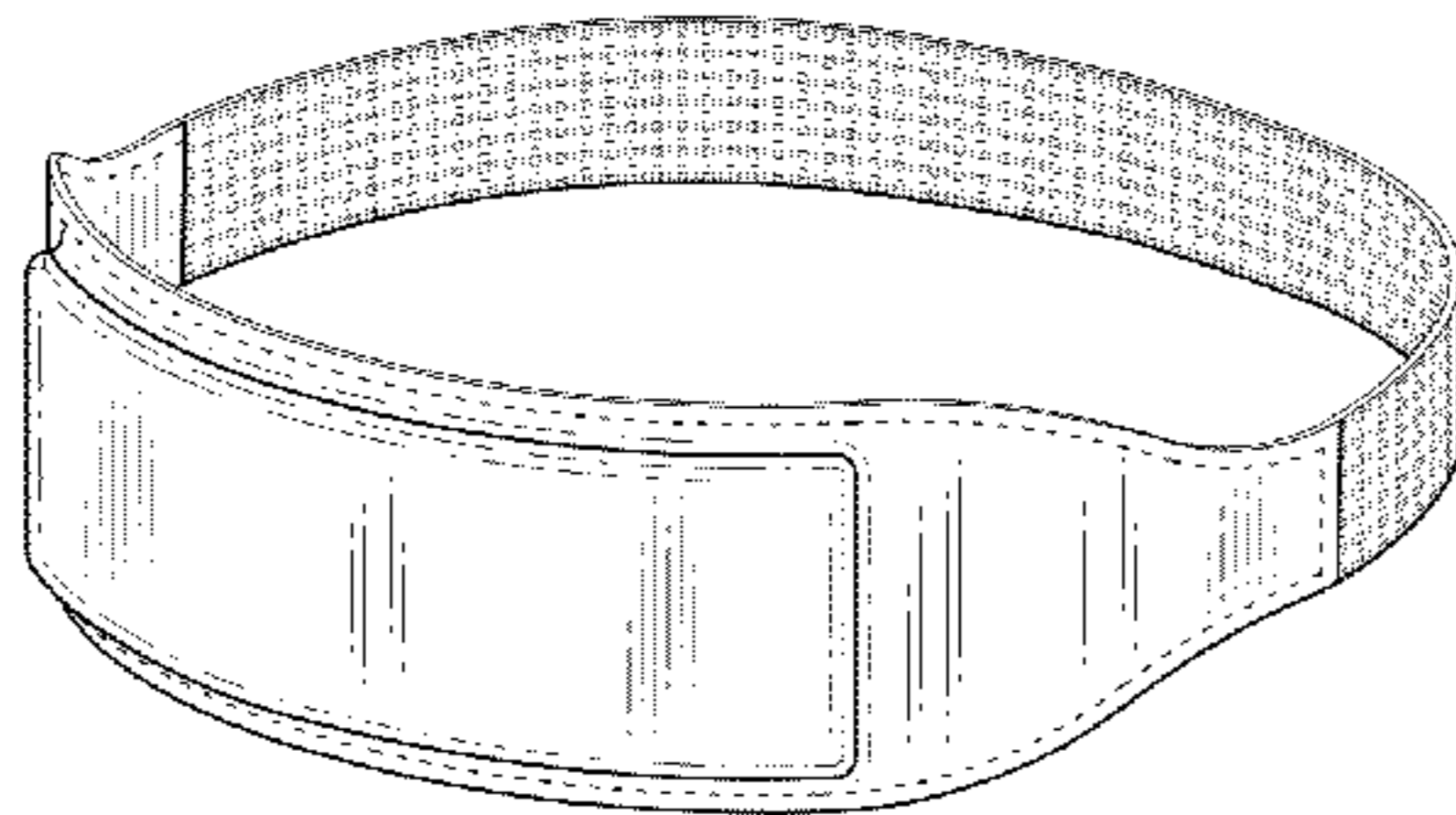

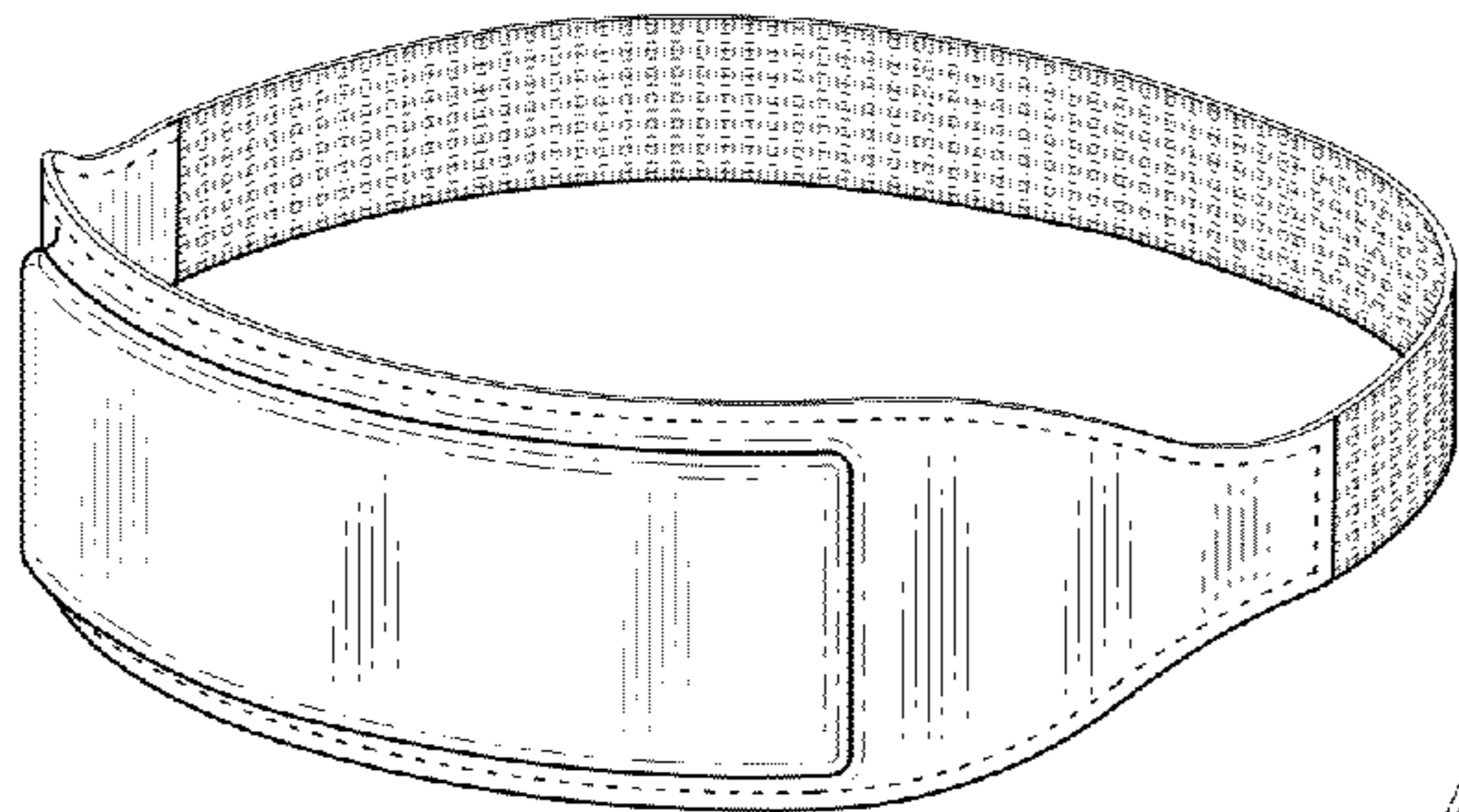

Fig. 1

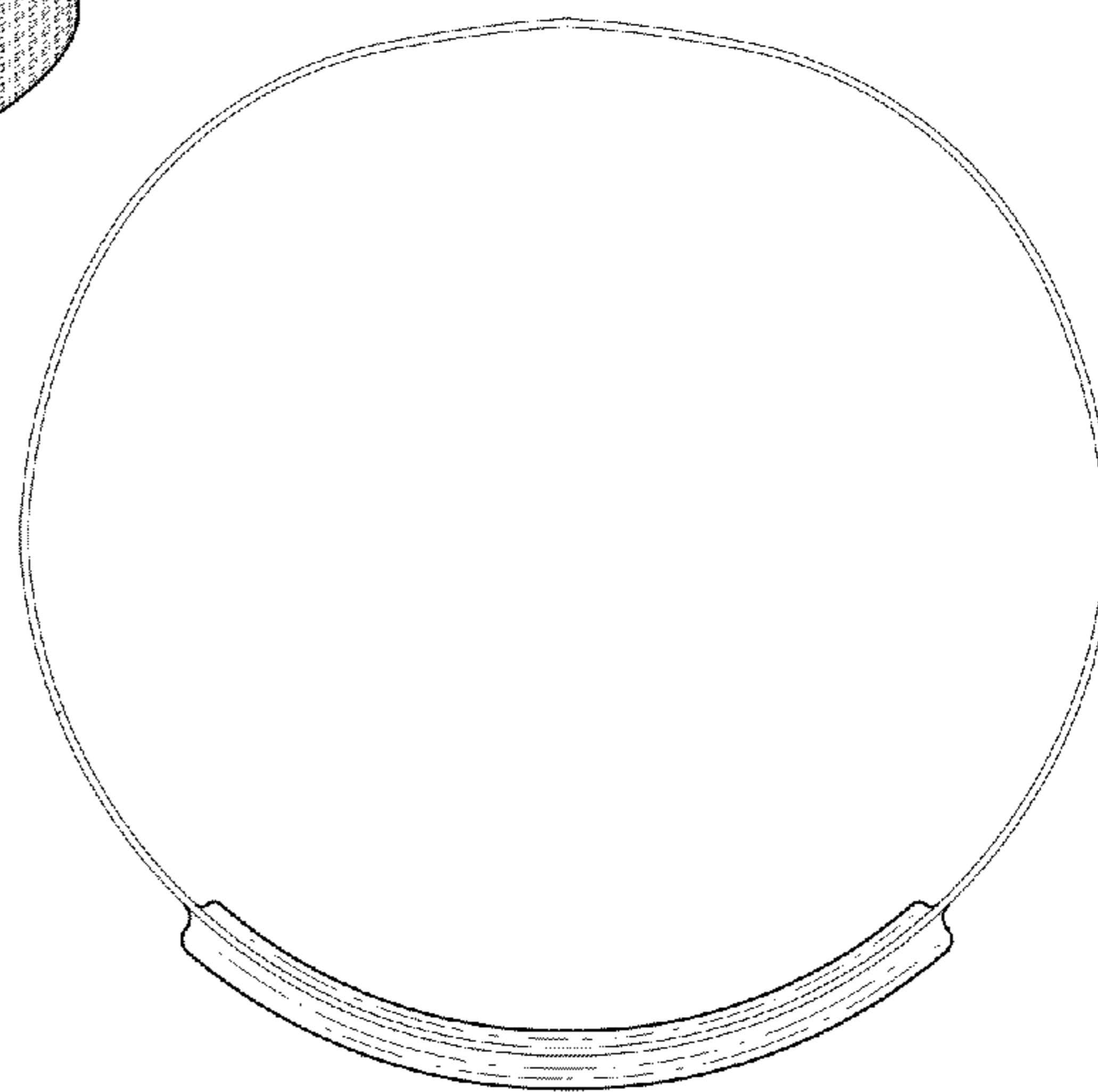

Fig. 2

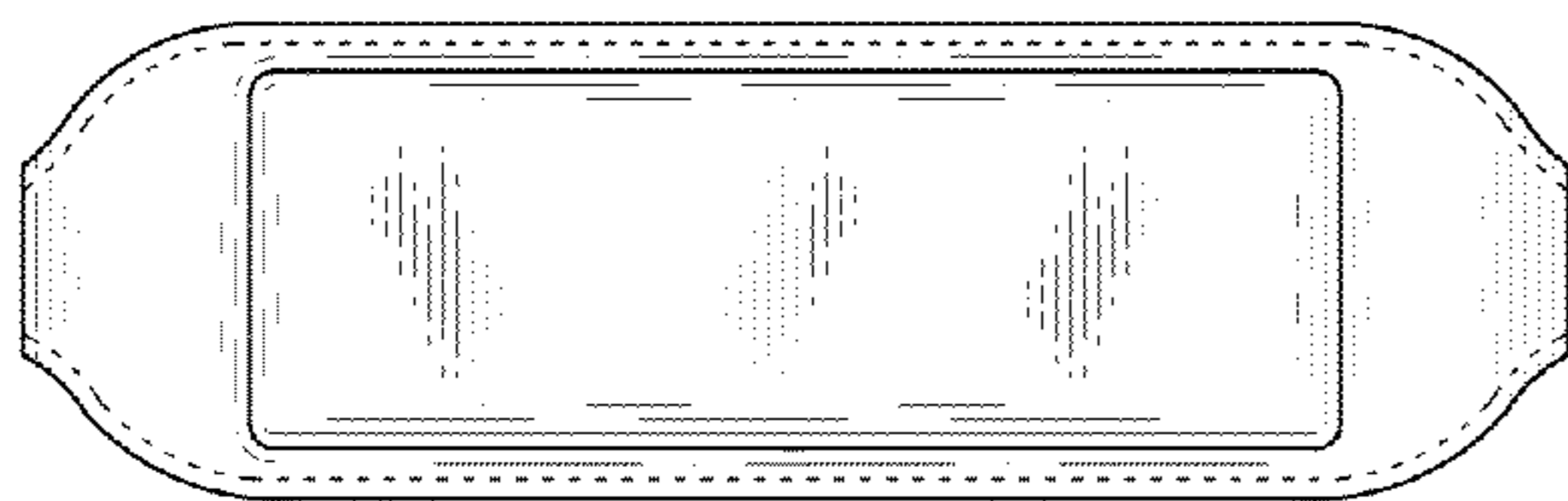

Fig. 3

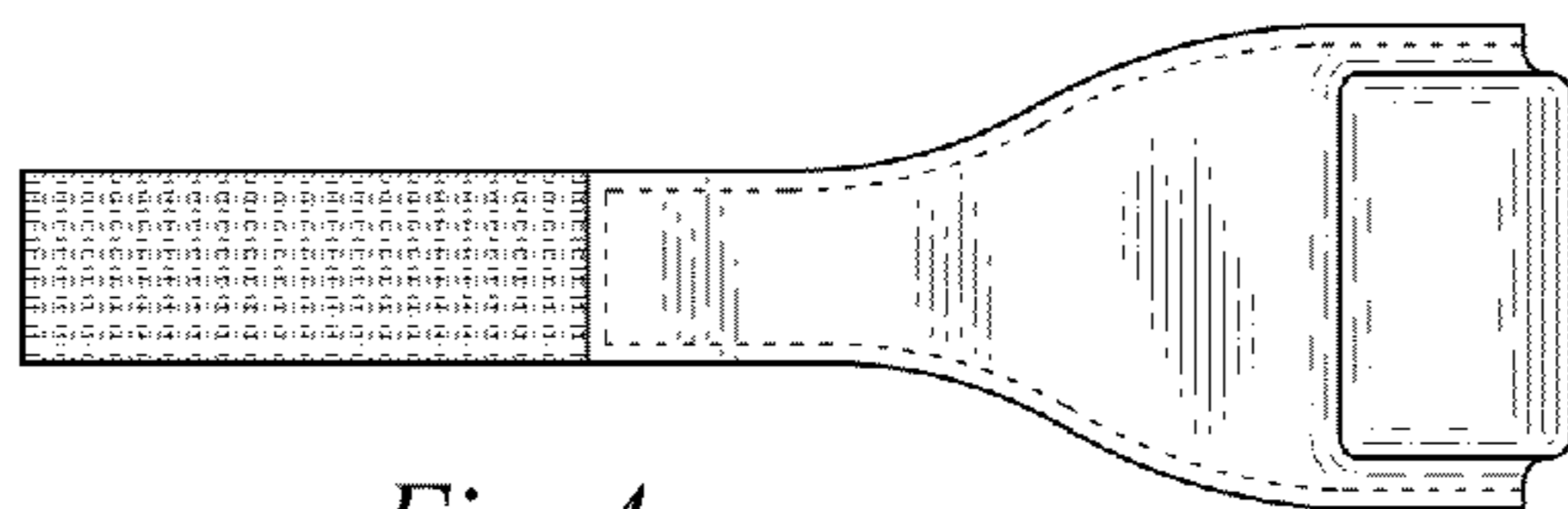

Fig. 4

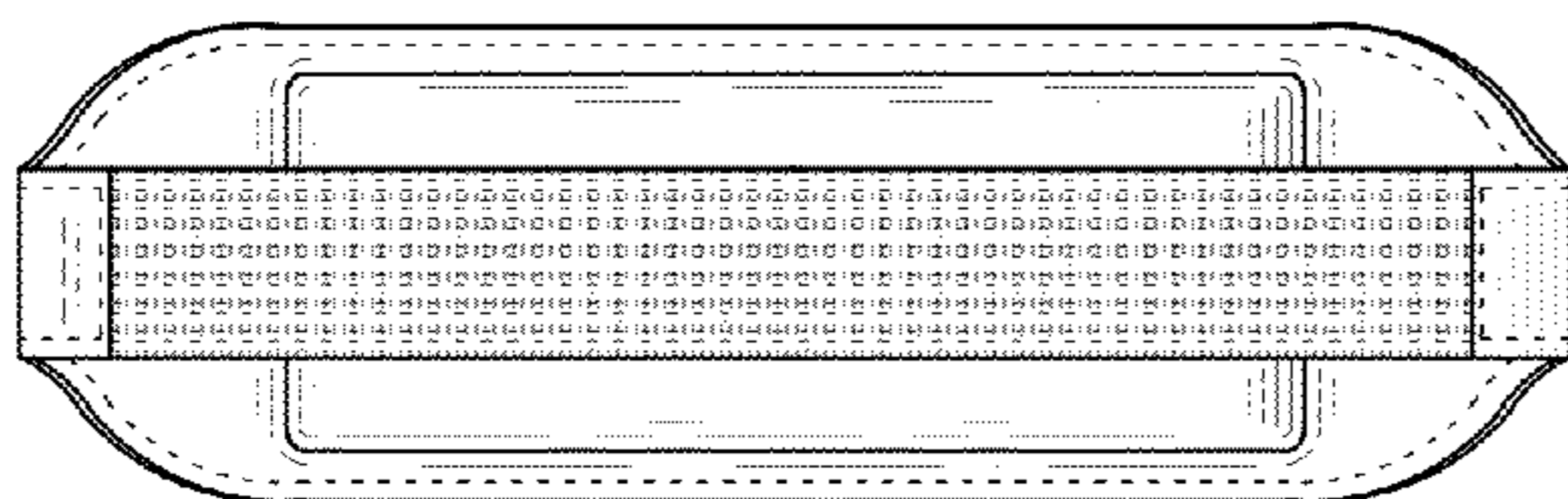

Fig. 5

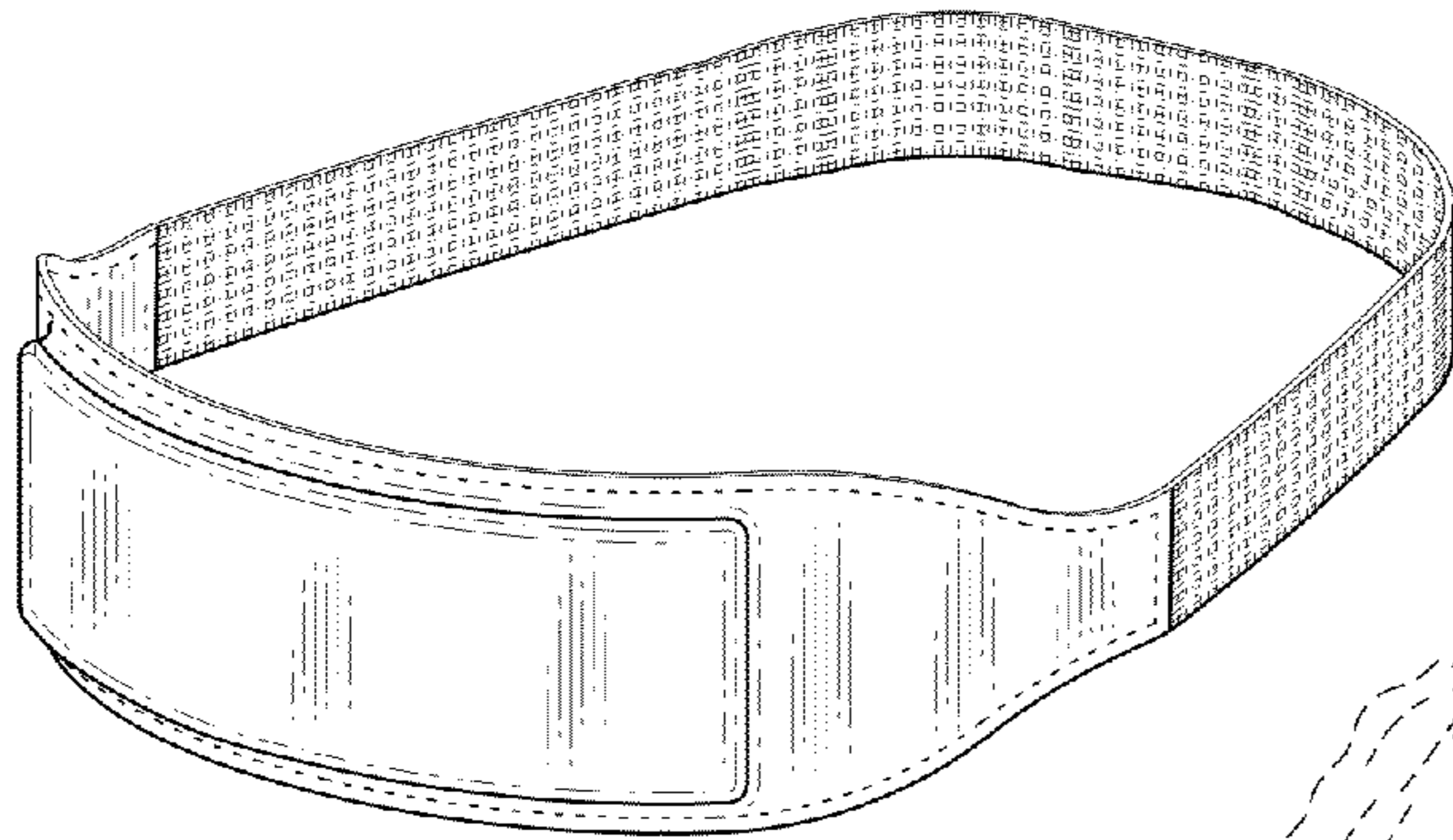

Fig. 6

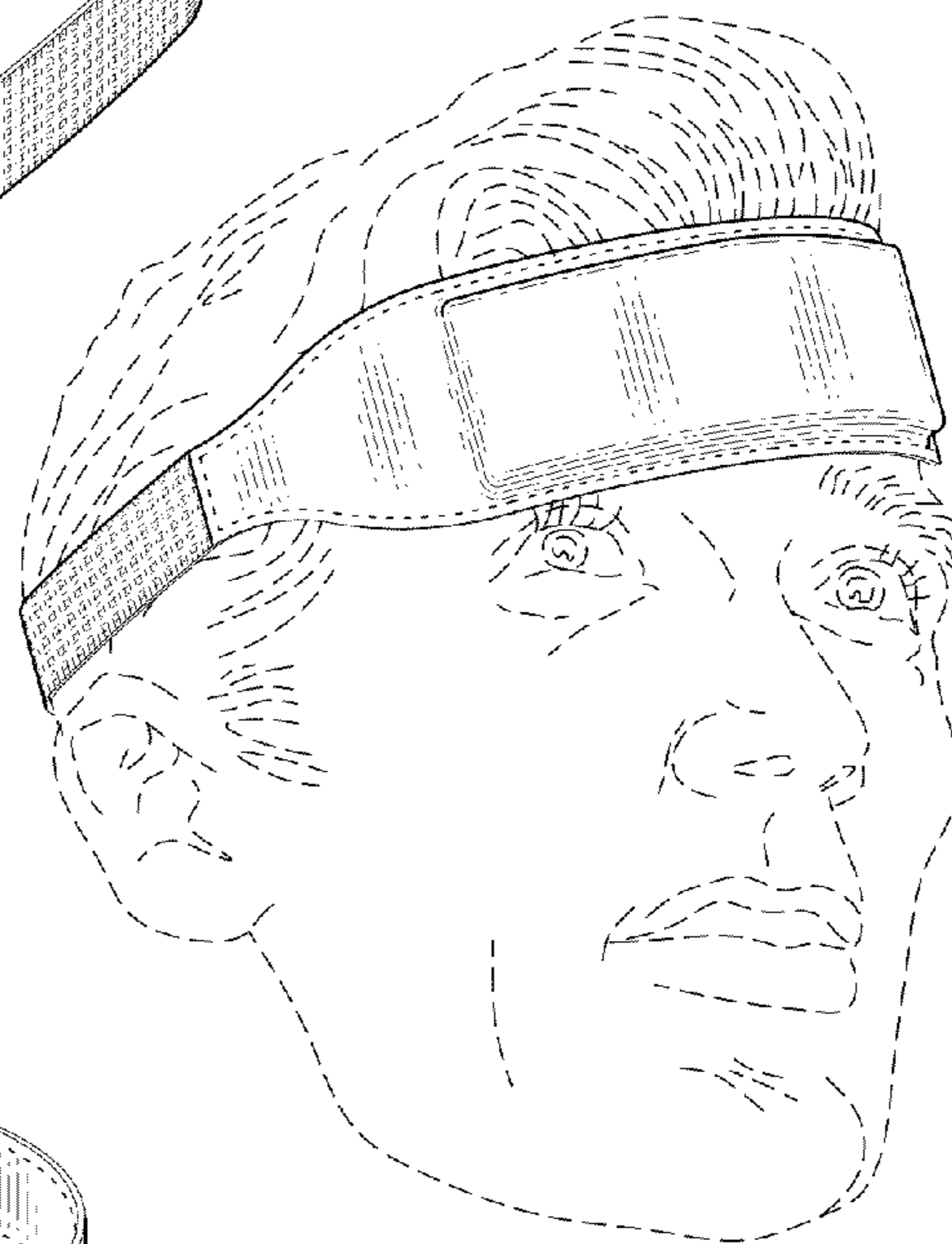

Fig. 7

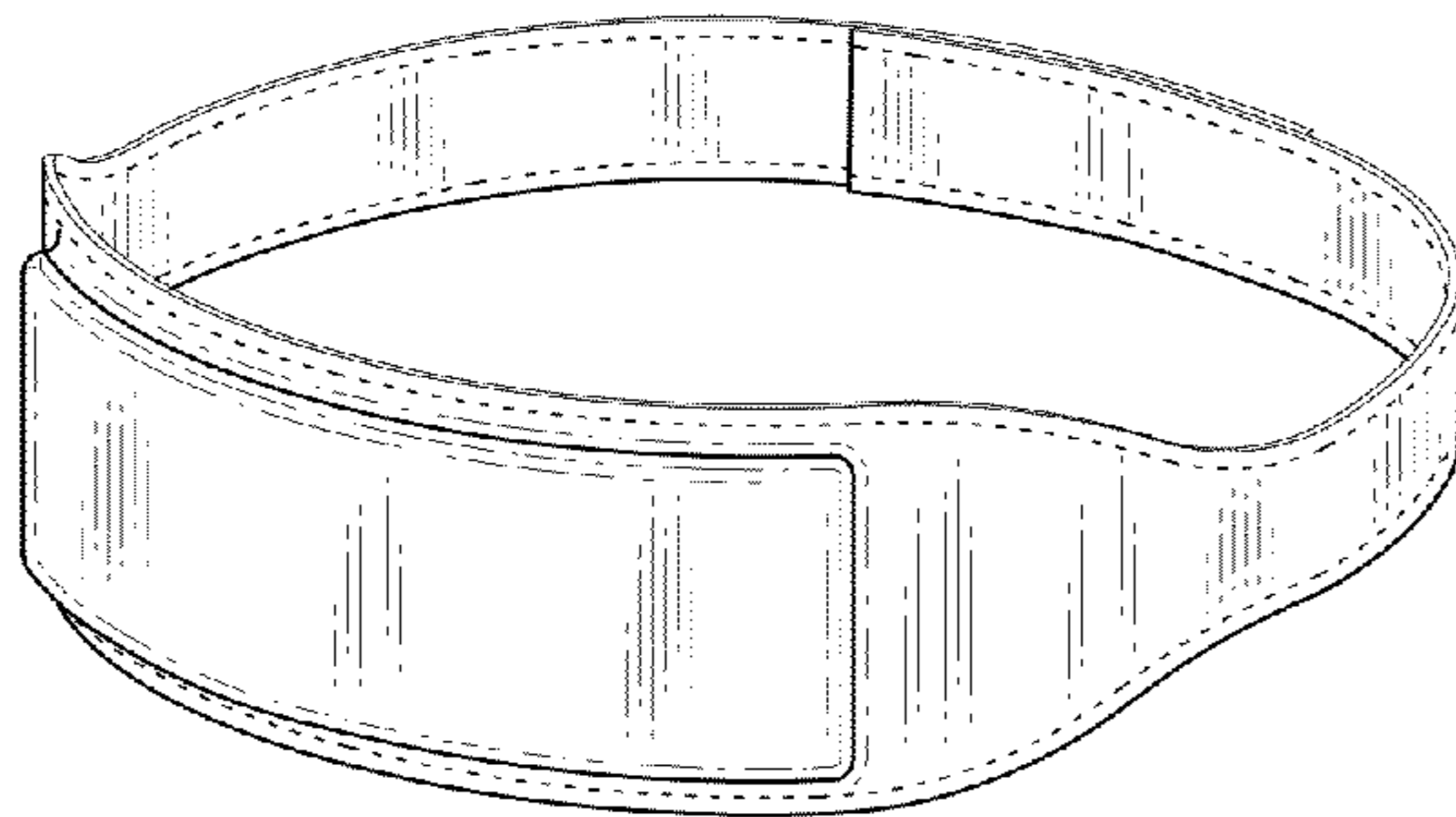

Fig. 8

Fig. 9

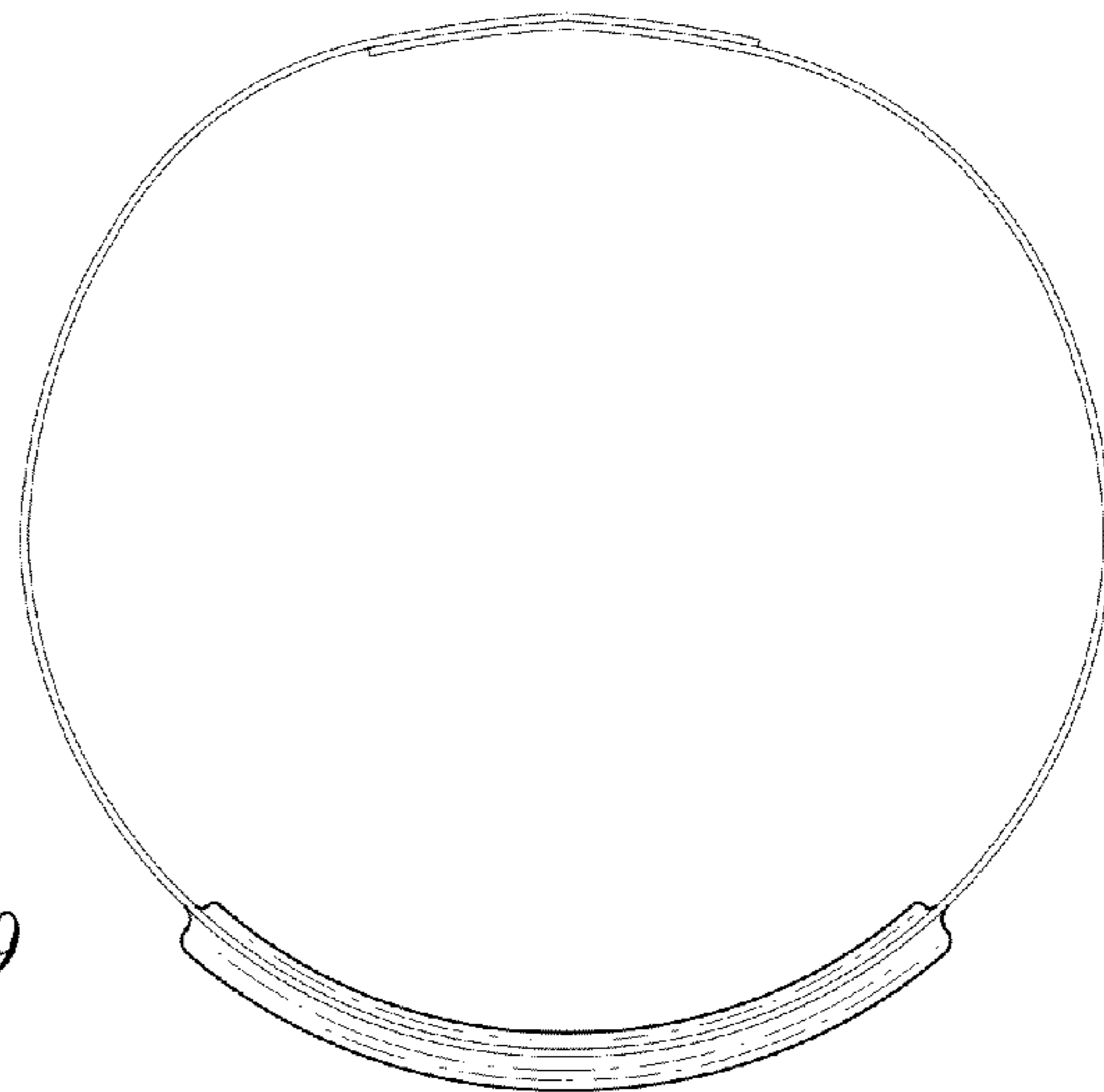

Fig. 10

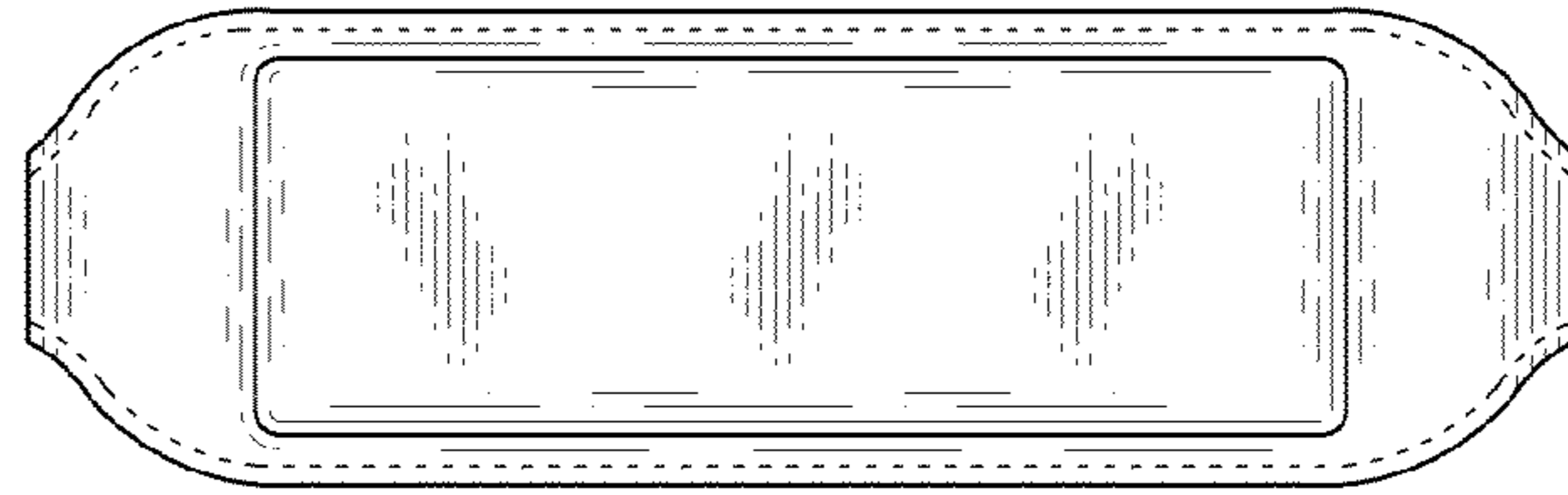

Fig. 11

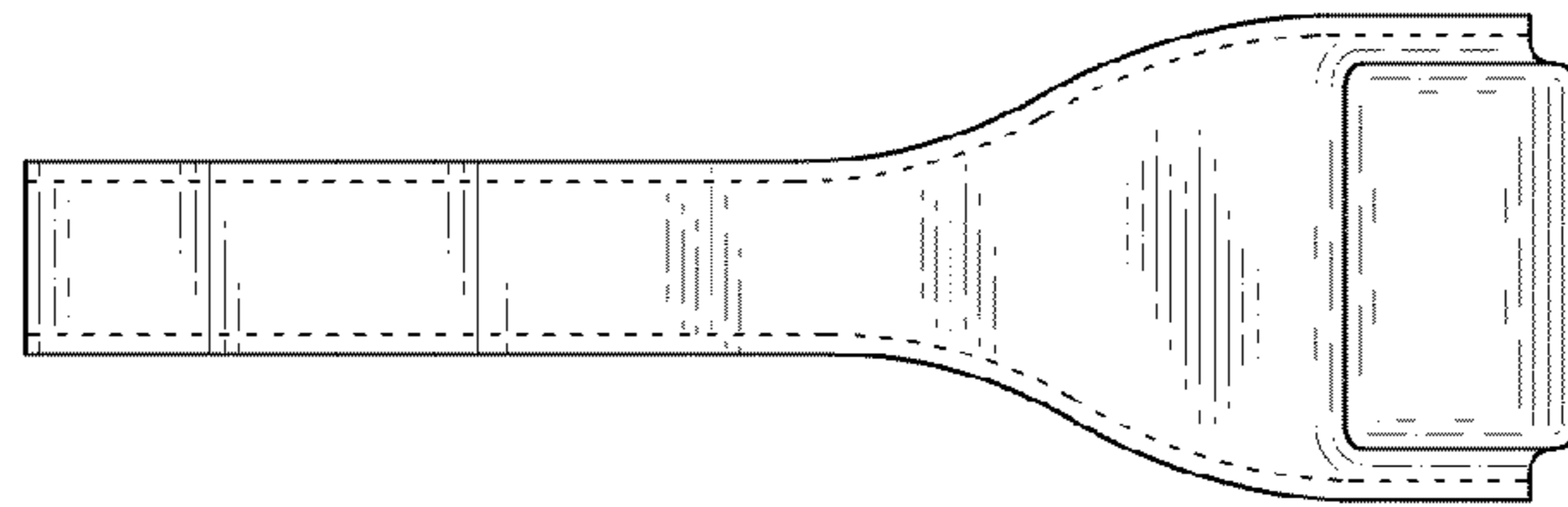

Fig. 12

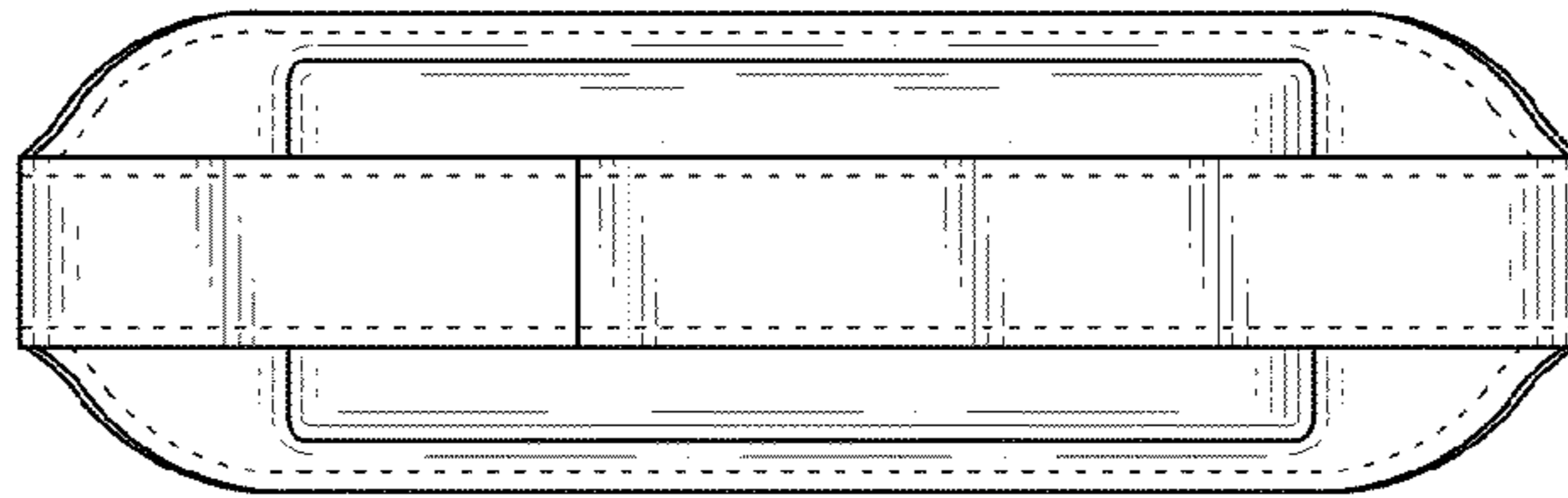

Fig. 13

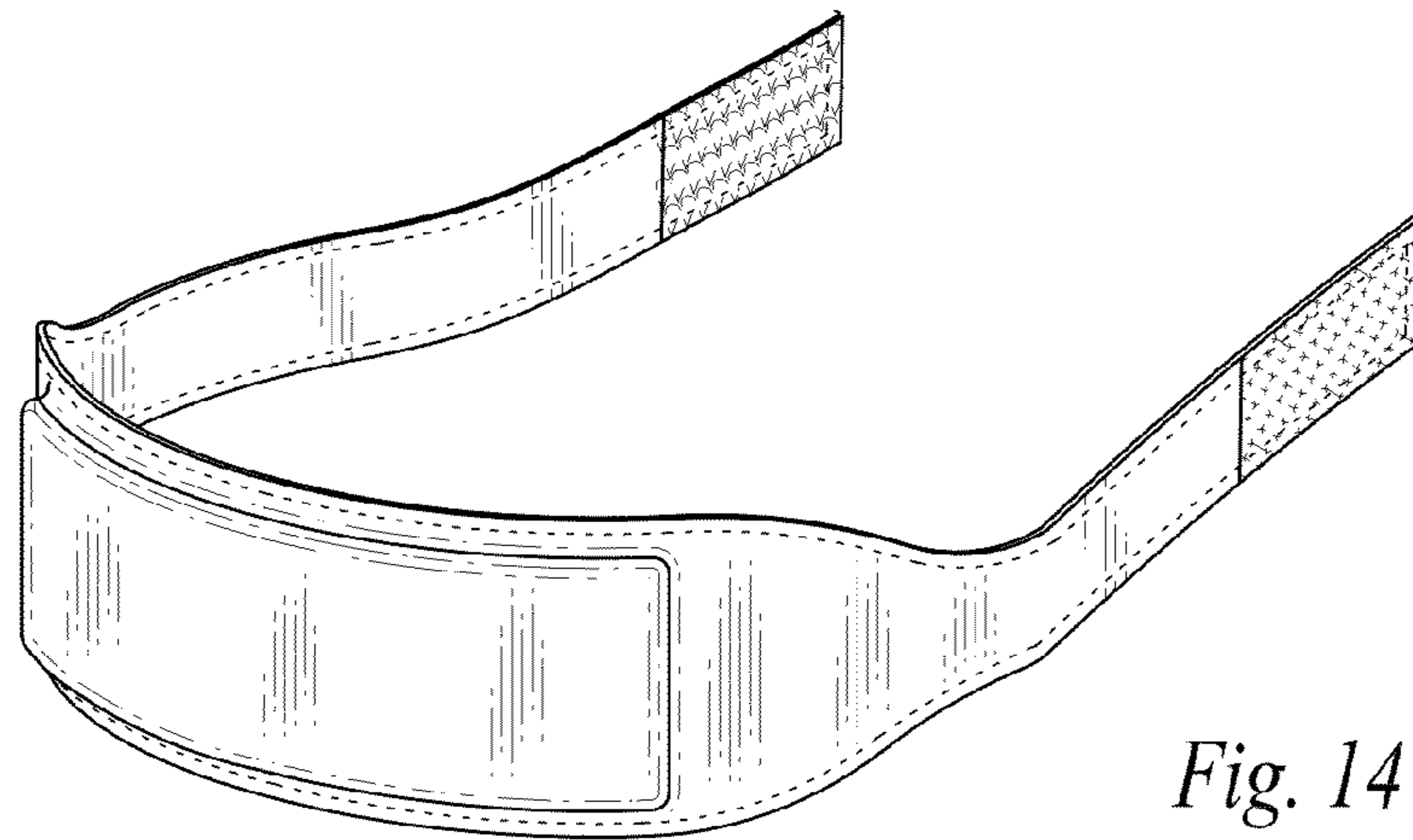
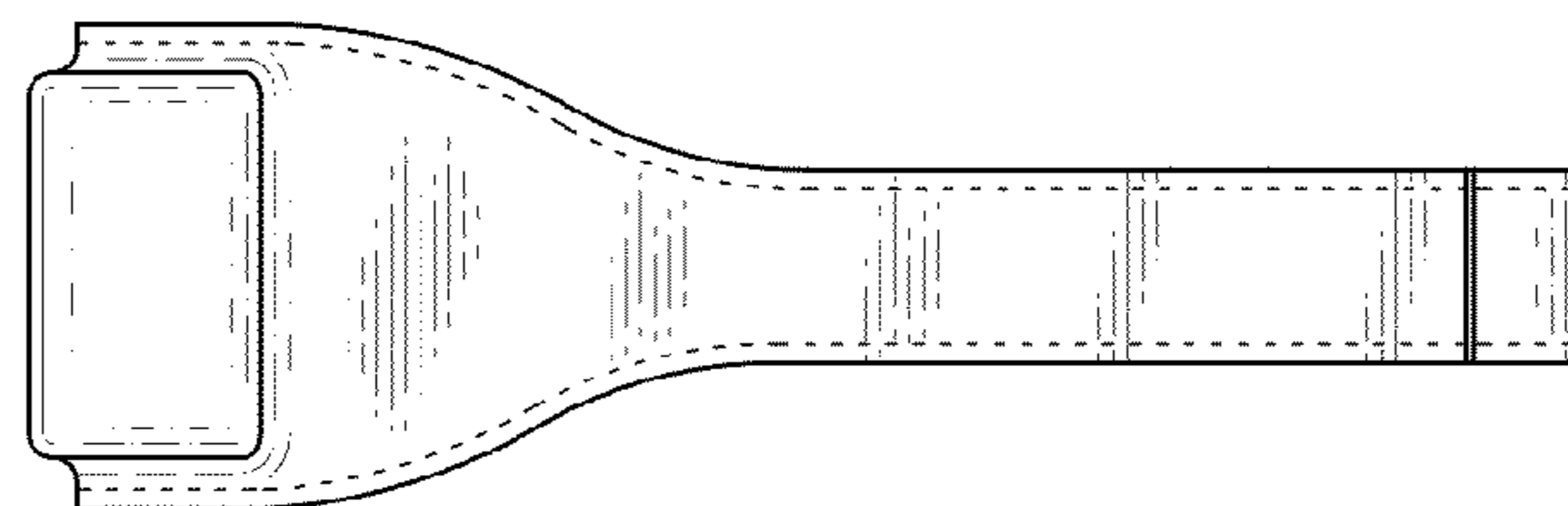

Fig. 14