

US00D736891S

(12) **United States Design Patent**  
**Morita**

(10) **Patent No.:** **US D736,891 S**

(45) **Date of Patent:** **\*\* Aug. 18, 2015**

(54) **CHECK VALVE**

(71) Applicant: **Kosuke Morita**, Tsukubamirai (JP)

(72) Inventor: **Kosuke Morita**, Tsukubamirai (JP)

(73) Assignee: **SMC Corporation**, Chiyoda-ku, Tokyo (JP)

(\*\*) Term: **14 Years**

(21) Appl. No.: **29/492,151**

(22) Filed: **May 29, 2014**

(30) **Foreign Application Priority Data**

Feb. 14, 2014 (JP) ..... 2014-003009

(51) **LOC (10) Cl.** ..... **23-01**

(52) **U.S. Cl.**  
USPC ..... **D23/233**

(58) **Field of Classification Search**  
USPC ..... D23/233-237, 244-249, 250, 266, 328;  
D15/5, 7; 137/15.04, 15.08, 515, 7,  
137/859, 332, 529, 533.17, 540, 54, 543.17,  
137/512.1, 243.2, 852, 223, 232, 366, 234,  
137/368, 349, 367; 251/322, 333, 129.15  
CPC . F16K 31/0655; F16K 31/06; F16K 31/0658;  
F16K 31/0675

See application file for complete search history.

(56) **References Cited**

U.S. PATENT DOCUMENTS

D273,296	S	*	4/1984	Dilliner	.....	D15/5
D363,702	S	*	10/1995	McFadden	.....	D13/183
D373,365	S	*	9/1996	Schoenmeyr	.....	D15/7
D706,904	S	*	6/2014	Faraon Chaul Huerta	...	D23/233
D716,911	S	*	11/2014	Faraon Chaul Huerta	...	D23/233
D726,874	S	*	4/2015	Wong et al.	.....	D23/233
2011/0303861	A1	*	12/2011	Jones	.....	251/129.15
2014/0001386	A1	*	1/2014	Chuang	.....	251/129.15

\* cited by examiner

*Primary Examiner* — Cynthia Ramirez

(74) *Attorney, Agent, or Firm* — Yokoi & Co., U.S.A.;  
Toshiyuki Yokoi

(57) **CLAIM**

The ornamental design for a check valve, as shown and described.

**DESCRIPTION**

FIG. 1 shows a front view of a check valve showing my new design;  
FIG. 2 shows a rear view thereof;  
FIG. 3 shows a right side view thereof;  
FIG. 4 shows a left side view thereof;  
FIG. 5 shows a top view thereof;  
FIG. 6 shows a bottom view thereof;  
FIG. 7 shows a top, front and right side perspective view thereof; and,  
FIG. 8 shows a bottom, front and left side perspective view thereof.

**1 Claim, 4 Drawing Sheets**

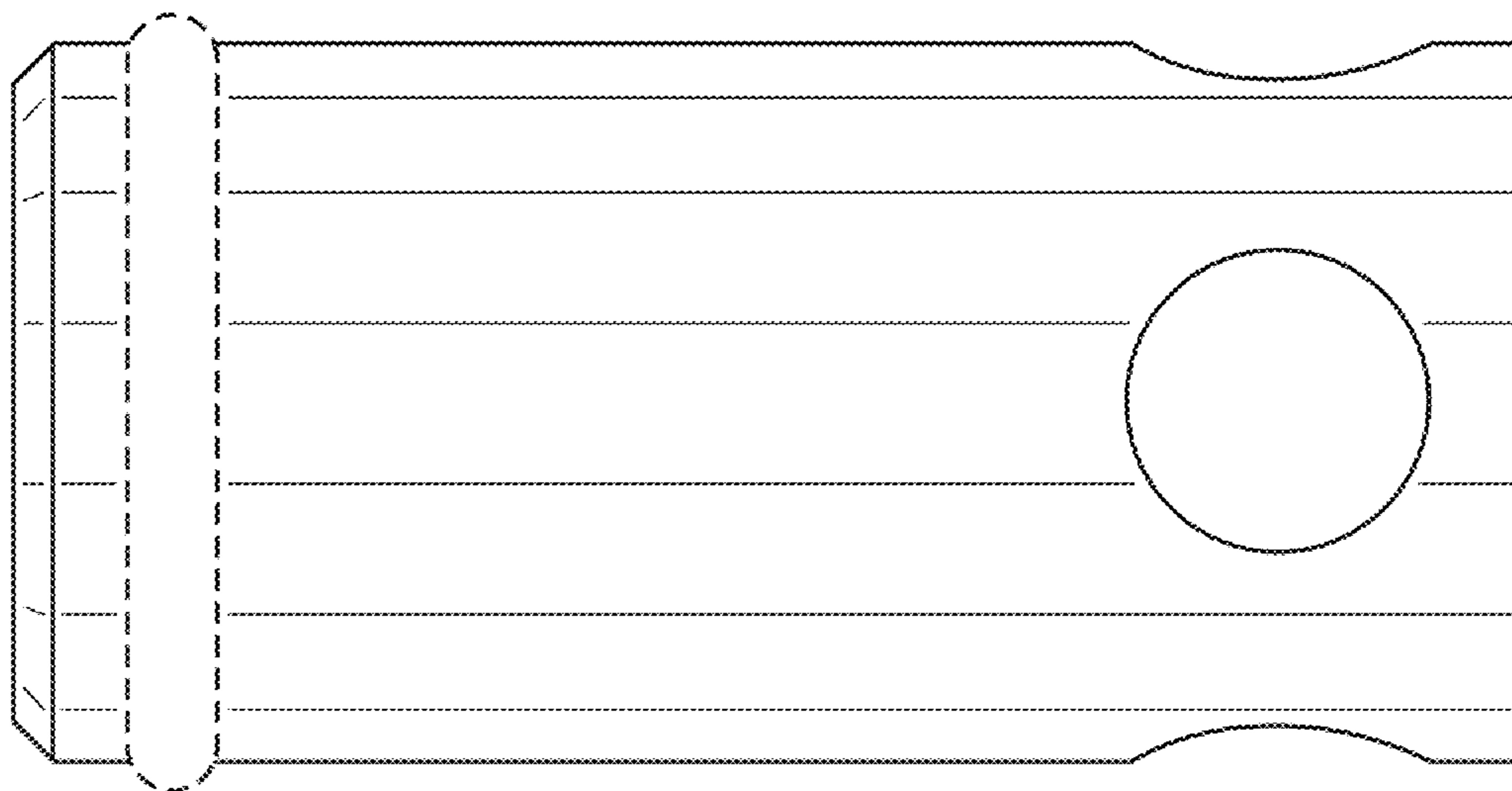

FIG. 1

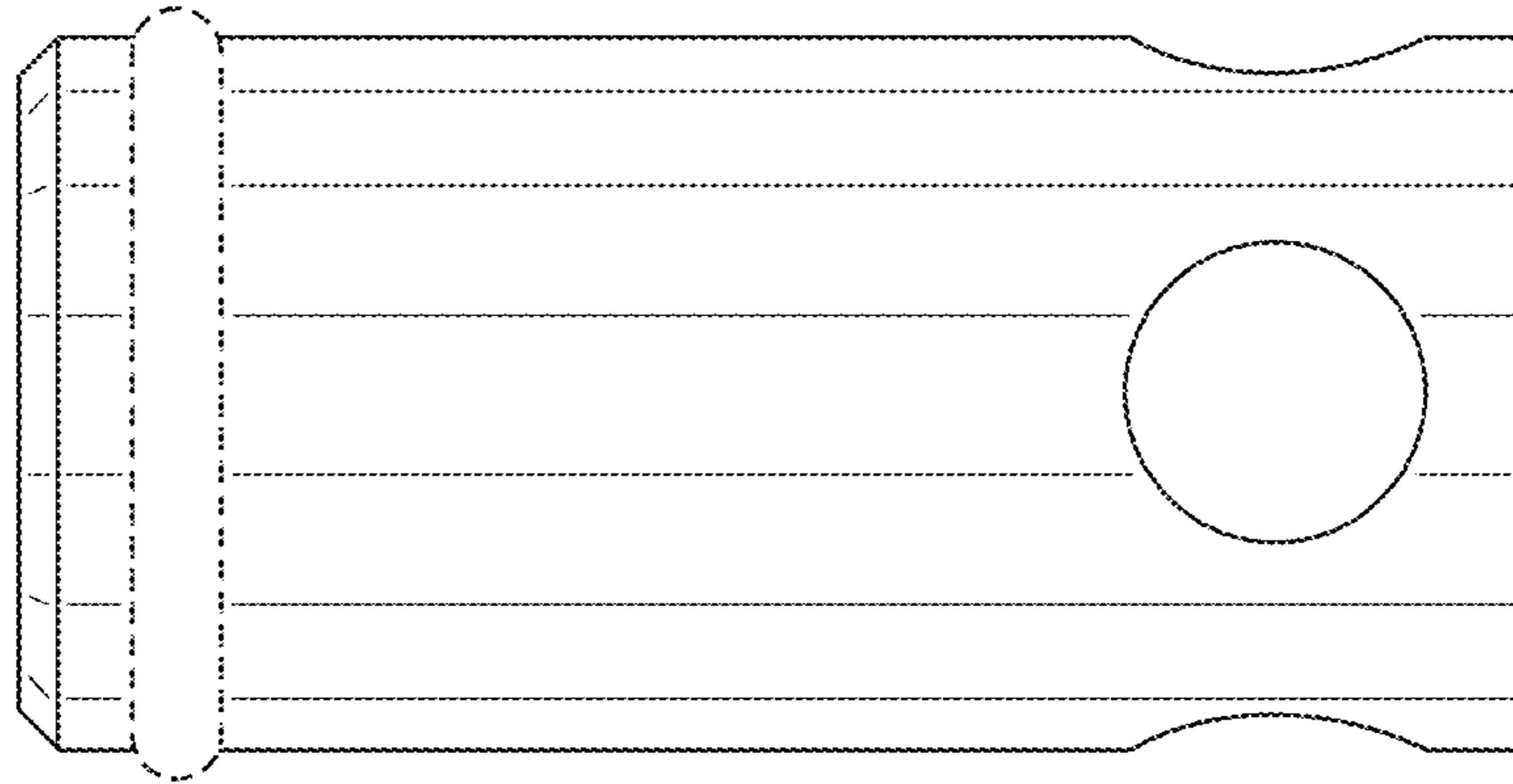

FIG. 2

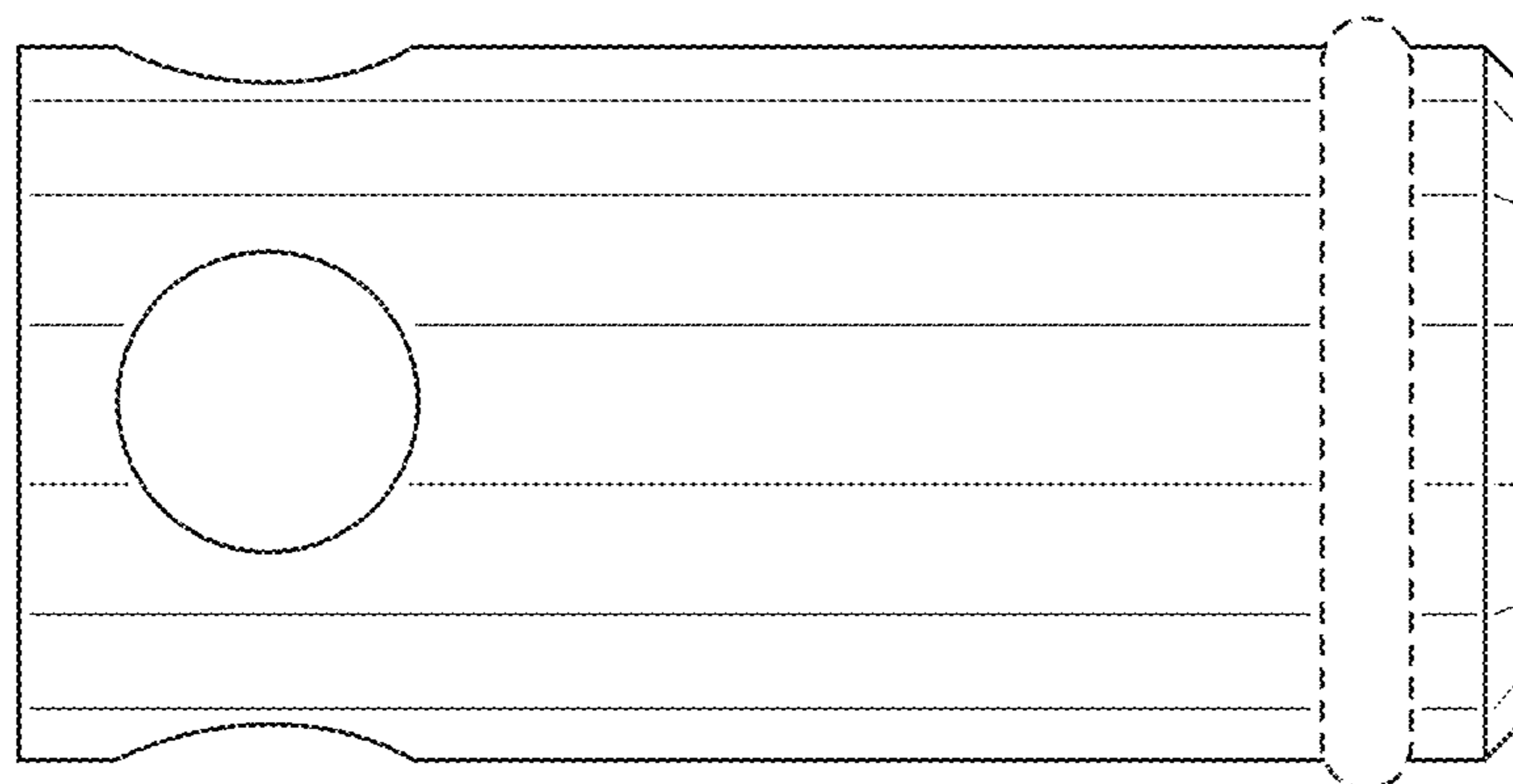

FIG. 3

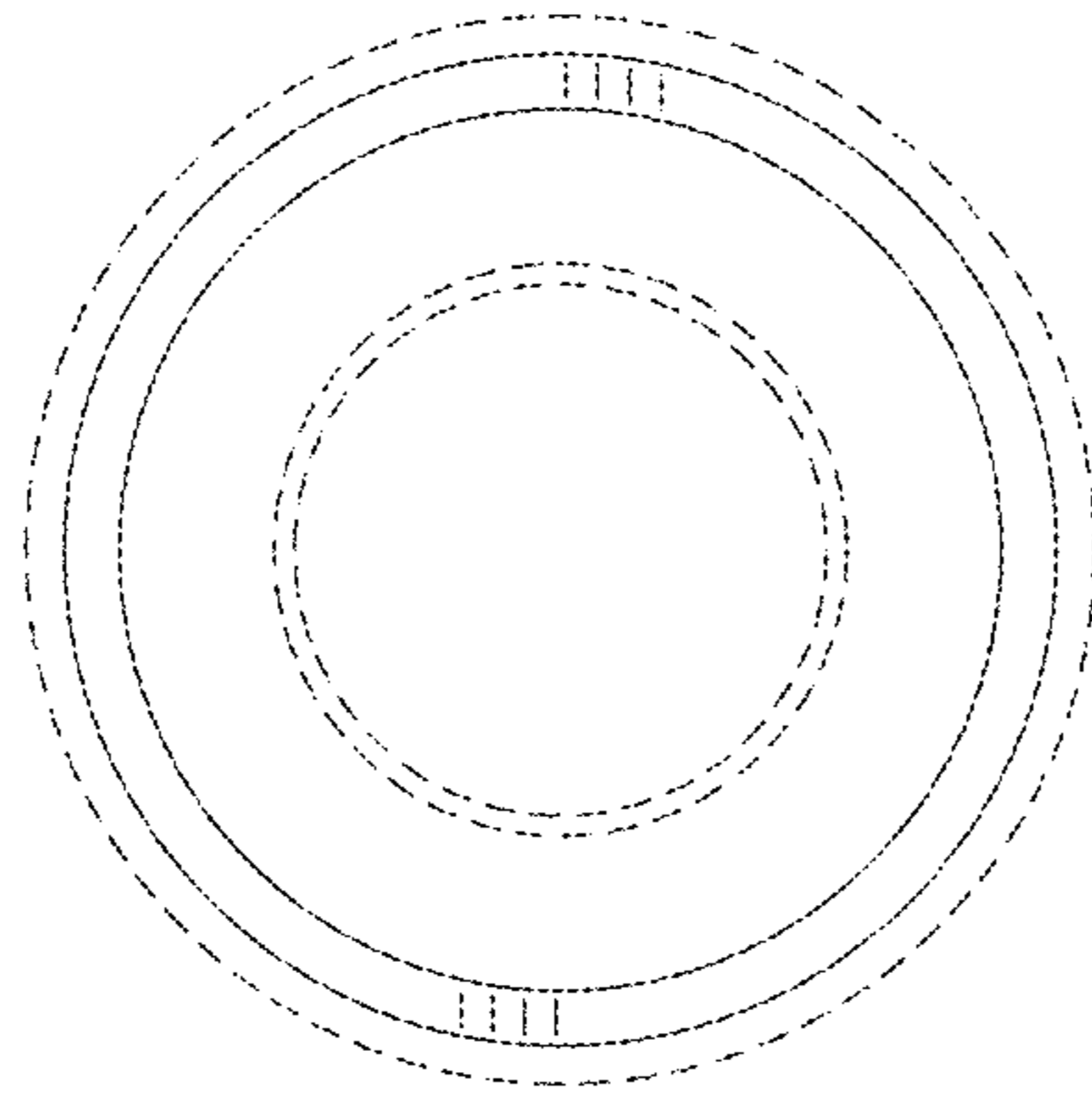

FIG. 4

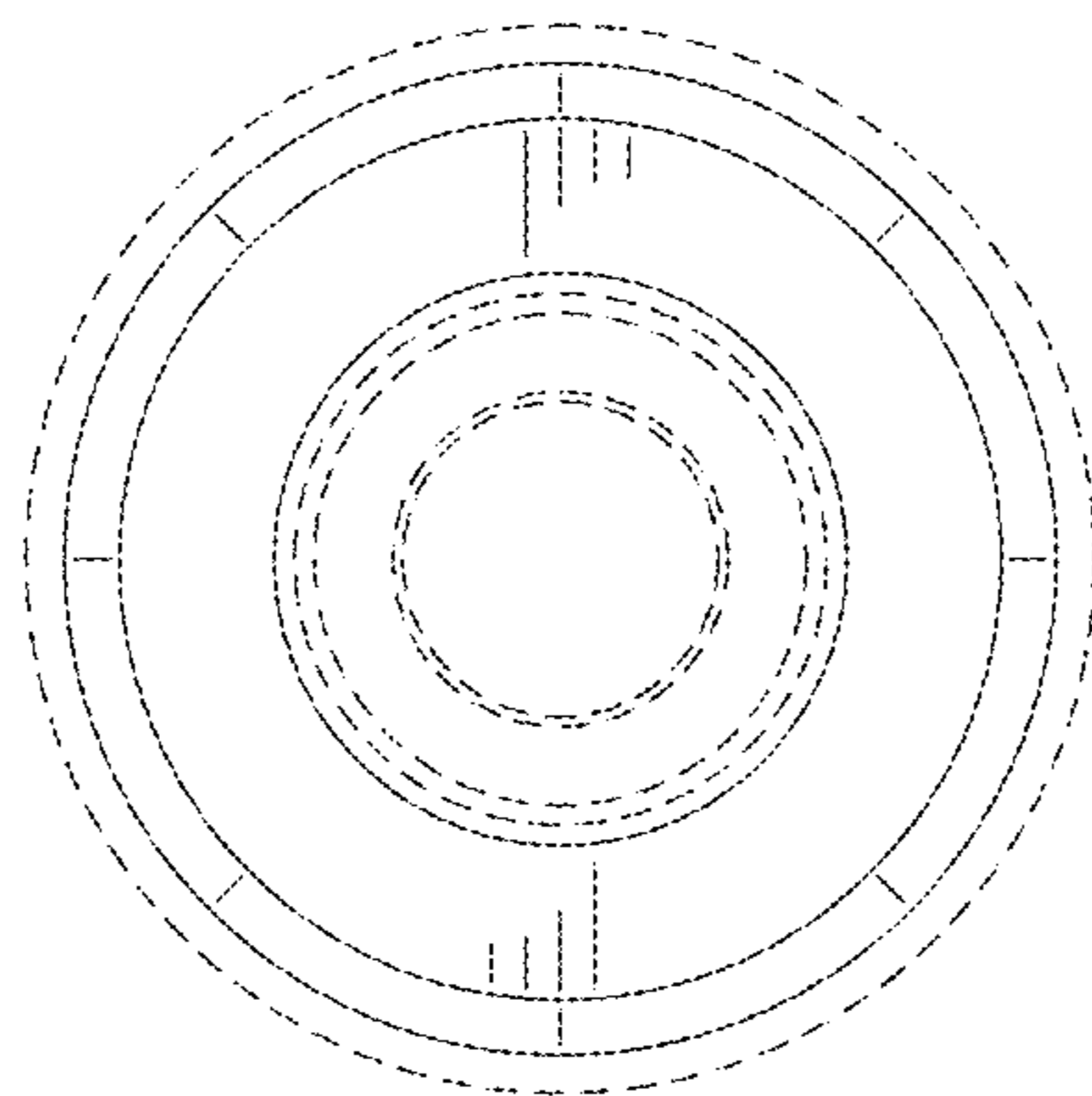

FIG. 5

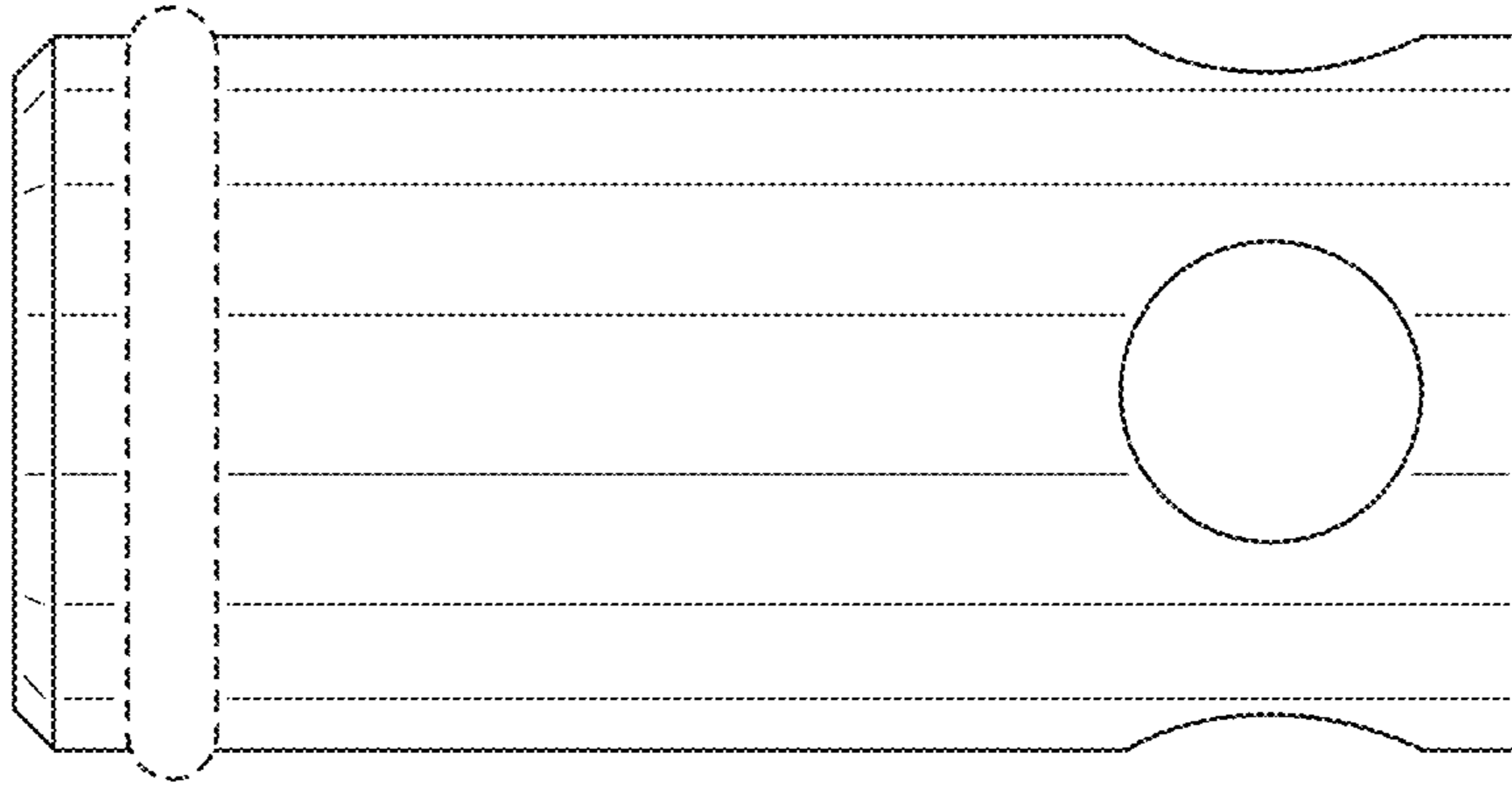

FIG. 6

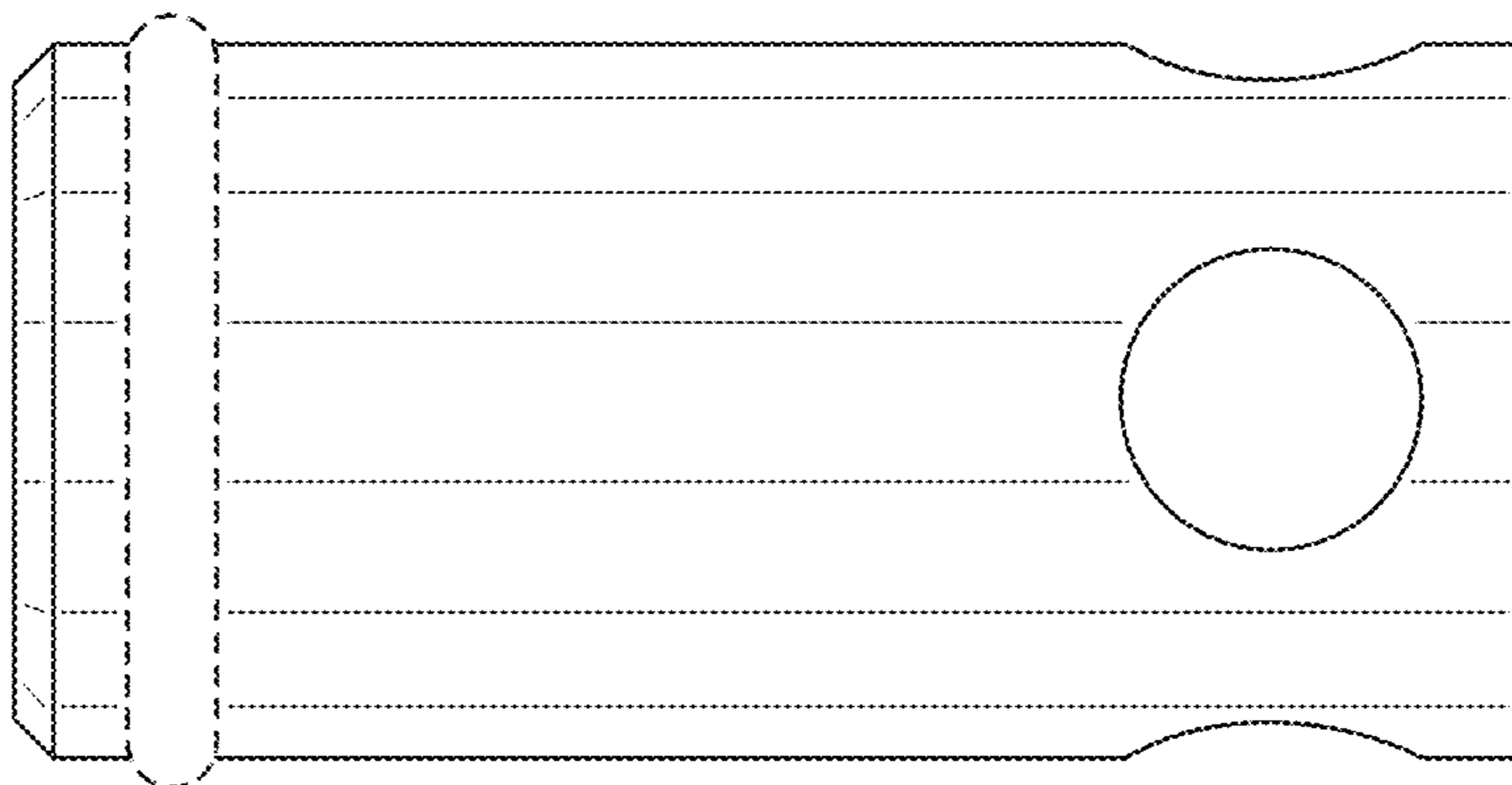

FIG. 7

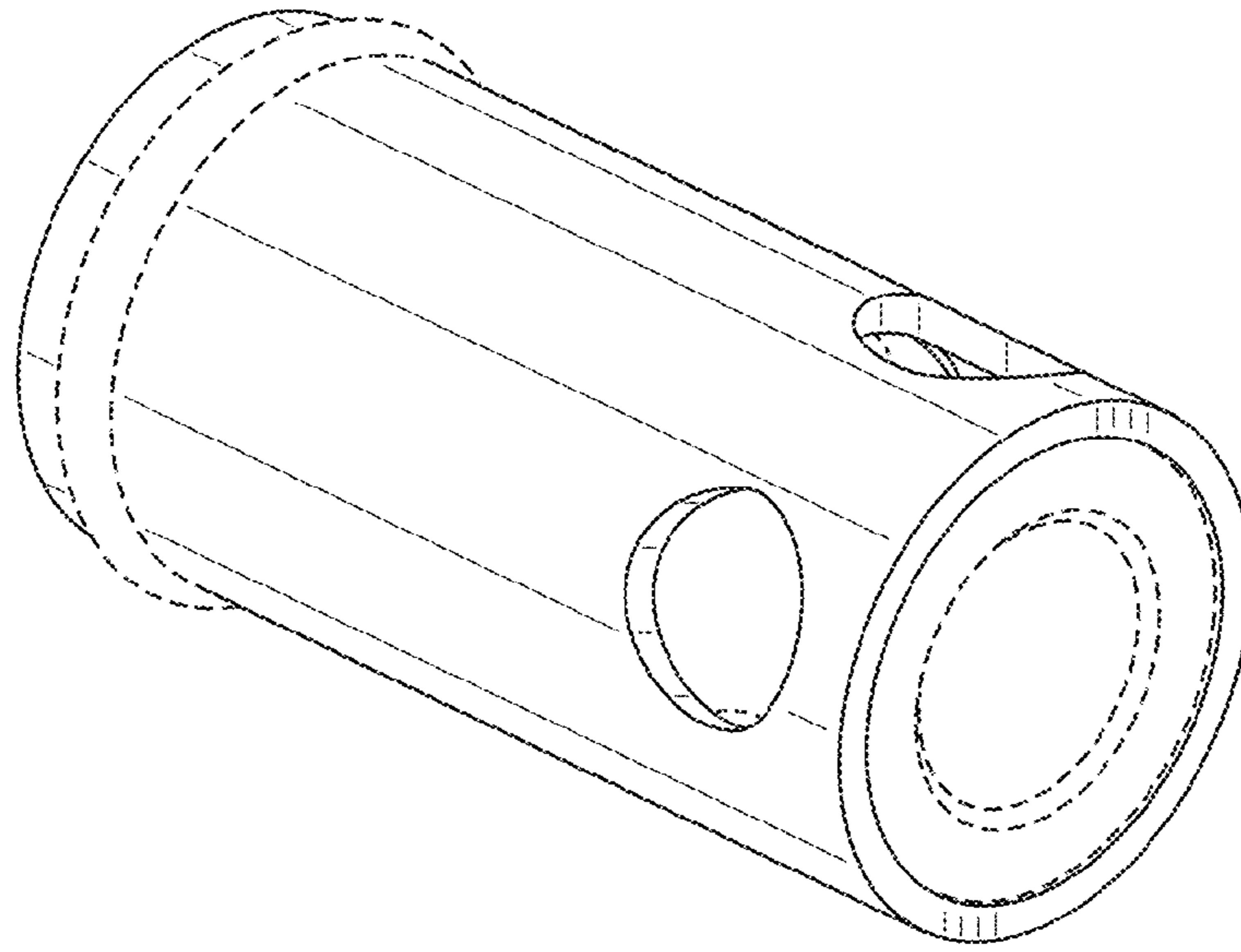

FIG. 8

