

US00D736755S

(12) **United States Design Patent**  
**Kwak et al.**

(10) **Patent No.:** **US D736,755 S**

(45) **Date of Patent:** **\*\* Aug. 18, 2015**

(54) **TELEPHONE RECEIVER**

(71) Applicant: **Samsung Electronics Co., Ltd.**,  
Suwon-si (KR)  
(72) Inventors: **Ji-Hee Kwak**, Seoul (KR); **Ji-Hyun Moon**, Gwangmyeong-si (KR); **So-Yoon Jeon**, Guri-si (KR)  
(73) Assignee: **Samsung Electronics Co., Ltd.**,  
Suwon-si (KR)

(\*\*) Term: **14 Years**  
(21) Appl. No.: **29/490,484**  
(22) Filed: **May 9, 2014**

(30) **Foreign Application Priority Data**  
Dec. 9, 2013 (KR) ..... 30-2013-0062130  
(51) **LOC (10) Cl.** ..... **14-03**  
(52) **U.S. Cl.**  
USPC ..... **D14/248**  
(58) **Field of Classification Search**  
USPC ..... D14/248, 151, 130, 140.7, 140.8, 142,  
D14/144, 149, 150, 155, 158, 159, 188, 205,  
D14/206, 217, 223, 226, 229, 240, 251–253,  
D14/399, 329, 466–468, 140; D21/517;  
D13/107, 108, 168; D10/65;  
379/88.17, 90.01, 93.17, 387.01,  
379/388.02, 419–420.04, 420.02,  
379/428.01–428.04, 434–436, 440,  
379/446–447, 454–455, 93.23; D24/165  
CPC ..... H04M 1/00; H04M 1/003; H04M 1/02;  
H04M 1/0202; H04M 1/03; H04M 1/04;  
H04M 1/20; H04M 1/21  
See application file for complete search history.

(56) **References Cited**

U.S. PATENT DOCUMENTS

4,335,280	A	*	6/1982	Butchko	.....	379/364
D299,647	S	*	1/1989	Davies	.....	D14/248
4,876,714	A	*	10/1989	Yoshida et al.	.....	379/433.03
5,042,071	A	*	8/1991	Stinauer et al.	.....	381/368
D325,915	S	*	5/1992	Nagele et al.	.....	D14/248
5,235,636	A	*	8/1993	Takagi et al.	.....	379/368
5,265,158	A	*	11/1993	Tattari	.....	379/433.08
D344,087	S	*	2/1994	Nagele et al.	.....	D14/248
D359,283	S	*	6/1995	Rudkiewicz	.....	D14/149
D372,919	S	*	8/1996	Nagele et al.	.....	D14/248
5,555,550	A	*	9/1996	Kaschke	.....	455/566
5,617,474	A	*	4/1997	Ditzig et al.	.....	379/433.01
5,822,703	A	*	10/1998	Araki	.....	455/564
D430,560	S	*	9/2000	Carazon Climent	.....	D14/248
D466,097	S	*	11/2002	Geert	.....	D14/151
D534,906	S	*	1/2007	Yamaguchi	.....	D14/248
D608,773	S	*	1/2010	Verthein et al.	.....	D14/248
D610,567	S	*	2/2010	Townsend	.....	D14/149
D666,561	S	*	9/2012	Sun et al.	.....	D13/168
D717,762	S	*	11/2014	Jeon et al.	.....	D14/151

\* cited by examiner

*Primary Examiner* — Susan Bennett Hattan

*Assistant Examiner* — Marie Fast Horse

(74) *Attorney, Agent, or Firm* — NSIP Law

(57) **CLAIM**

We claim the ornamental design for a telephone receiver, as shown and described.

**DESCRIPTION**

FIG. 1 is a front perspective view of a telephone receiver showing our new design;  
FIG. 2 is a front view thereof;  
FIG. 3 is a rear view thereof;  
FIG. 4 is a left-side view thereof;  
FIG. 5 is a right-side view thereof;  
FIG. 6 is a top view thereof;  
FIG. 7 is a bottom view thereof; and,  
FIG. 8 is a rear perspective view thereof.  
The broken lines in the figures show portions of the telephone receiver which form no part of the claimed design.

**1 Claim, 5 Drawing Sheets**

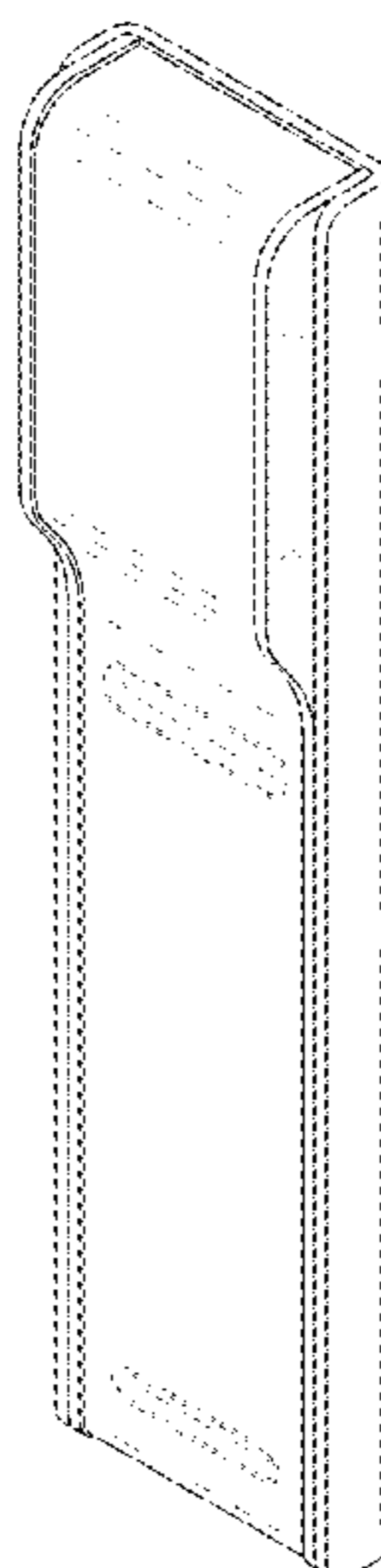

FIG. 1

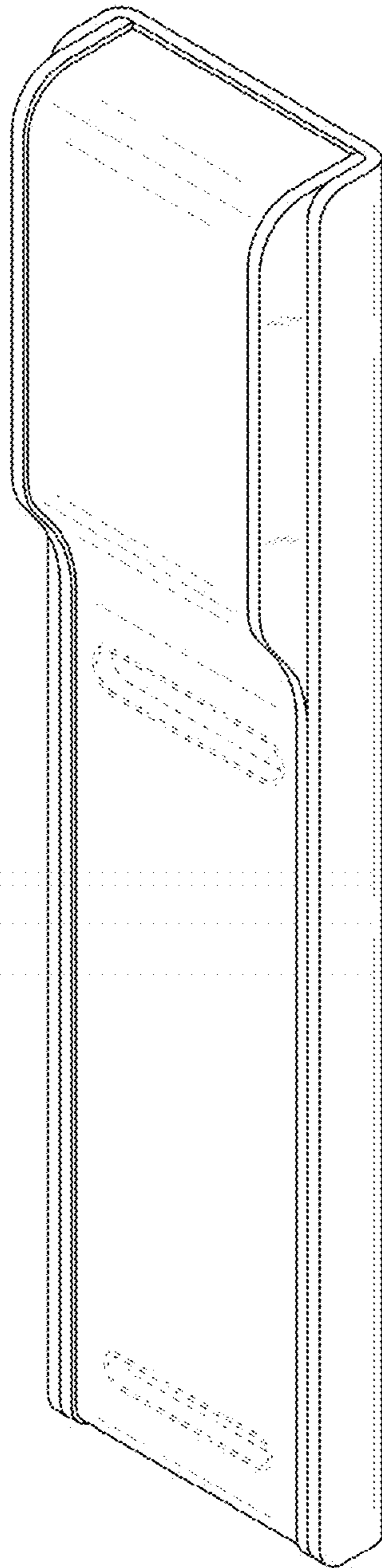

FIG.2

FIG.3

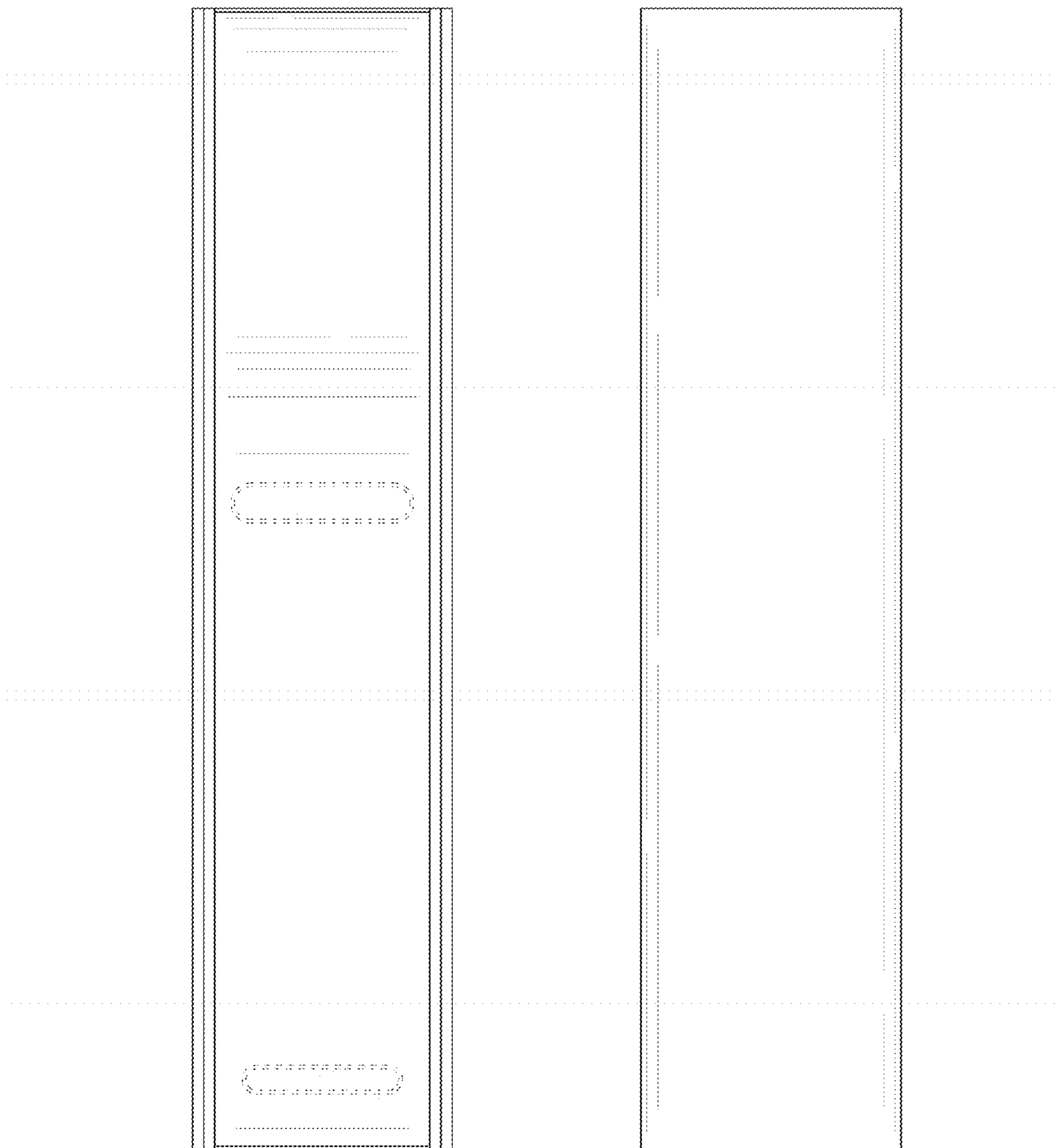

FIG.4

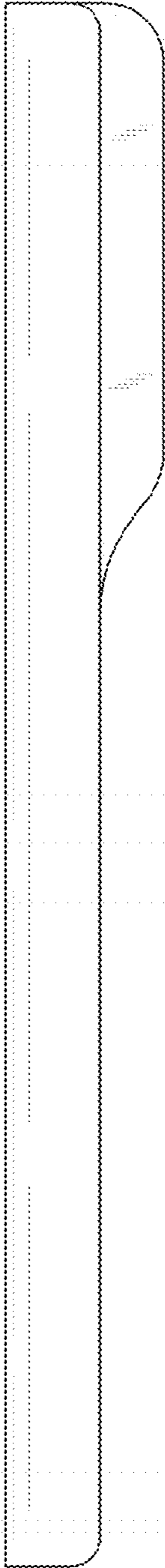

FIG.5

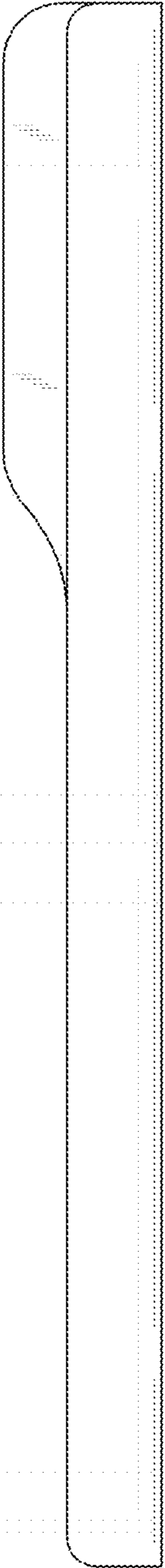

FIG.6

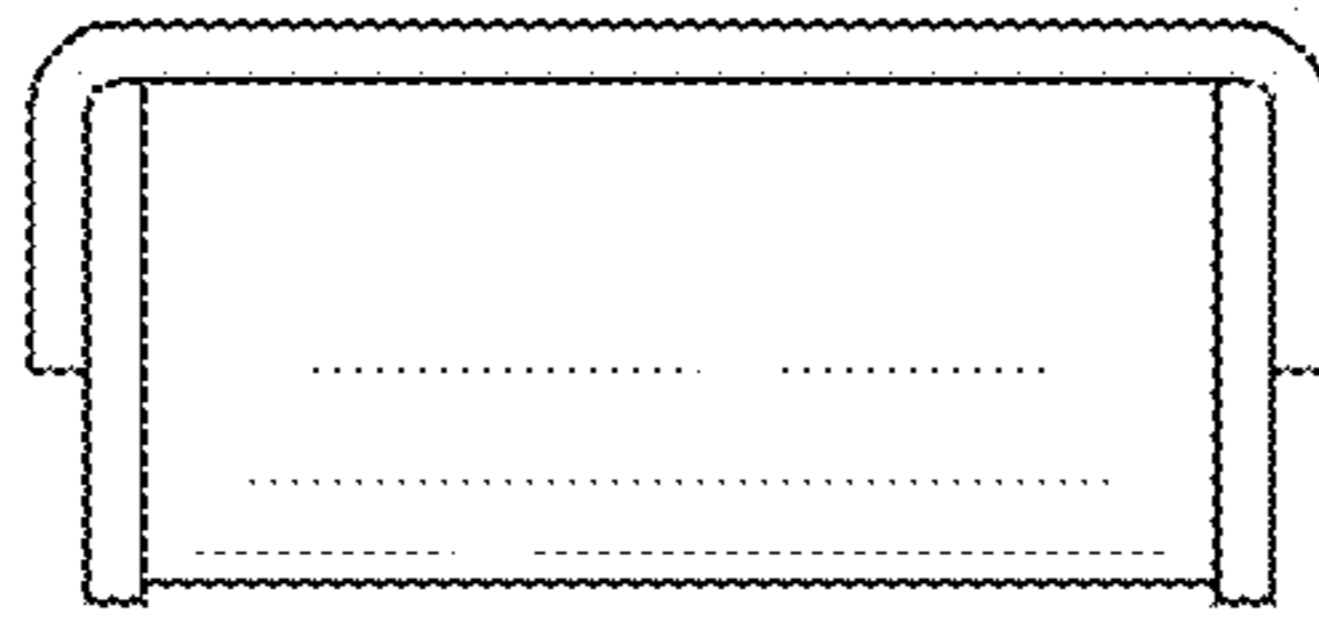

FIG.7

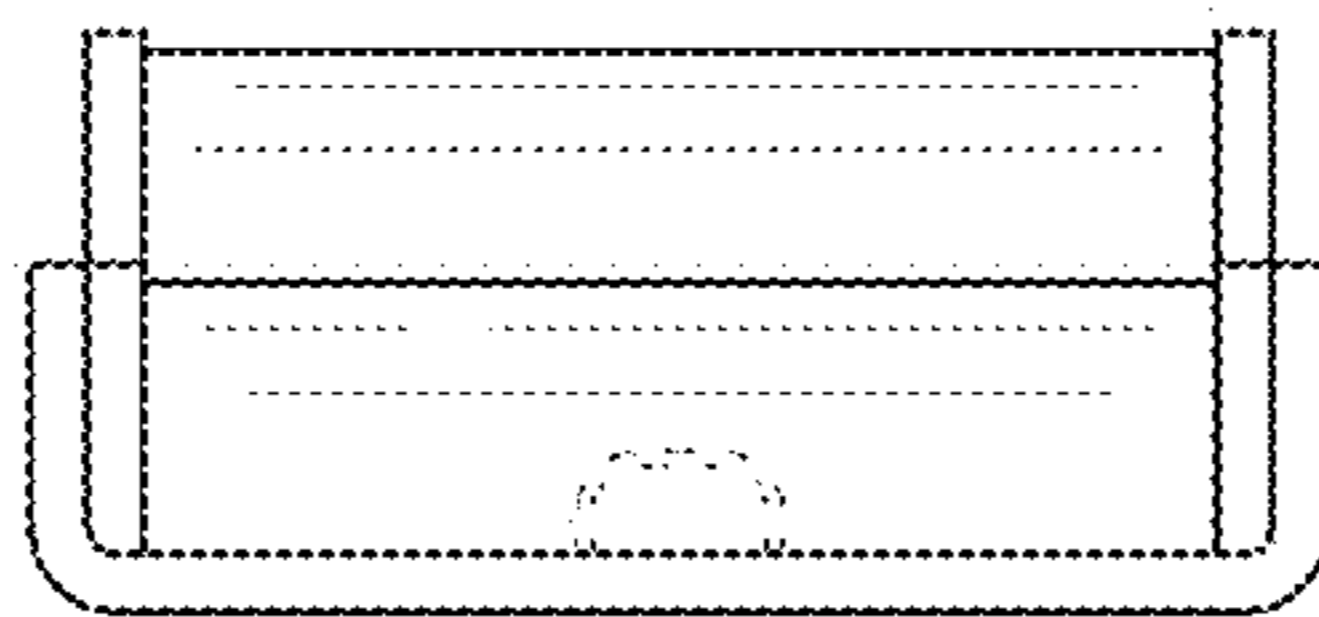

FIG.8

