



US00D736735S

(12) **United States Design Patent**
Ishii

(10) **Patent No.:** **US D736,735 S**

(45) **Date of Patent:** **** Aug. 18, 2015**

(54) **PORTABLE TERMINAL**

(71) Applicant: **KYOCERA CORPORATION**,
Kyoto-shi, Kyoto (JP)

(72) Inventor: **Atsushi Ishii**, Osaka (JP)

(73) Assignee: **KYOCERA Corporation**, Kyoto (JP)

(**) Term: **14 Years**

(21) Appl. No.: **29/472,562**

(22) Filed: **Nov. 13, 2013**

(30) **Foreign Application Priority Data**

Sep. 6, 2013 (JP) 2013-020622

(51) **LOC (10) Cl.** **14-03**

(52) **U.S. Cl.**
USPC **D14/138 G**

(58) **Field of Classification Search**
USPC D14/138 G, 138 AD, 341-347, 138 AA,
D14/138 AB, 138 R, 138 AC, 138 C, 138,
D14/137, 147, 218, 247, 248, 191,
D14/203.1-203.8, 496; D13/168; D21/324,
D21/329, 517; 455/566, 575.1, 575.3,
455/575.4; D10/65, 78, 104.1, 104.2
CPC H04M 1/0202; H04M 1/0235; H04M
1/0237; H04M 1/0239; H04M 2250/52;
H04M 1/0266; H04M 1/0268; H04M 1/0295;
H04M 2250/22; G06F 1/1626; G06F 1/1624
See application file for complete search history.

(56) **References Cited**

U.S. PATENT DOCUMENTS

D573,143 S * 7/2008 Park et al. D14/341
D577,704 S * 9/2008 Park et al. D14/138 G
D593,059 S * 5/2009 Kim et al. D14/138 G
D597,512 S * 8/2009 Kim et al. D14/138 G
D606,129 S * 12/2009 Ben-Moshe D21/517
D612,355 S * 3/2010 Luo D14/138 AC

D621,811 S * 8/2010 Chen D14/138 G
D624,896 S * 10/2010 Park et al. D14/138 G
D638,003 S * 5/2011 Chen D14/242
D640,219 S * 6/2011 Sutherland et al. D14/138 G
D653,641 S * 2/2012 Chen D14/138 G
D656,918 S * 4/2012 Kim et al. D14/138 G
D663,711 S * 7/2012 Lee et al. D14/138 G

(Continued)

FOREIGN PATENT DOCUMENTS

CN 302175476 * 11/2012
CN 302202406 * 11/2012

(Continued)

OTHER PUBLICATIONS

Samsung Galaxy S II Skyrocket HD, announced Jan. 2012, [online],
[retrieved on Feb. 3, 2012]. Retrieved from Internet ,<URL: http://
www.gsmarena.com>.*

(Continued)

Primary Examiner — Bridget L Eland
Assistant Examiner — Lauren McVey
(74) *Attorney, Agent, or Firm* — Studebaker & Brackett PC

(57) **CLAIM**
The ornamental design for portable terminal, as shown and
described.

DESCRIPTION

FIG. 1 is a front perspective view of a portable terminal
showing my new design;
FIG. 2 is a rear perspective view thereof;
FIG. 3 is a front view thereof;
FIG. 4 is a rear view thereof;
FIG. 5 is a left side view thereof;
FIG. 6 is a right side view thereof.
FIG. 7 is a top plan view thereof; and,
FIG. 8 is a bottom view thereof.

1 Claim, 6 Drawing Sheets

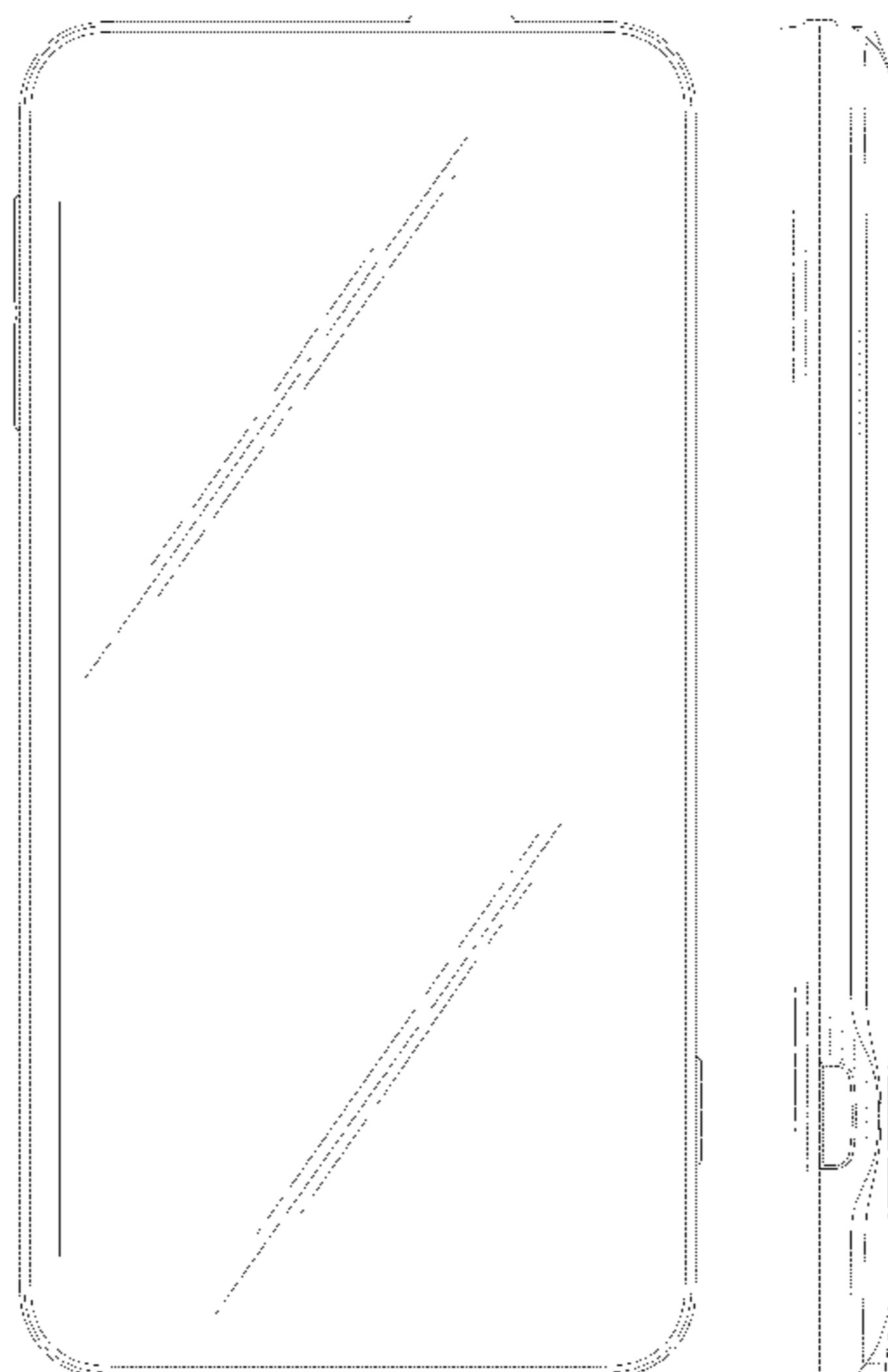

(56)

References Cited

U.S. PATENT DOCUMENTS

D670,260	S	*	11/2012	Kim et al.	D14/138	G
D671,089	S	*	11/2012	Joung et al.	D14/138	G
D672,344	S	*	12/2012	Li	D14/341	
D675,586	S	*	2/2013	Choi	D14/138	G
D676,819	S	*	2/2013	Choi	D14/138	G
D681,594	S	*	5/2013	Hong	D14/138	G
D695,247	S	*	12/2013	Kim et al.	D14/138	G
D700,161	S	*	2/2014	Yoshihara	D14/138	G
D720,713	S	*	1/2015	Huang et al.	D14/138	G
2008/0259094	A1	*	10/2008	Kim et al.	345/651	
2009/0170573	A1	*	7/2009	Harmon et al.	455/575.4	
2011/0151945	A1	*	6/2011	Jiang et al.	455/575.1	

FOREIGN PATENT DOCUMENTS

CN	302279532	*	1/2013
CN	302290082	*	1/2013
CN	302497139	*	7/2013
CN	302694786	*	12/2013

OTHER PUBLICATIONS

LG Optimus Black, announced Jan. 2011, [online], [retrieved on Jan. 6, 2011]. Retrieved from Internet ,<URL: <http://www.gsmarena.com>>.*

Sharp 825SH, announced Jun. 2008, [online], [retrieved on Apr. 16, 2009]. Retrieved from Internet ,<URL: <http://www.gsmarena.com>>.*

LG KM900 Arena, announced Feb. 2009, [online], [retrieved on Feb. 20, 2009]. Retrieved from Internet ,<URL: <http://www.gsmarena.com>>.*

LG Optimus 2X, announced Dec. 2010, [online], [retrieved on Jan. 6, 2011]. Retrieved from Internet ,<URL: <http://www.gsmarena.com>>.*

Kyocera: Hydro Elite <http://www.kyocera-wireless.com/hydro-elite-phone/>.

LG: Optimus F3 (LS720 Titanium Silver) <http://www.lg.com/us/cell-phones/1G-LS720-Titanium-Silver-optimus-f3>.

ZTE: ZTE Blade G http://www.gsmarena.com/zte_blade_g_v880g-5620.php.

* cited by examiner

FIG. 1

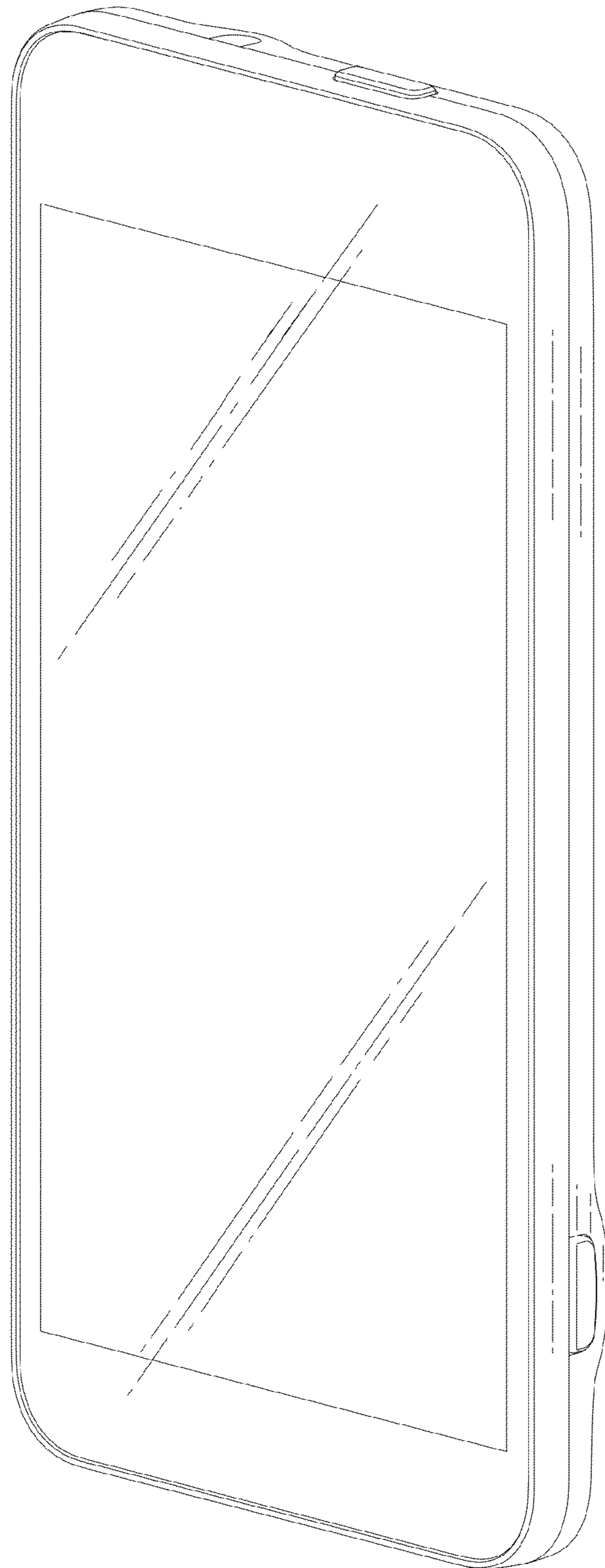

FIG. 2

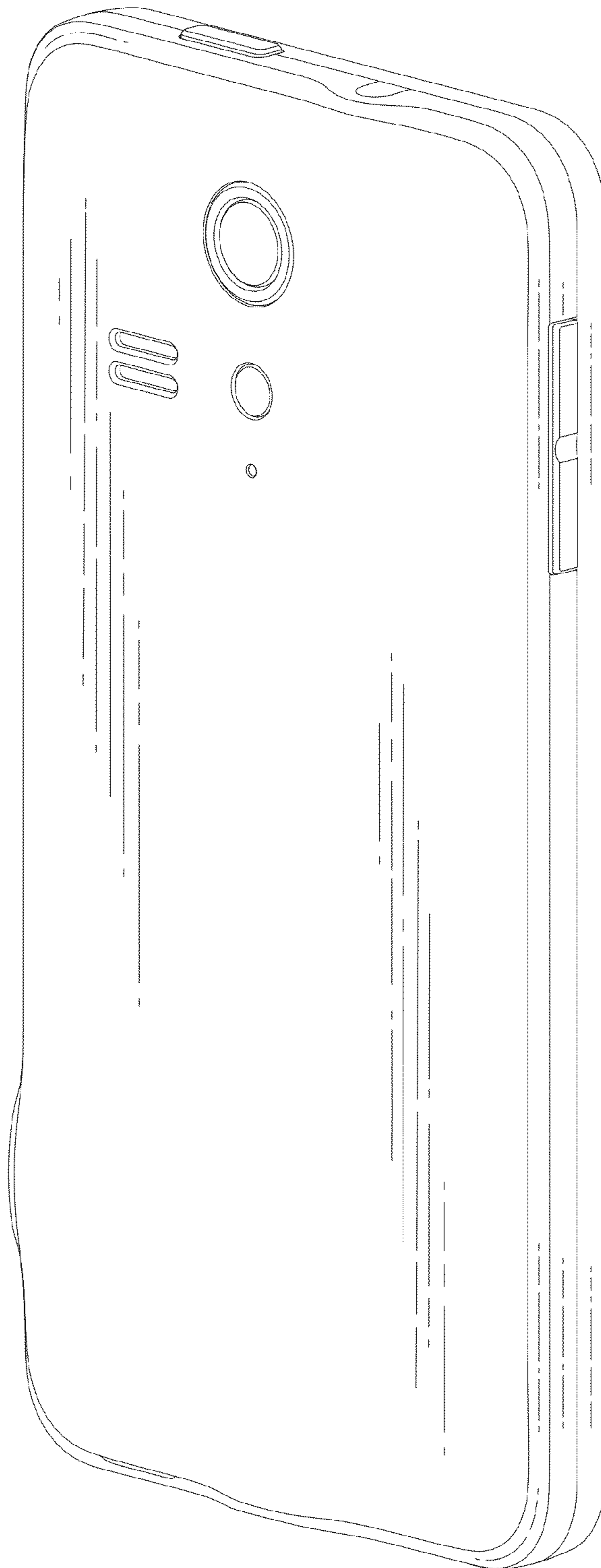

FIG. 3

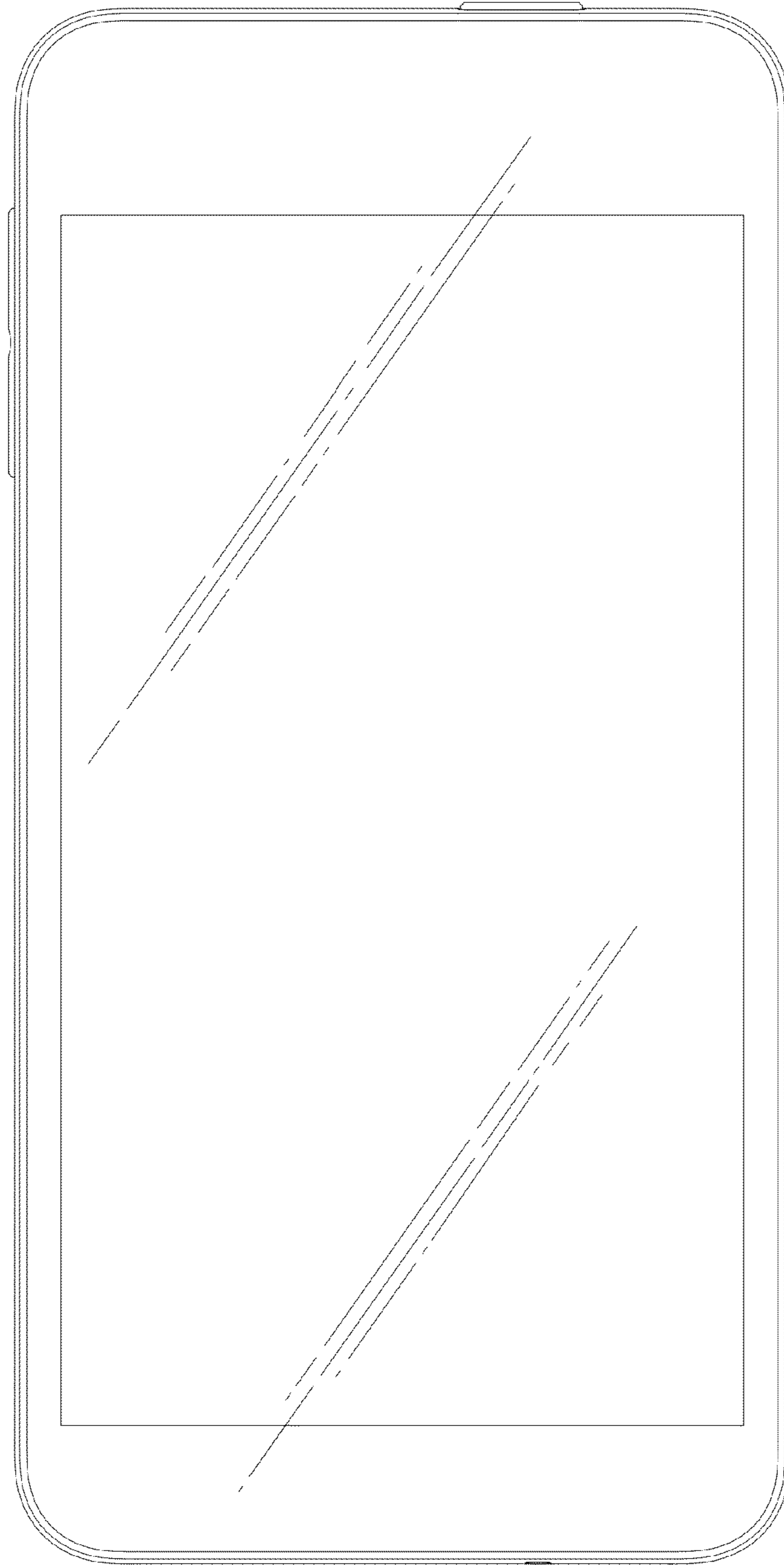

FIG. 4

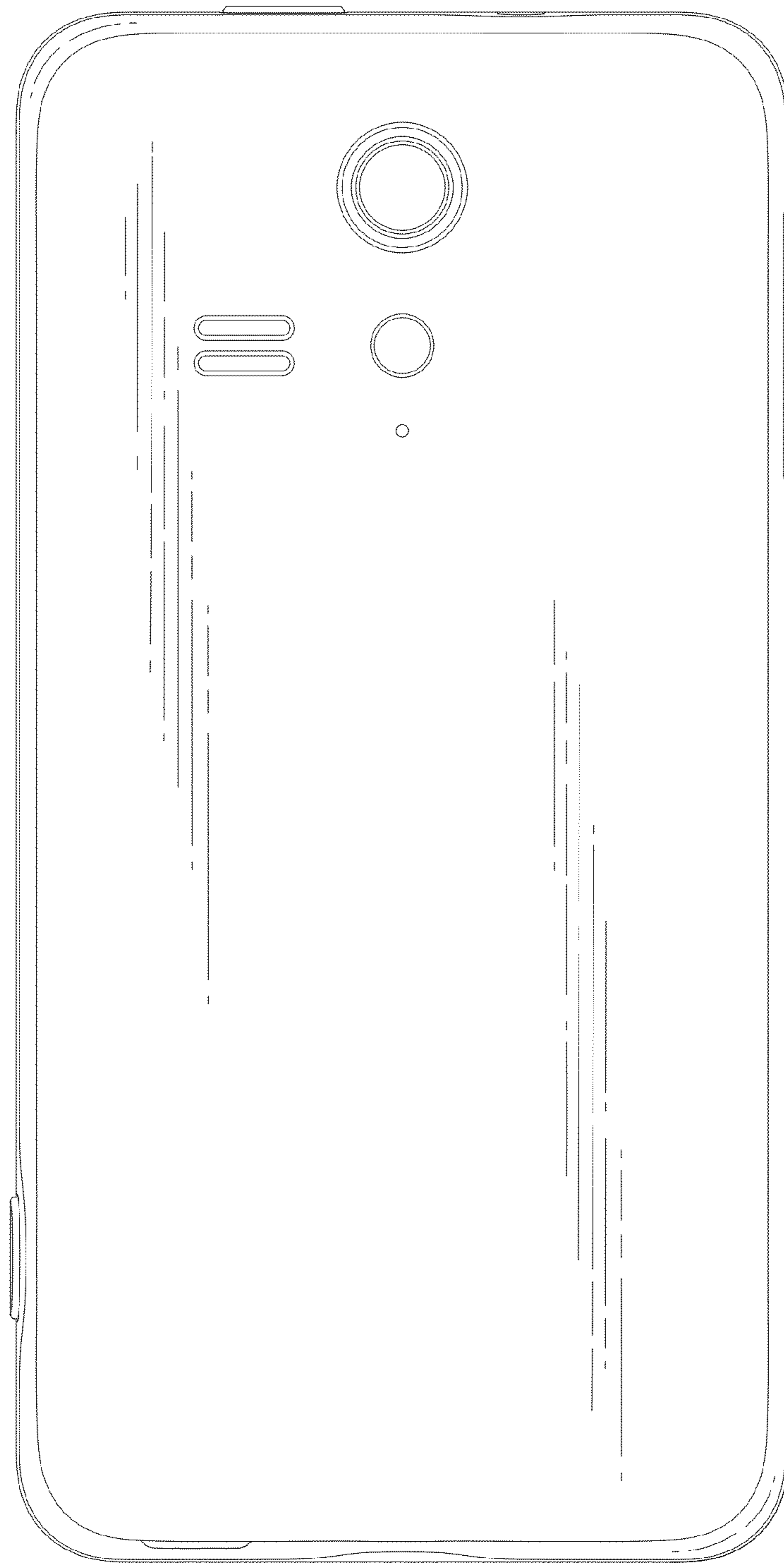

FIG. 5

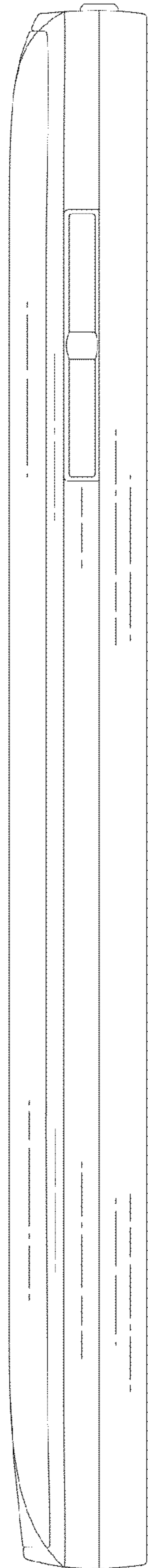

FIG. 6

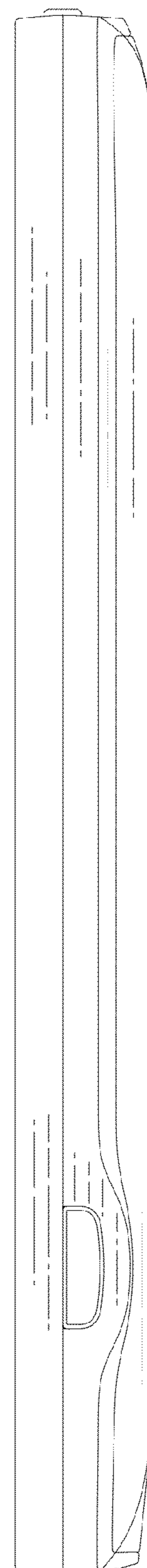

FIG. 7

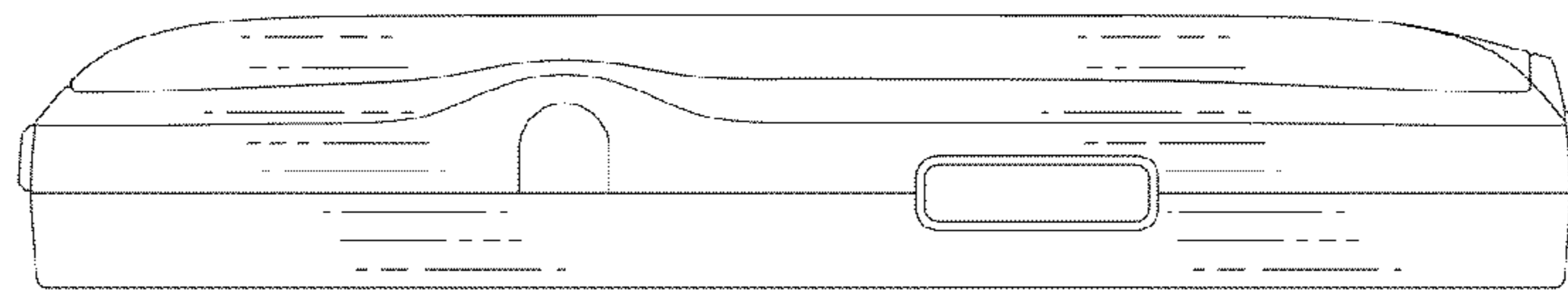

FIG. 8

