



US00D736683S

(12) **United States Design Patent**  
**Glover et al.**

(10) **Patent No.:** **US D736,683 S**

(45) **Date of Patent:** **\*\* Aug. 18, 2015**

(54) **VEHICLE LOWER FRONT END**

(56) **References Cited**

(71) Applicants: **Jeremy Glover**, Clawson, MI (US);  
**Brian Nielander**, Royal Oak, MI (US);  
**Mark T Allen**, Oxford, MI (US)

U.S. PATENT DOCUMENTS

D635,067 S *	3/2011	Kozai et al. ....	D12/169
D640,957 S *	7/2011	Bauer et al. ....	D12/169
D670,625 S *	11/2012	Frei et al. ....	D12/169
D705,706 S *	5/2014	Kawasaki ....	D12/169
D713,308 S	9/2014	Galante	
D718,681 S *	12/2014	Allen et al. ....	D12/169

(72) Inventors: **Jeremy Glover**, Clawson, MI (US);  
**Brian Nielander**, Royal Oak, MI (US);  
**Mark T Allen**, Oxford, MI (US)

\* cited by examiner

(73) Assignee: **FCA US LLC**, Auburn Hills, MI (US)

*Primary Examiner* — Melody N Brown

(\*\*) Term: **14 Years**

(74) *Attorney, Agent, or Firm* — Ralph E Smith

(21) Appl. No.: **29/507,346**

(57) **CLAIM**

The ornamental design for a vehicle lower front end, as shown and described.

(22) Filed: **Oct. 27, 2014**

**DESCRIPTION**

**Related U.S. Application Data**

(63) Continuation-in-part of application No. 29/482,347, filed on Feb. 18, 2014, now Pat. No. Des. 728,425.

FIG. 1 is a front perspective view of a vehicle lower front end showing our new design;

(51) **LOC (10) Cl.** ..... **12-16**

FIG. 2 is a front elevational view thereof;

(52) **U.S. Cl.**

USPC ..... **D12/169**

FIG. 3 is a rear/inner view thereof;

(58) **Field of Classification Search**

USPC ..... D12/169, 216, 90-92, 86, 171, 196,  
D12/163; 293/102, 113, 115, 117, 120;  
296/180.1, 180.2

FIG. 4 is a left side view thereof;

FIG. 5 is a right side view thereof;

FIG. 6 is a top view thereof; and,

FIG. 7 is a bottom view.

CPC ..... B60R 19/02; B60R 19/04; B62D 25/08

See application file for complete search history.

It will be understood that the broken lines shown in the drawings illustrate portions of the vehicle lower front end that form no part of claimed design.

**1 Claim, 6 Drawing Sheets**

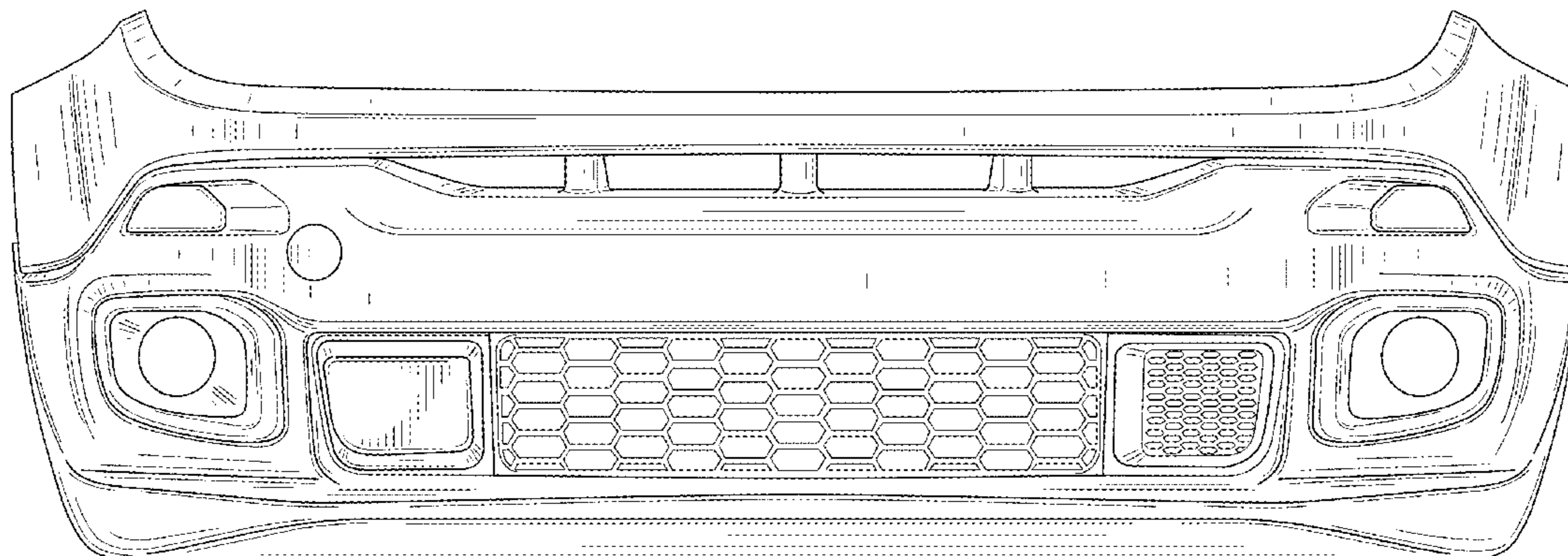

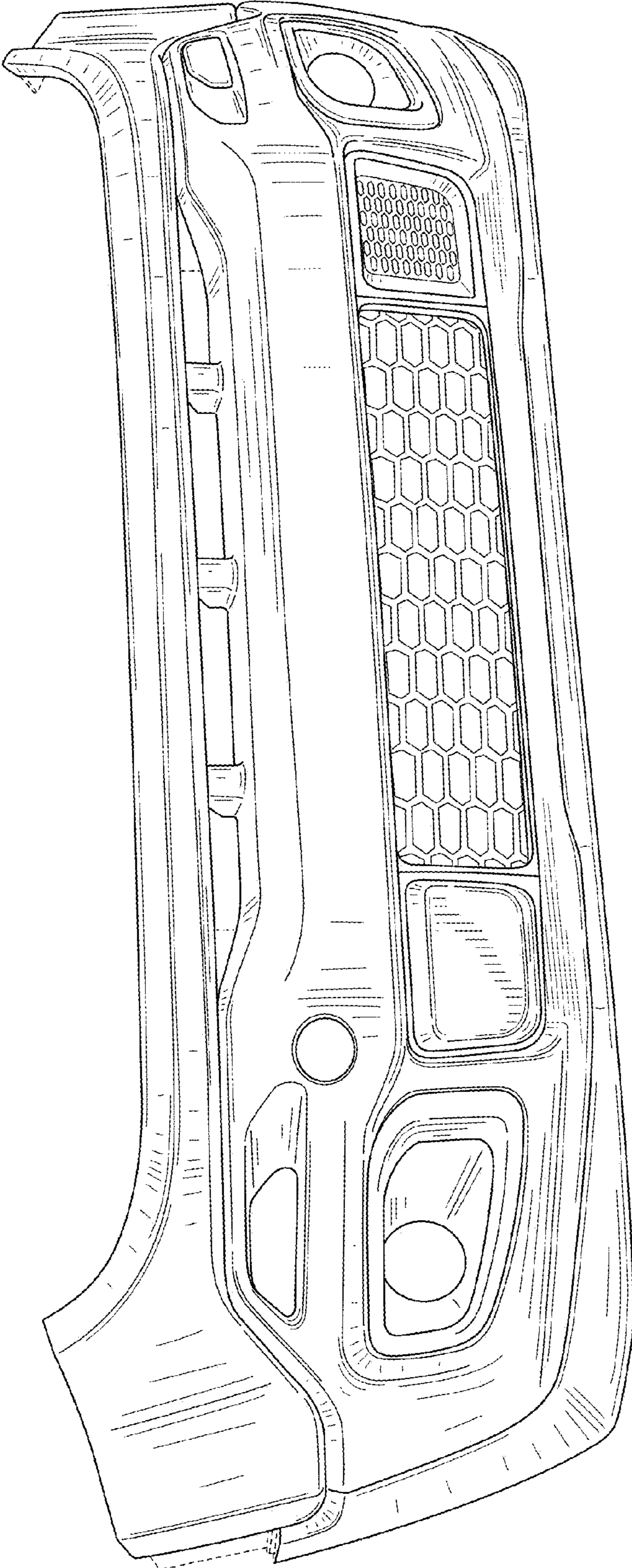

FIG. 1

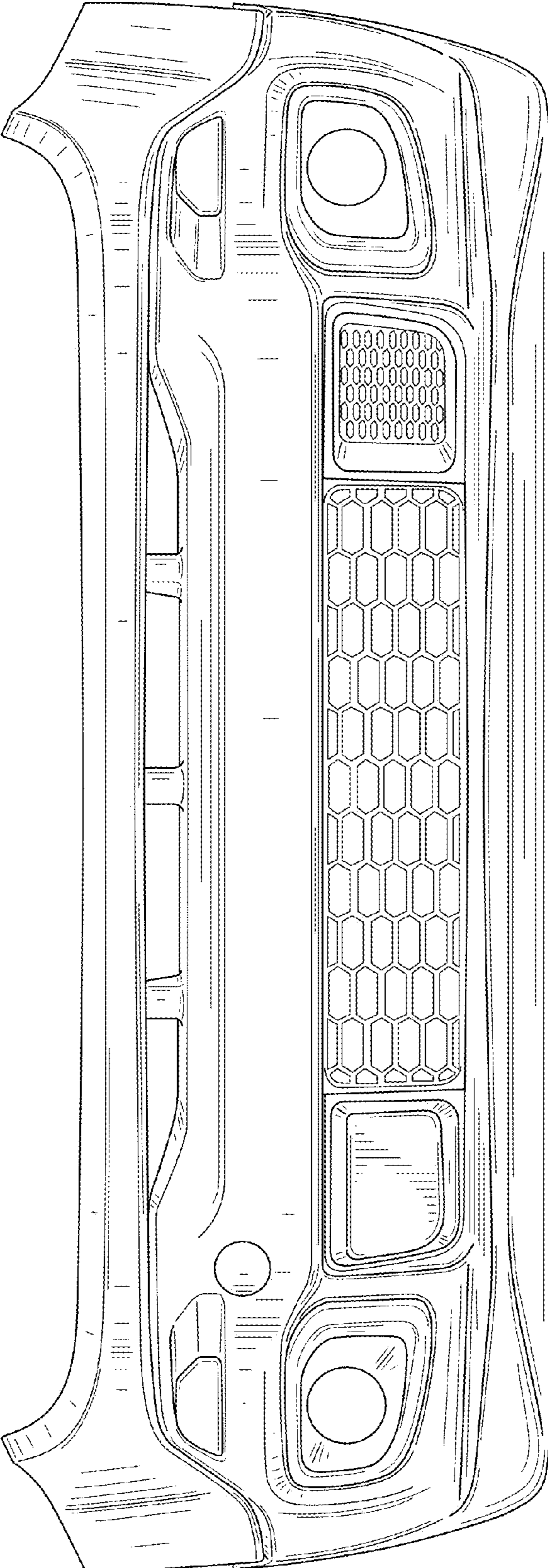

FIG. 2

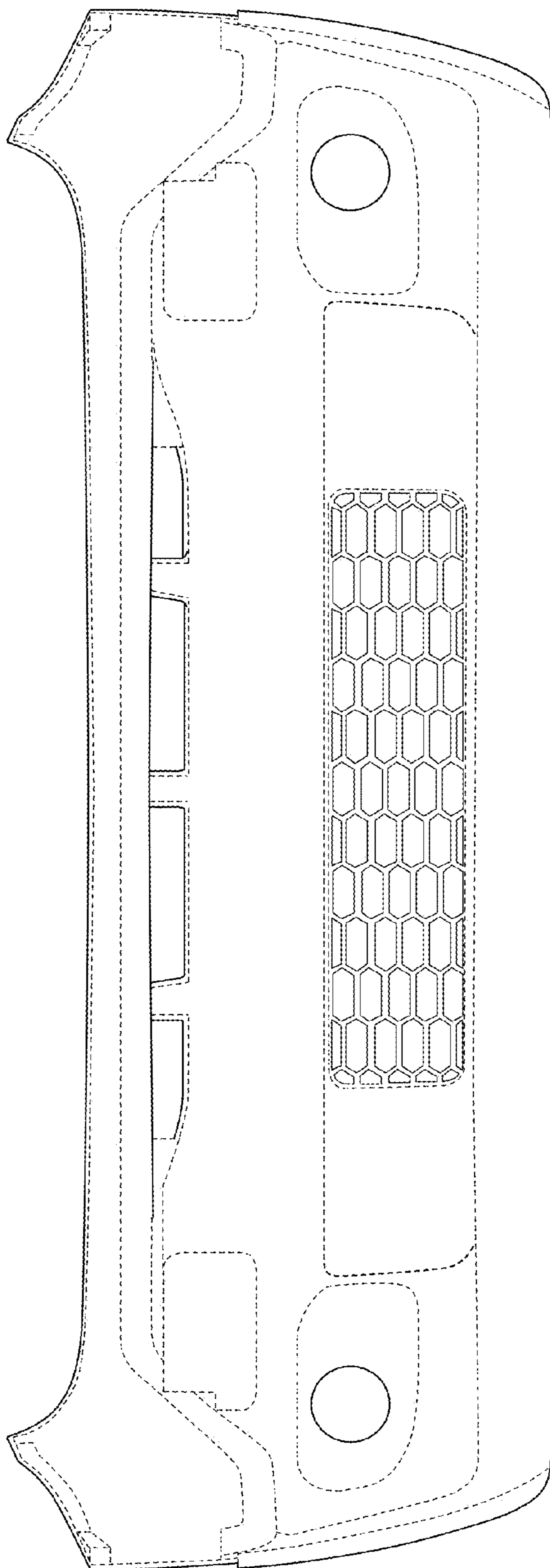

FIG. 3

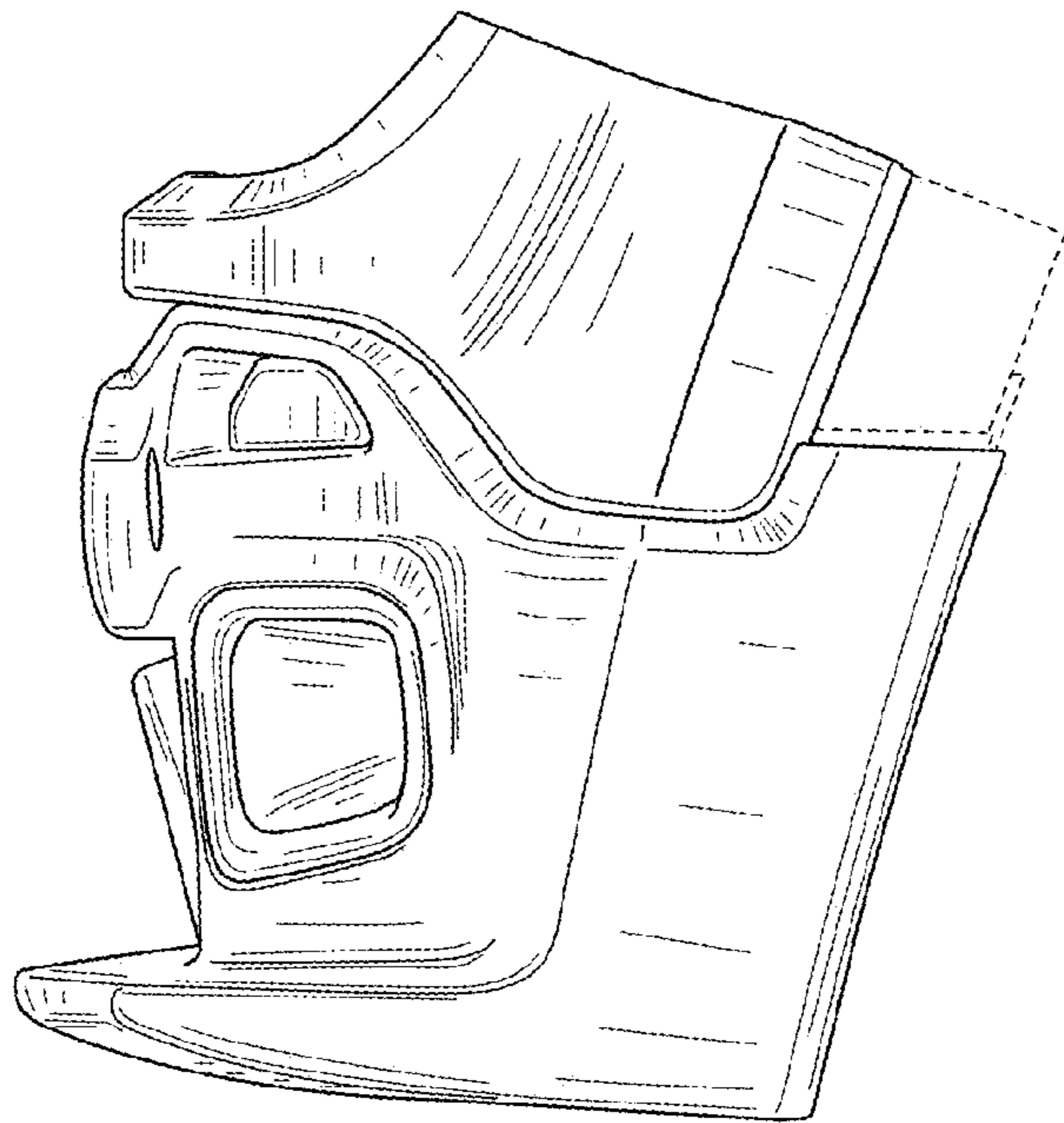

FIG. 4

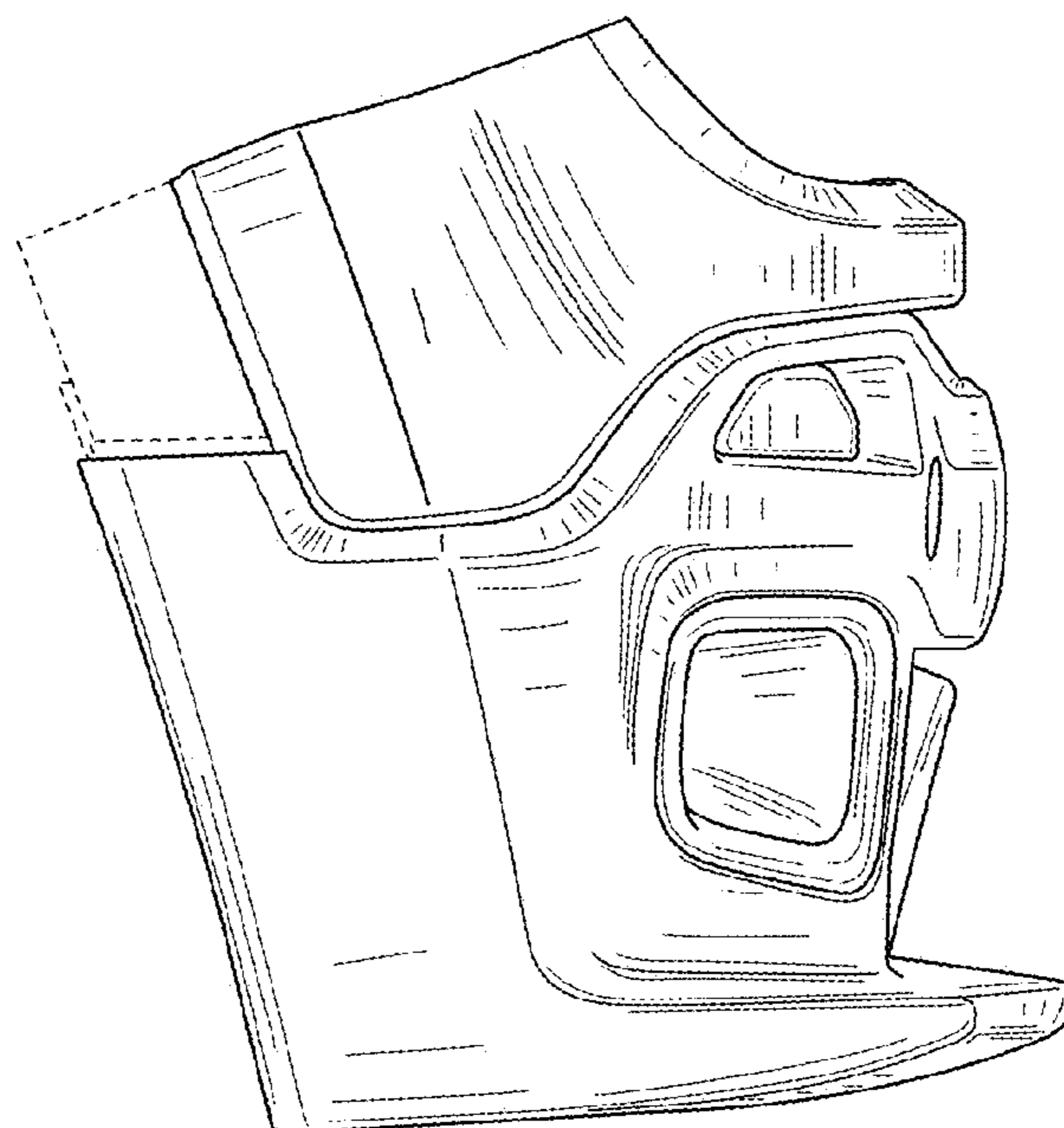

FIG. 5

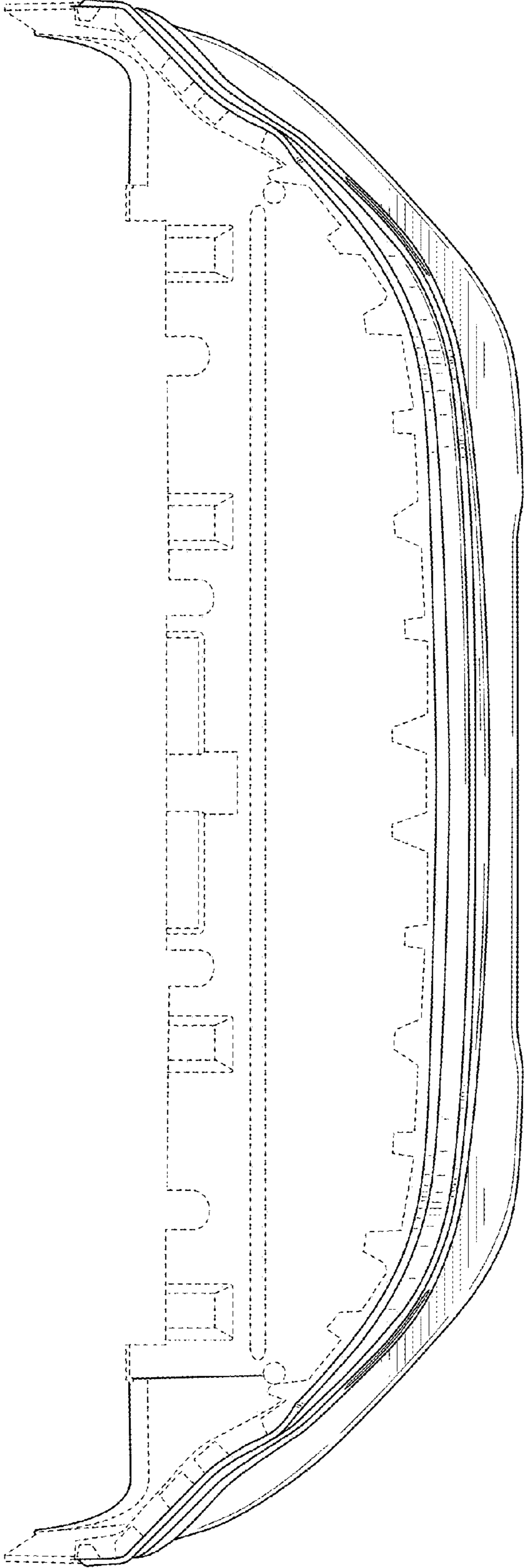

FIG. 6

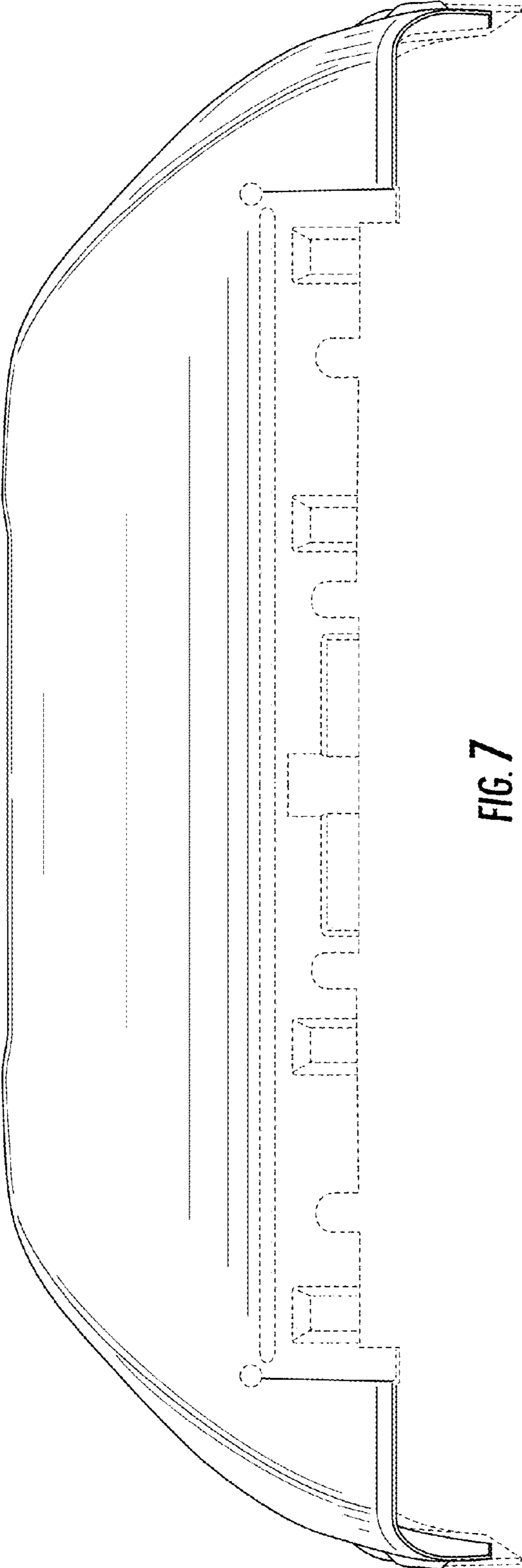

FIG. 7