

US00D736629S

(12) **United States Design Patent**
Fleischhacker

(10) **Patent No.:** **US D736,629 S**

(45) **Date of Patent:** **** Aug. 18, 2015**

(54) **PLASTIC CONTAINER**

(71) Applicant: **PLASTIPAK PACKAGING, INC.**,
Plymouth, MI (US)

(72) Inventor: **Kyle Fleischhacker**, Detroit, MI (US)

(73) Assignee: **Plastipak Packaging, Inc.**, Plymouth,
MI (US)

(**) Term: **14 Years**

(21) Appl. No.: **29/497,443**

(22) Filed: **Jul. 24, 2014**

(51) **LOC (10) Cl.** **09-01**

(52) **U.S. Cl.**

USPC **D9/500**

(58) **Field of Classification Search**

USPC D9/500, 502-505, 516, 520, 530,
D9/537-545, 548-550, 558, 715, 719;
215/11.1, 379, 381-384; 220/660, 669,
220/675

CPC B65D 1/00; B65D 1/02; B65D 1/0223;
B65D 23/00; B65D 23/001; B65D 83/00;
B65D 91/00; B65D 91/02; B65D 2501/00;
B65D 2501/0009

See application file for complete search history.

(56) **References Cited**

U.S. PATENT DOCUMENTS

D412,281 S * 7/1999 Lindsay et al. D9/500
D415,030 S * 10/1999 Searle D9/520
D567,106 S * 4/2008 Simpson et al. D9/667
D571,213 S * 6/2008 Le Bras-Brown et al. D9/516
D574,252 S * 8/2008 Ryan et al. D9/600
D575,154 S * 8/2008 Andrews et al. D9/500
D580,770 S * 11/2008 Matauch D9/551

D640,559 S * 6/2011 Llerena D9/500
D655,619 S * 3/2012 Soliman D9/690
D660,703 S * 5/2012 Barsoumian et al. D9/500
D664,809 S * 8/2012 Eyal D7/510
D694,626 S * 12/2013 Barsoumian et al. D9/500
D697,423 S * 1/2014 Infahsaeng D9/652
2011/0017701 A1 * 1/2011 Soliman 215/381

FOREIGN PATENT DOCUMENTS

WO DM/068307 * 8/2006

* cited by examiner

Primary Examiner — Ian Simmons

Assistant Examiner — Dana L Meyrow

(74) *Attorney, Agent, or Firm* — Dykema Gossett PLLC

(57) **CLAIM**

The ornamental design for a plastic container, as shown and described.

DESCRIPTION

FIG. 1 is a top, front, left side perspective view of a plastic container showing my new design;

FIG. 2 is a front elevational view of FIG. 1;

FIG. 3 is a rear elevational view of FIG. 1;

FIG. 4 is a right side elevational view of FIG. 1;

FIG. 5 is a left side elevational view of FIG. 1;

FIG. 6 is a top plan view of FIG. 1; and,

FIG. 7 is a bottom plan view of FIG. 1.

The evenly-dashed broken lines in the drawings illustrate the portions of the design that form no part of the claim. The dot-dot-dash broken lines in the drawings define the bounds of the claim and form no part thereof.

1 Claim, 4 Drawing Sheets

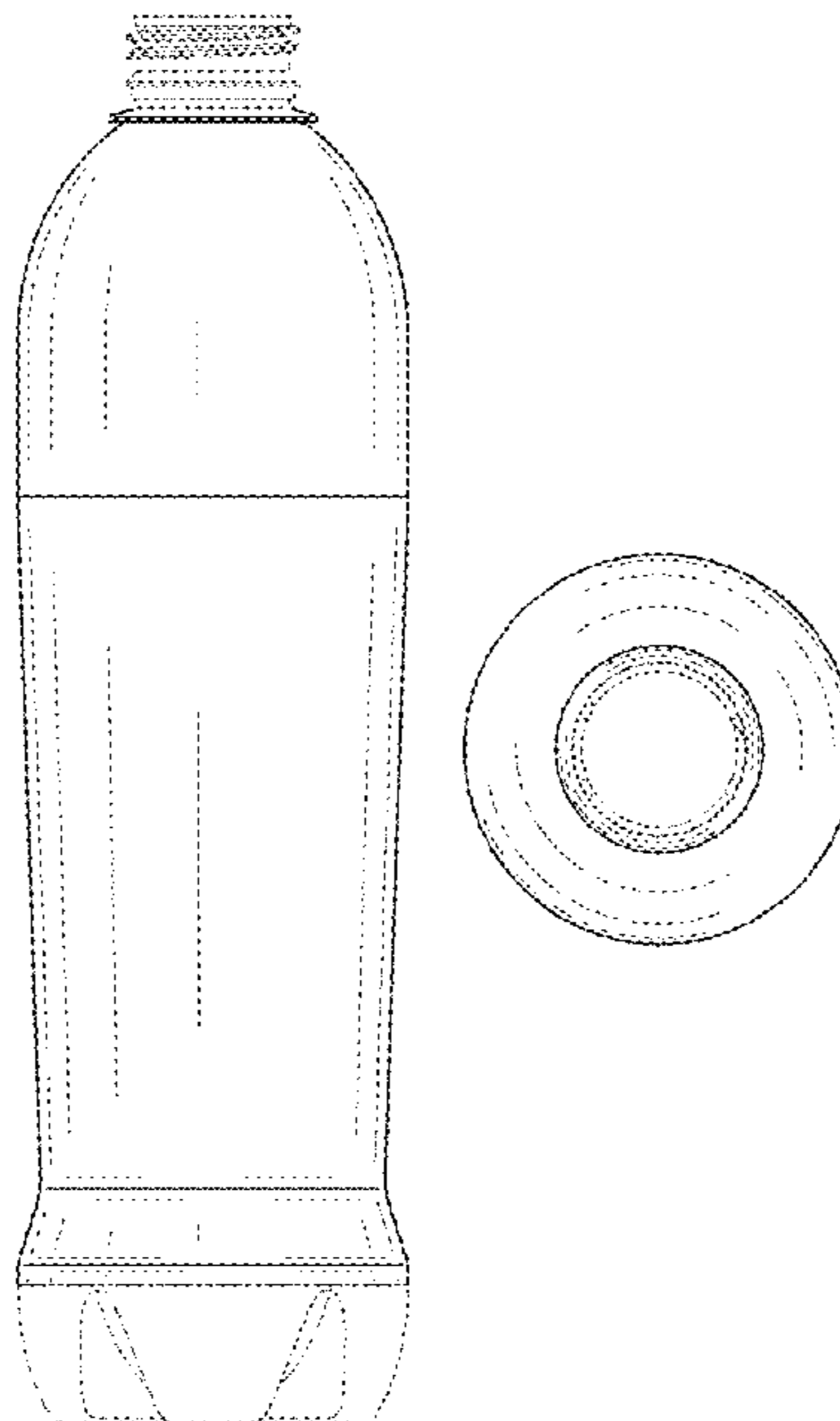

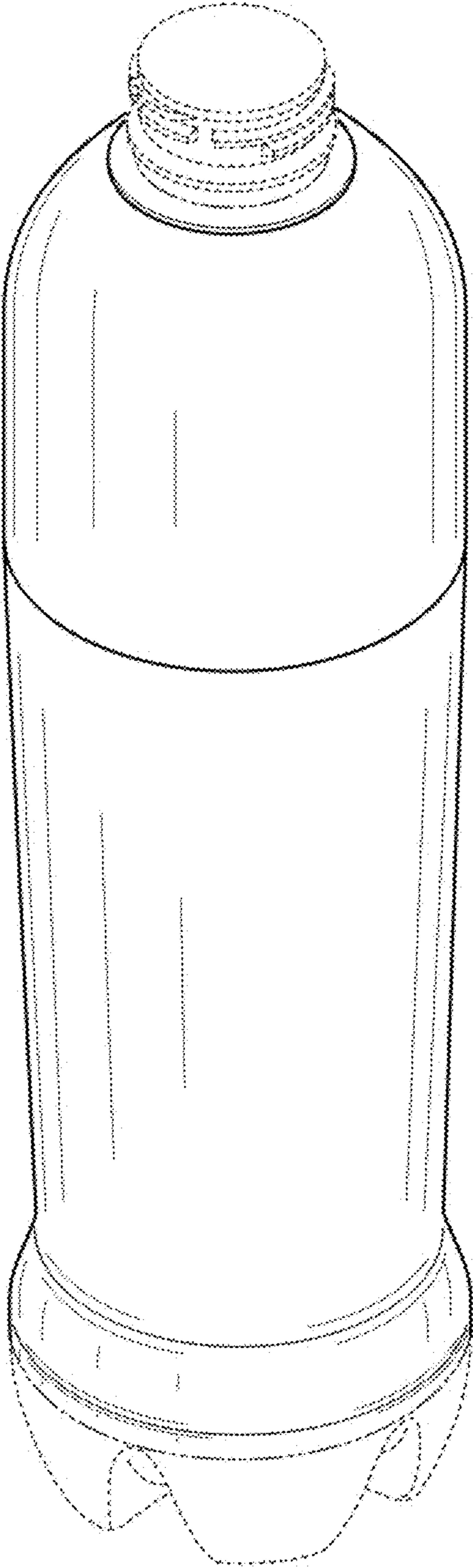

FIG. 1

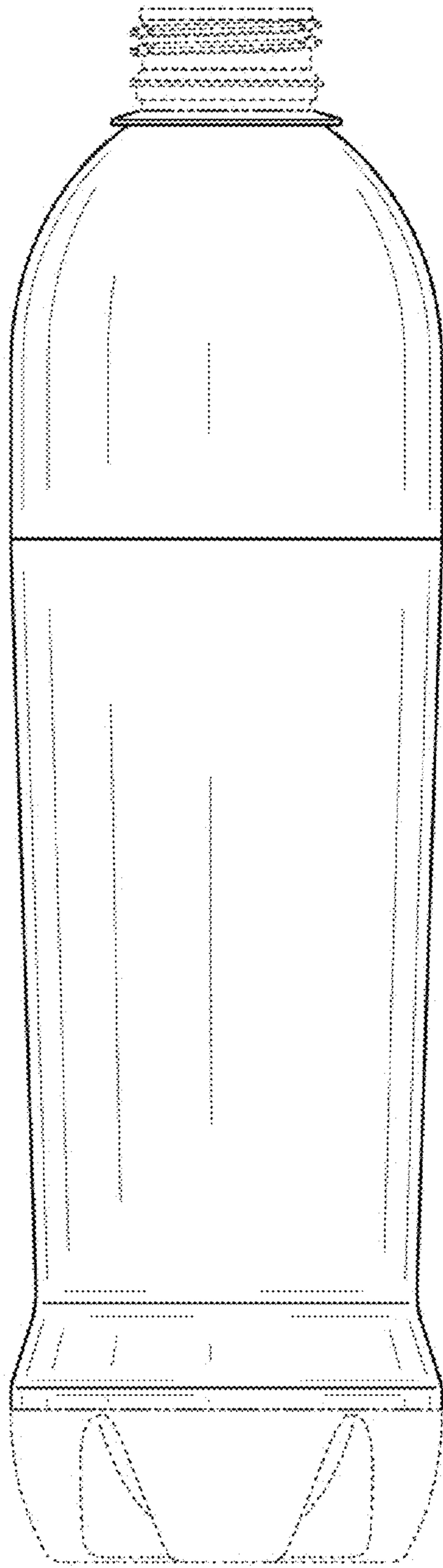

FIG. 2

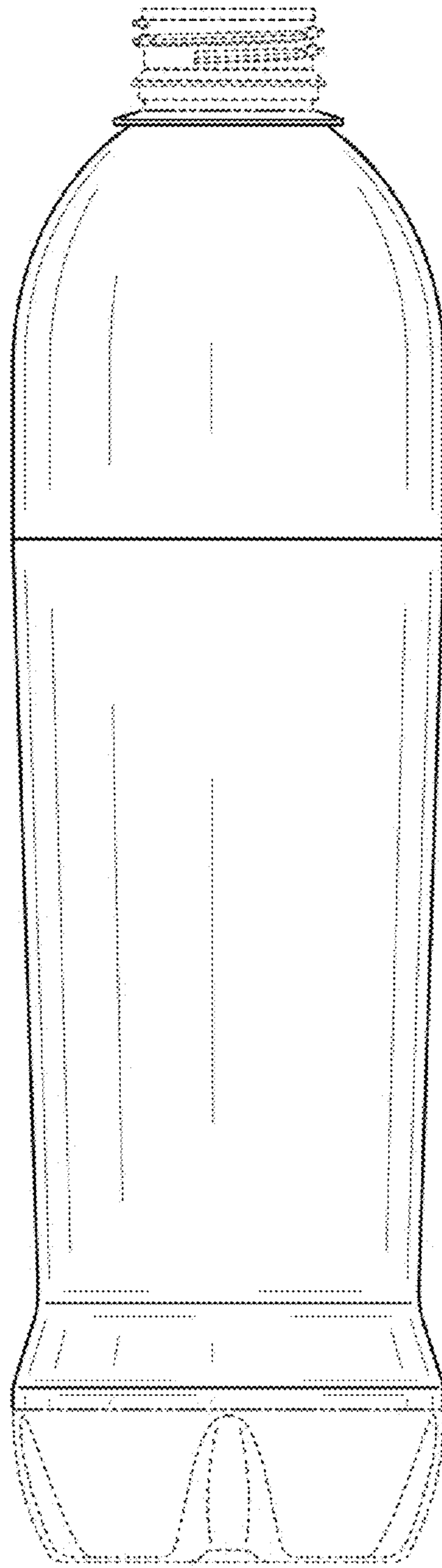

FIG. 3

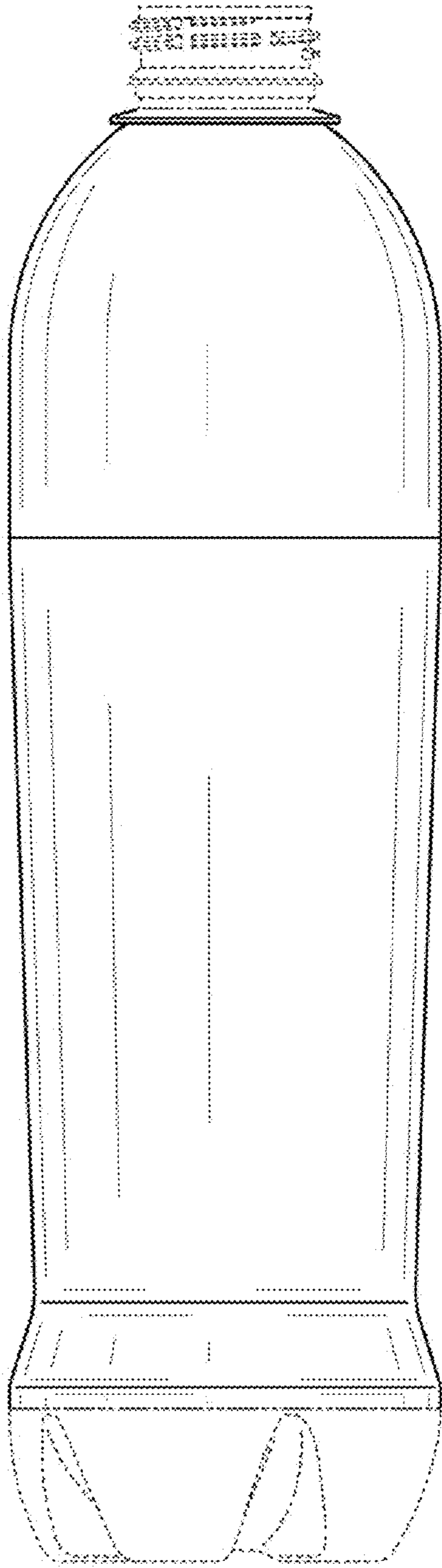

FIG. 4

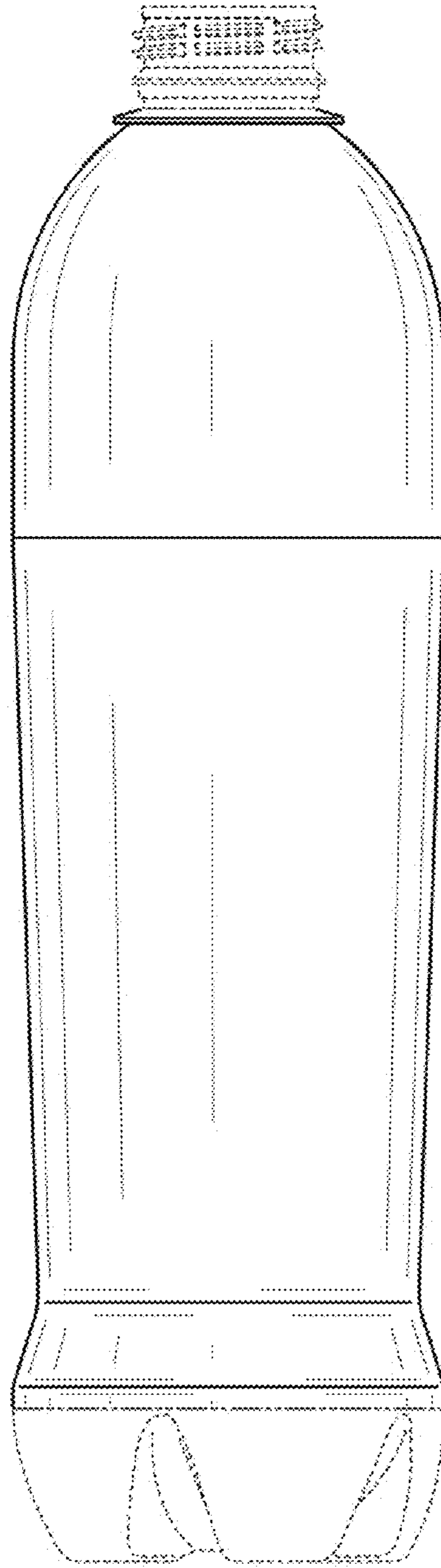

FIG. 5

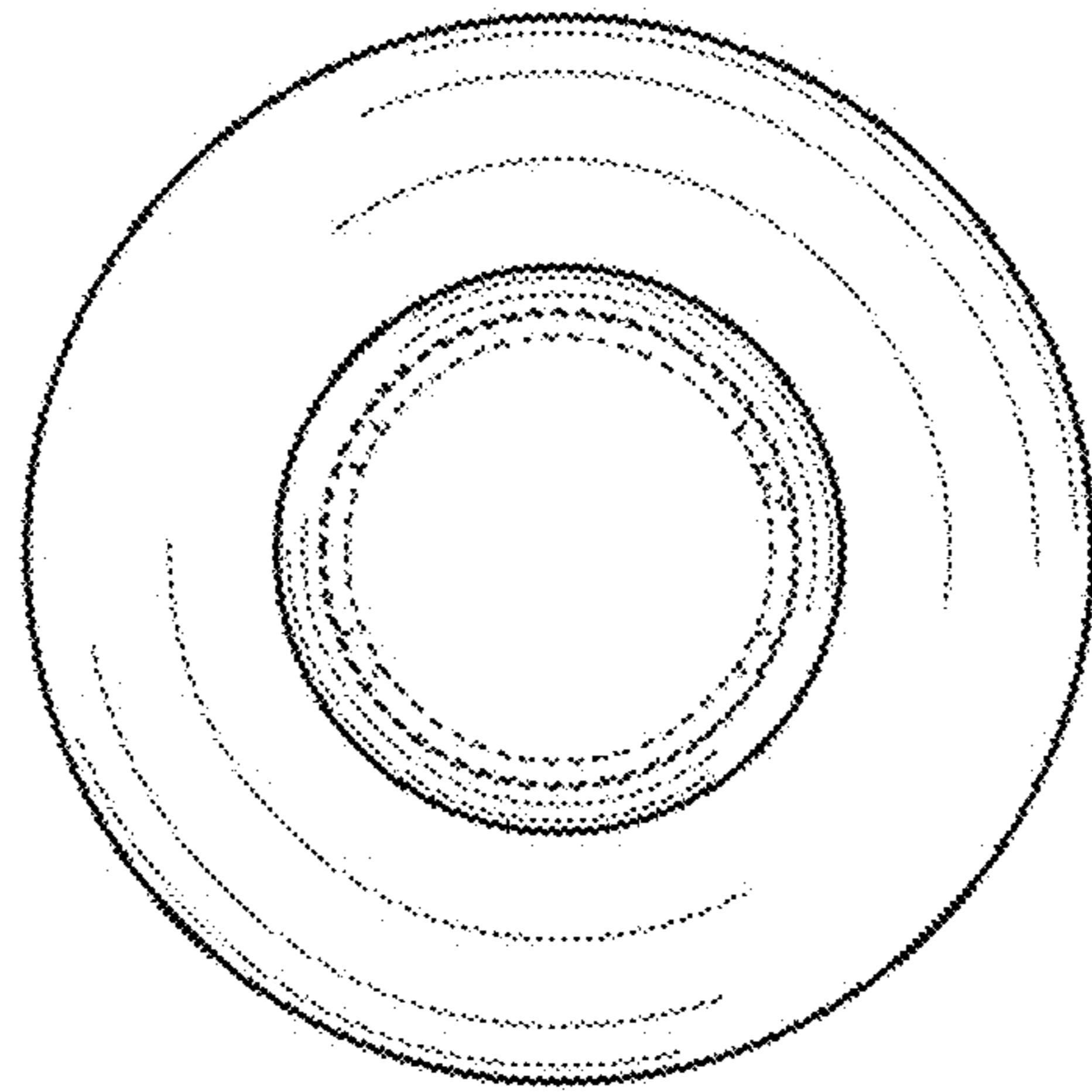

FIG. 6

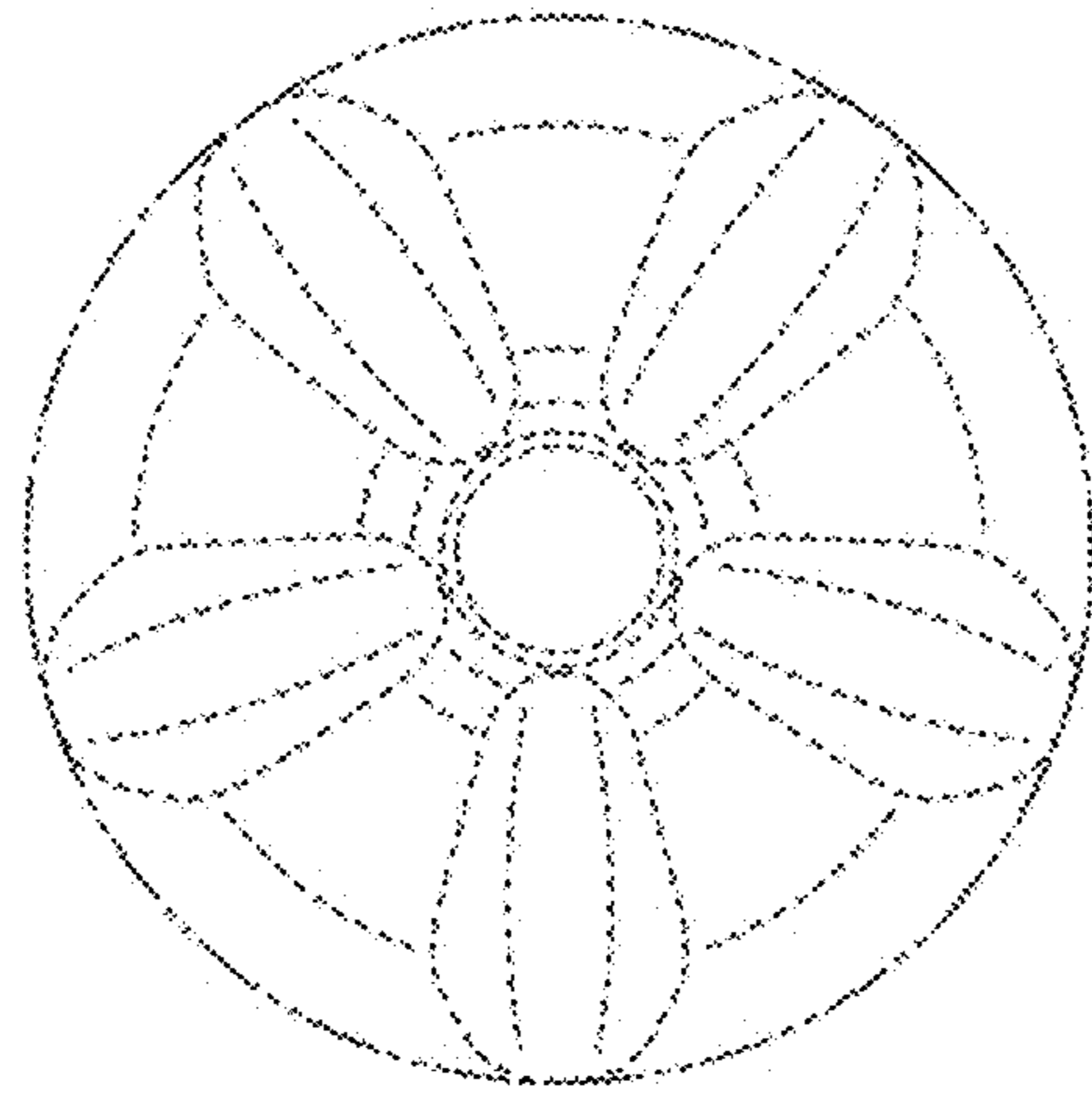

FIG. 7