

US00D736515S

(12) **United States Design Patent**  
**Chaklos**

(10) **Patent No.:** **US D736,515 S**

(45) **Date of Patent:** **\*\* Aug. 18, 2015**

(54) **UMBRELLA**

(71) Applicant: **Mike Chaklos**, Irvine, CA (US)

(72) Inventor: **Mike Chaklos**, Irvine, CA (US)

(\*\*) Term: **14 Years**

(21) Appl. No.: **29/504,052**

(22) Filed: **Oct. 1, 2014**

(51) **LOC (10) Cl.** ..... **03-03**

(52) **U.S. Cl.**  
USPC ..... **D3/5**

(58) **Field of Classification Search**

USPC ..... D3/5, 6, 10; 160/53; 446/246; 135/132,  
135/126, 133, 130, 123, 117, 25.33, 98,  
135/910, 137, 16; 403/86; 248/530  
CPC ..... E04F 10/04; A63H 13/20; E04H 15/38;  
E04H 15/40; E04H 15/003; E04H 15/18;  
E04H 15/32; E04H 15/28; A45B 19/10;  
A45B 3/04; A45B 3/00; A47C 29/006;  
G05G 7/12; A01K 97/10

See application file for complete search history.

(56) **References Cited**

**U.S. PATENT DOCUMENTS**

|           |     |         |              |       |         |
|-----------|-----|---------|--------------|-------|---------|
| 820,261   | A * | 5/1906  | Russell      | ..... | 160/53  |
| 1,615,663 | A * | 1/1927  | Varga        | ..... | 446/246 |
| D93,183   | S * | 8/1934  | Roth         | ..... | D3/5    |
| 2,006,655 | A * | 7/1935  | Roth         | ..... | 135/132 |
| 2,266,853 | A * | 12/1941 | Dabney       | ..... | 135/126 |
| 2,441,109 | A * | 5/1948  | Carlson      | ..... | 403/86  |
| 2,689,579 | A * | 9/1954  | Sartori      | ..... | 135/133 |
| 3,190,300 | A * | 6/1965  | Wear'N       | ..... | 135/126 |
| 3,386,456 | A * | 6/1968  | Walker       | ..... | 135/130 |
| D234,729  | S * | 4/1975  | Weber et al. | ..... | D3/10   |
| 4,098,281 | A * | 7/1978  | Bonfilio     | ..... | 135/130 |
| 4,355,650 | A * | 10/1982 | Beaudry      | ..... | 135/130 |
| 4,404,980 | A * | 9/1983  | Wade         | ..... | 135/123 |
| 4,739,784 | A * | 4/1988  | Fast         | ..... | 135/117 |
| D363,597  | S * | 10/1995 | Byrne        | ..... | D3/5    |
| 5,692,720 | A * | 12/1997 | Griggs       | ..... | 248/530 |

|           |      |         |                 |       |           |
|-----------|------|---------|-----------------|-------|-----------|
| D393,539  | S *  | 4/1998  | Bridgen         | ..... | D3/5      |
| 6,234,186 | B1 * | 5/2001  | Tsai            | ..... | 135/25.33 |
| D443,409  | S *  | 6/2001  | Pilz et al.     | ..... | D3/5      |
| 6,422,252 | B1 * | 7/2002  | Pilz et al.     | ..... | 135/98    |
| D475,524  | S *  | 6/2003  | Clarke          | ..... | D3/5      |
| 6,595,227 | B2 * | 7/2003  | Le Gette et al. | ..... | 135/126   |
| D478,416  | S *  | 8/2003  | Clarke          | ..... | D3/5      |
| 6,745,787 | B1 * | 6/2004  | Curtis          | ..... | 135/98    |
| D497,478  | S *  | 10/2004 | Clarke          | ..... | D3/5      |

(Continued)

**FOREIGN PATENT DOCUMENTS**

|    |                |   |         |
|----|----------------|---|---------|
| CA | 133272         | * | 6/2010  |
| CN | 301689261      | * | 10/2011 |
| EM | 001873548-0001 | * | 6/2011  |

**OTHER PUBLICATIONS**

Sport Brella \$59.95, Announced Mar. 14, 2010, [Site Visited Jun. 16, 2015] [http://www.shadeusa.com/sport\\_umbrella\\_blue.jpg](http://www.shadeusa.com/sport_umbrella_blue.jpg).\*

(Continued)

*Primary Examiner* — Eric Goodman

*Assistant Examiner* — Luqman McNeil

(74) *Attorney, Agent, or Firm* — Clement Cheng

(57) **CLAIM**

The ornamental design for an umbrella, as shown and described.

**DESCRIPTION**

- FIG. 1 is a front perspective view.
- FIG. 2 is a rear perspective view.
- FIG. 3 is a front view.
- FIG. 4 is a rear view.
- FIG. 5 is a left side view.
- FIG. 6 is a right side view.
- FIG. 7 is a top view.
- FIG. 8 is a bottom view; and,
- FIG. 9 is a standing side view.

**1 Claim, 9 Drawing Sheets**

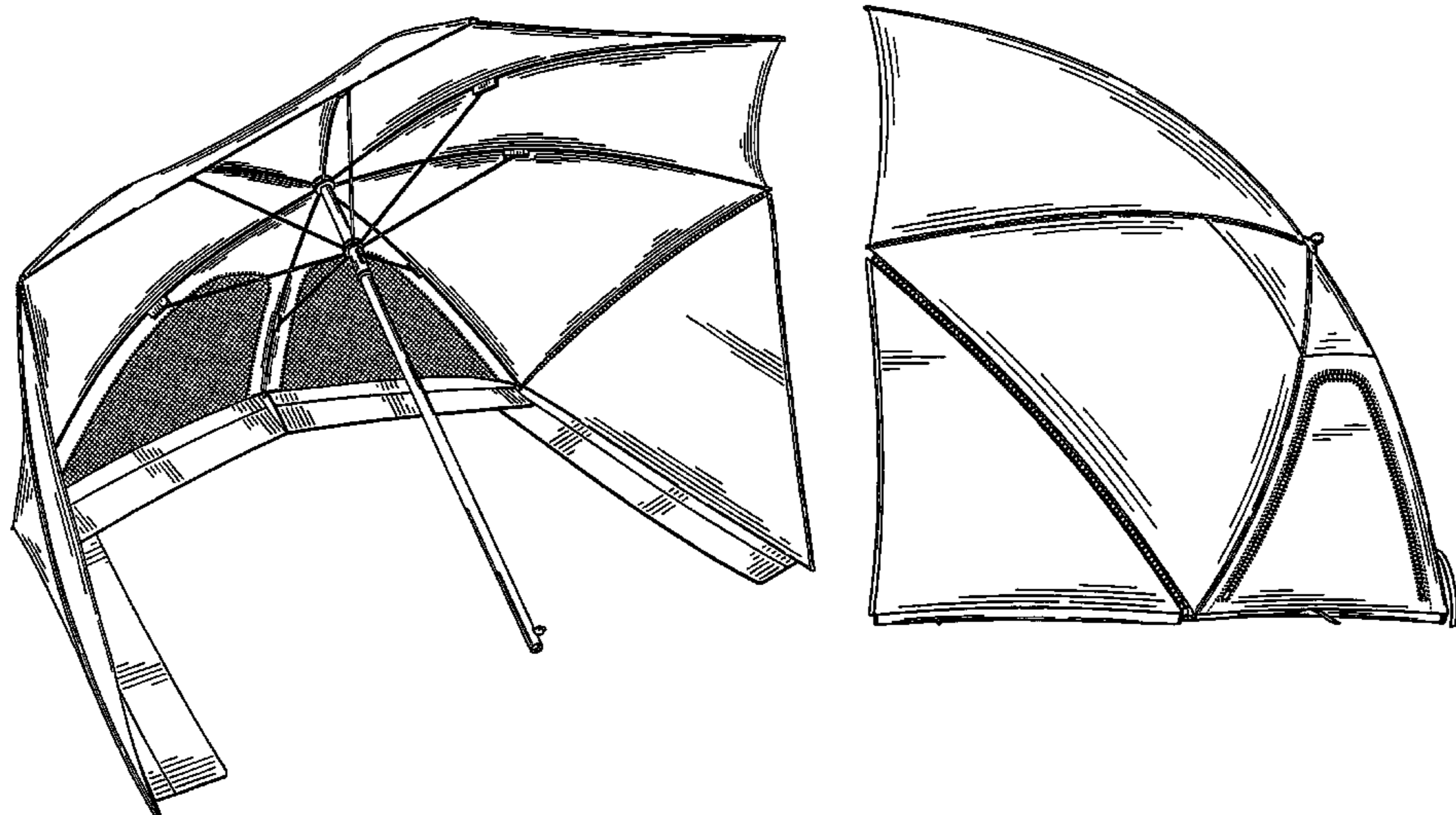

(56)

**References Cited**

U.S. PATENT DOCUMENTS

D503,036 S \* 3/2005 Di Cesare ..... D3/5  
D513,117 S \* 12/2005 Raede ..... D3/5  
D521,229 S \* 5/2006 Mariano ..... D3/5  
7,316,239 B2 \* 1/2008 Yang ..... 135/137  
D587,447 S \* 3/2009 You ..... D3/5  
D599,103 S \* 9/2009 Hoogendoorn et al. .... D3/5  
D627,148 S \* 11/2010 Quinn ..... D3/5  
D627,553 S \* 11/2010 Elder ..... D3/5  
D627,554 S \* 11/2010 Elder ..... D3/5  
D627,555 S \* 11/2010 Elder ..... D3/5  
D664,760 S \* 8/2012 Elder ..... D3/5  
D664,761 S \* 8/2012 Horowitz ..... D3/6

8,371,322 B1 \* 2/2013 Wilson-Campbell ..... 135/133  
2005/0121063 A1 \* 6/2005 Chang ..... 135/910  
2009/0283120 A1 \* 11/2009 Varga et al. .... 135/16

OTHER PUBLICATIONS

Review of the Sport-Brella Umbrella, Portable Sun and Weather, Announced Jul. 7, 2013, [ Site Visited Jun. 16, 2015 ] <http://beachtentstore.com/sport-brella-umbrella-portable-sun-and-weather-shelter/>.\*  
Sport Brella Portable Sun and Weather, Announced Jul. 15, 2011, [Site Visited Jun. 16, 2015] <http://www.amazon.com/Sport-Brella-XL-Portable-Weather-Shelter/dp/B003DJ88J0>.\*

\* cited by examiner

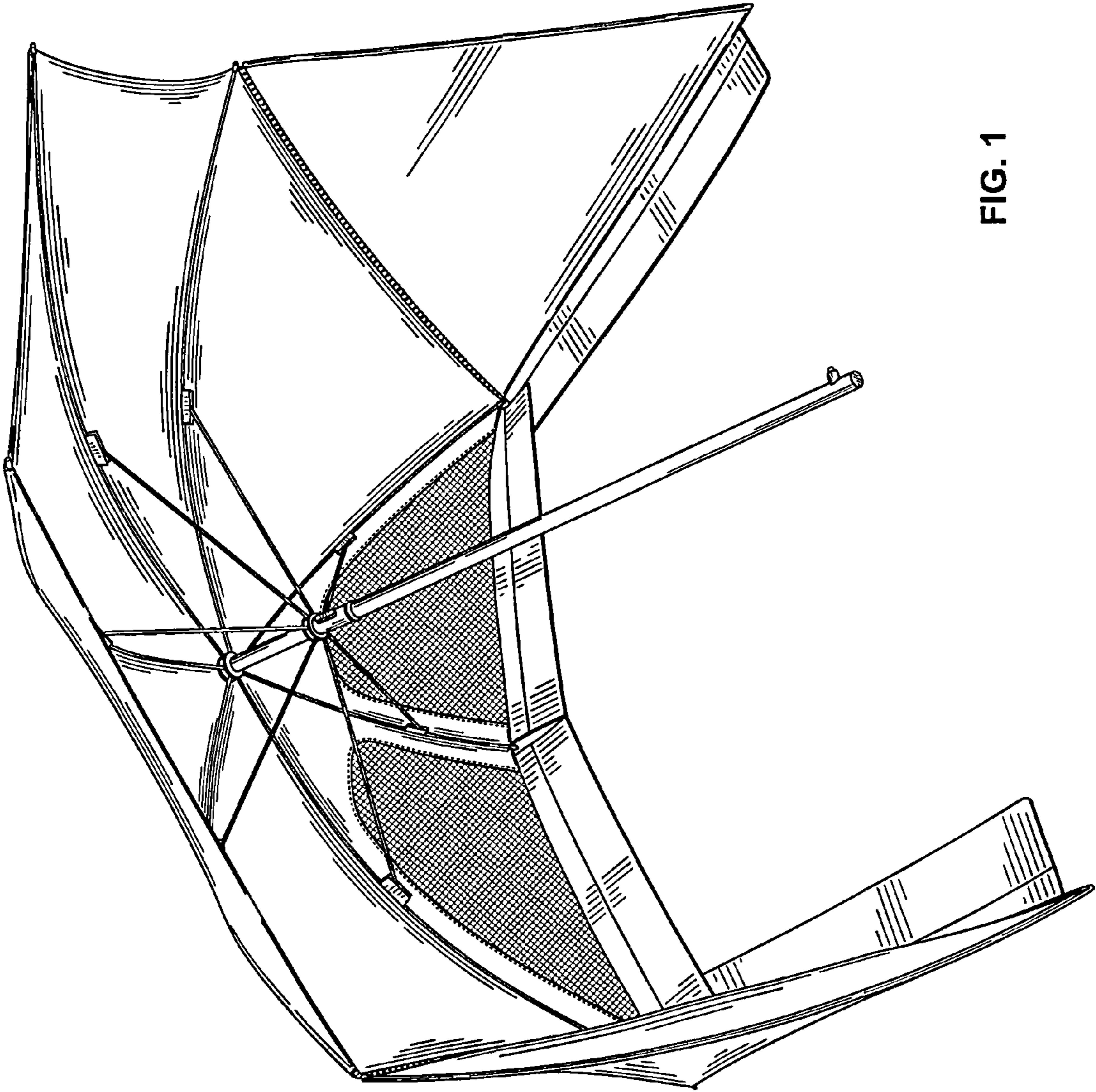

FIG. 1

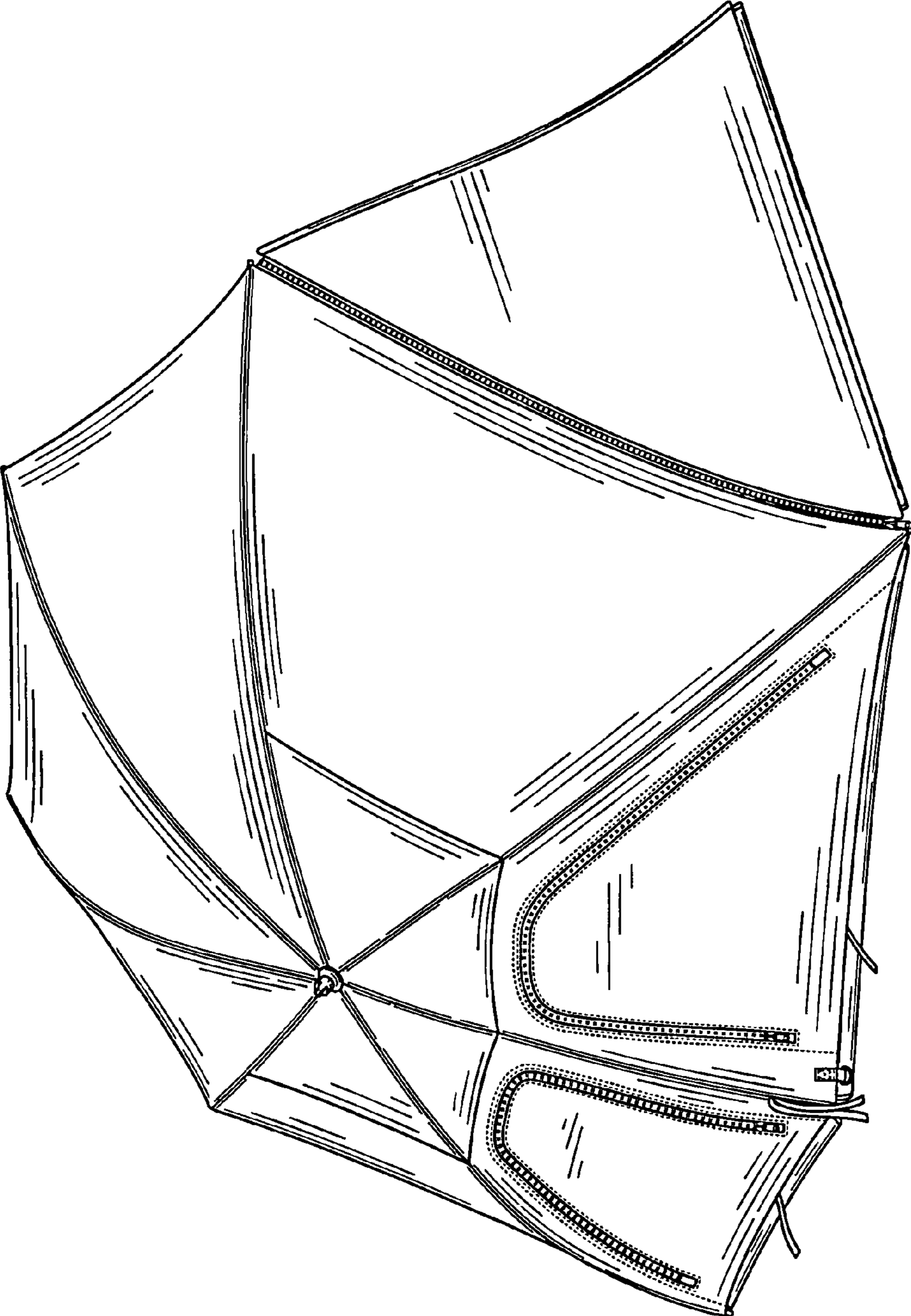

FIG. 2

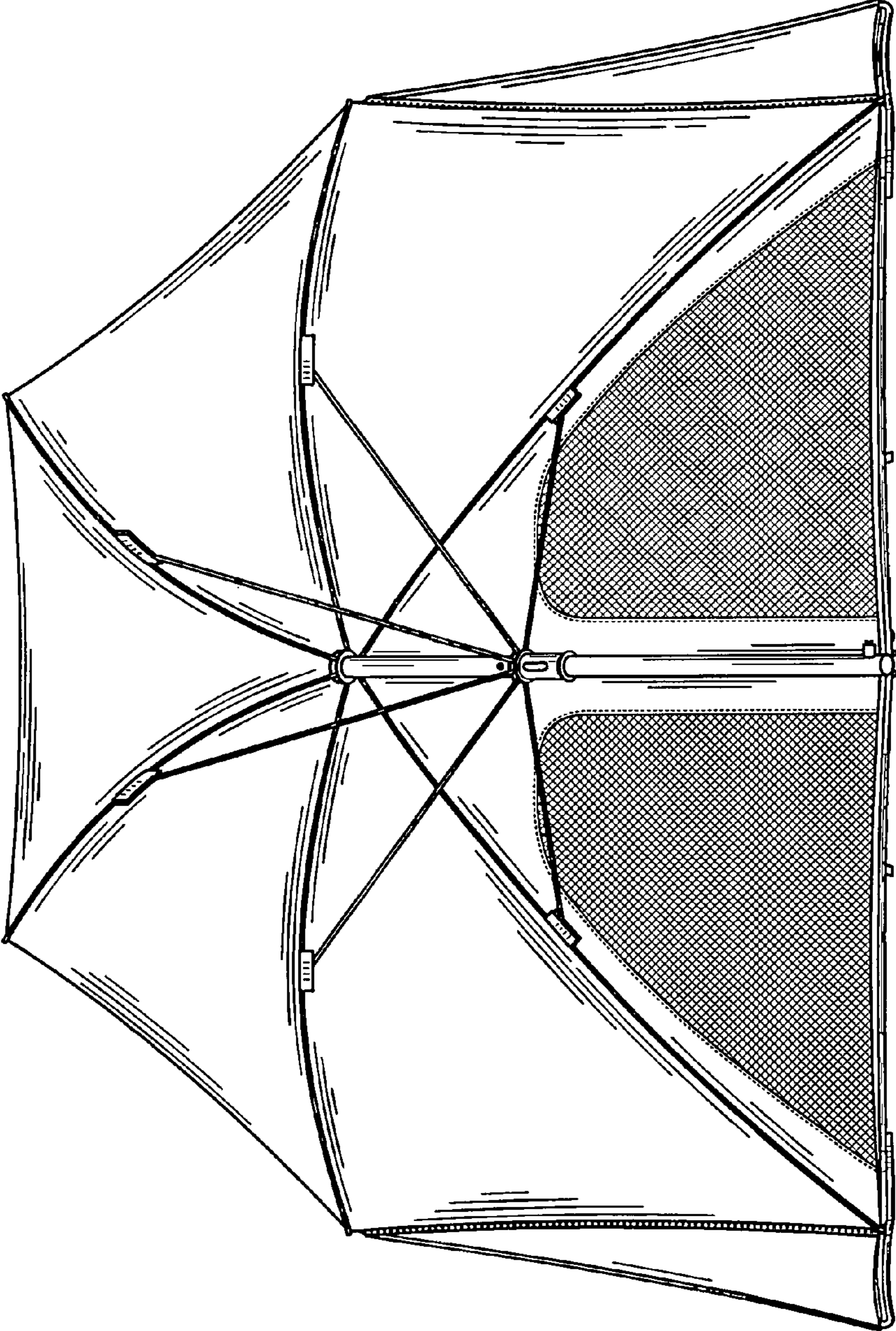

FIG. 3

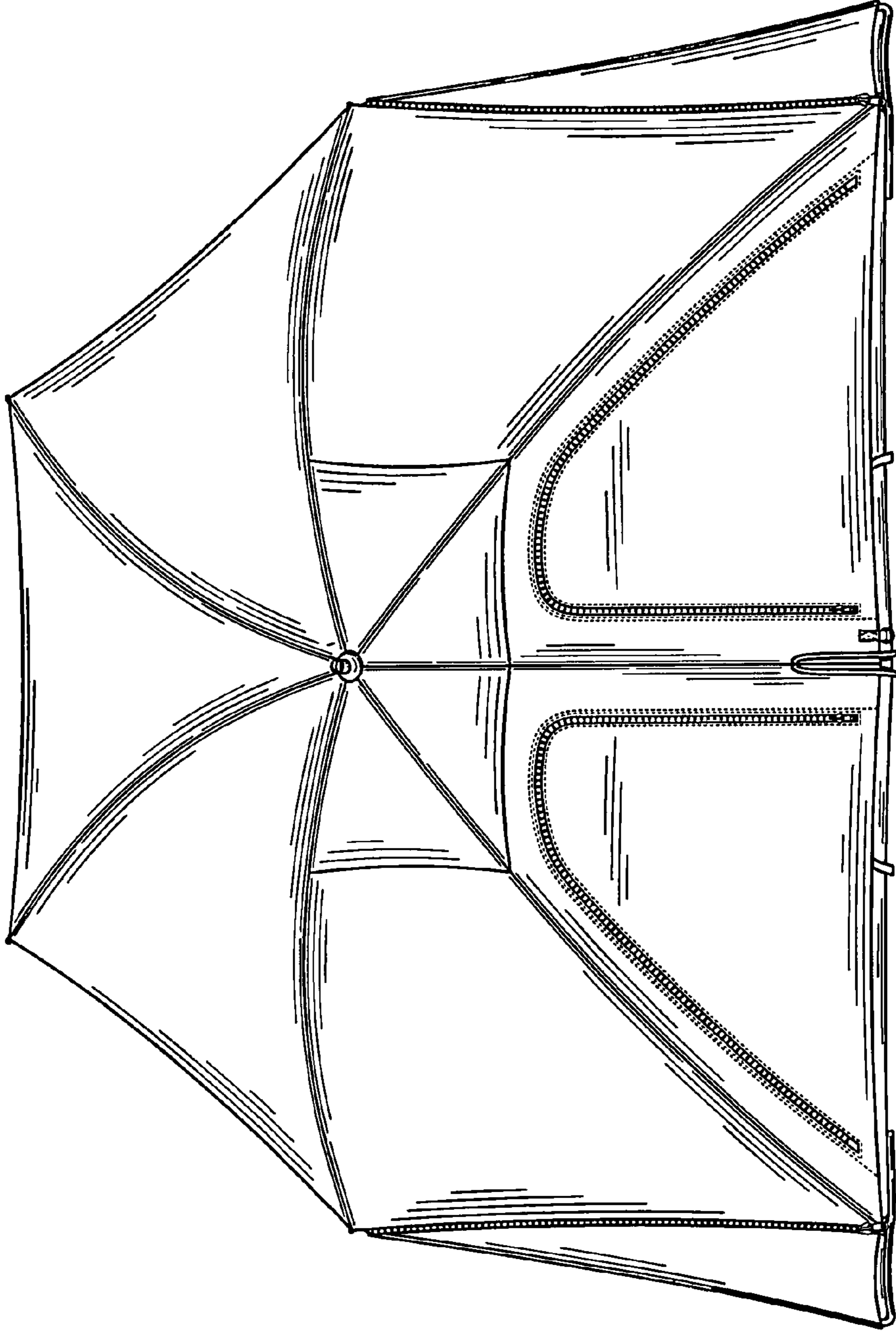

FIG. 4

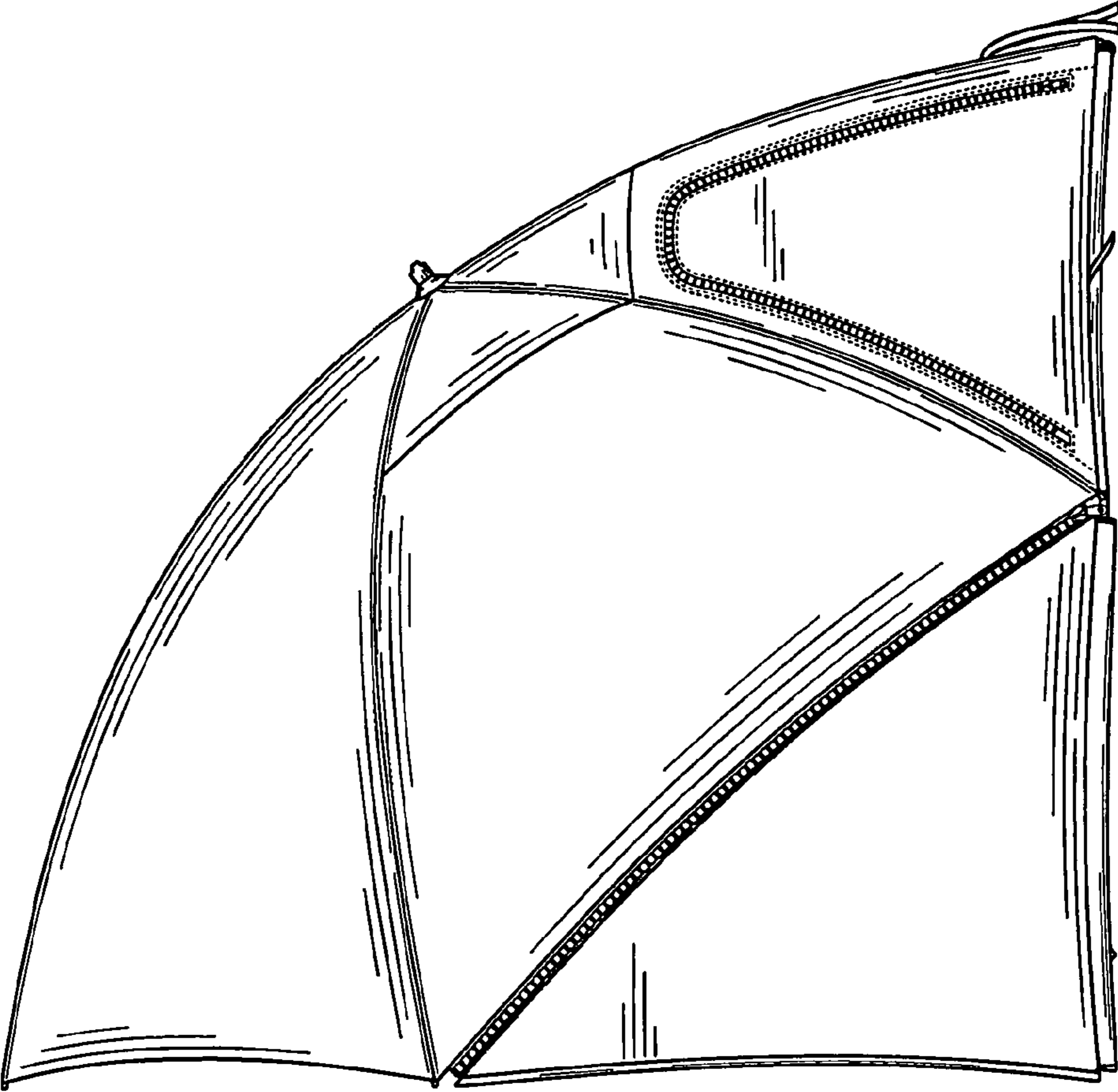

FIG. 5

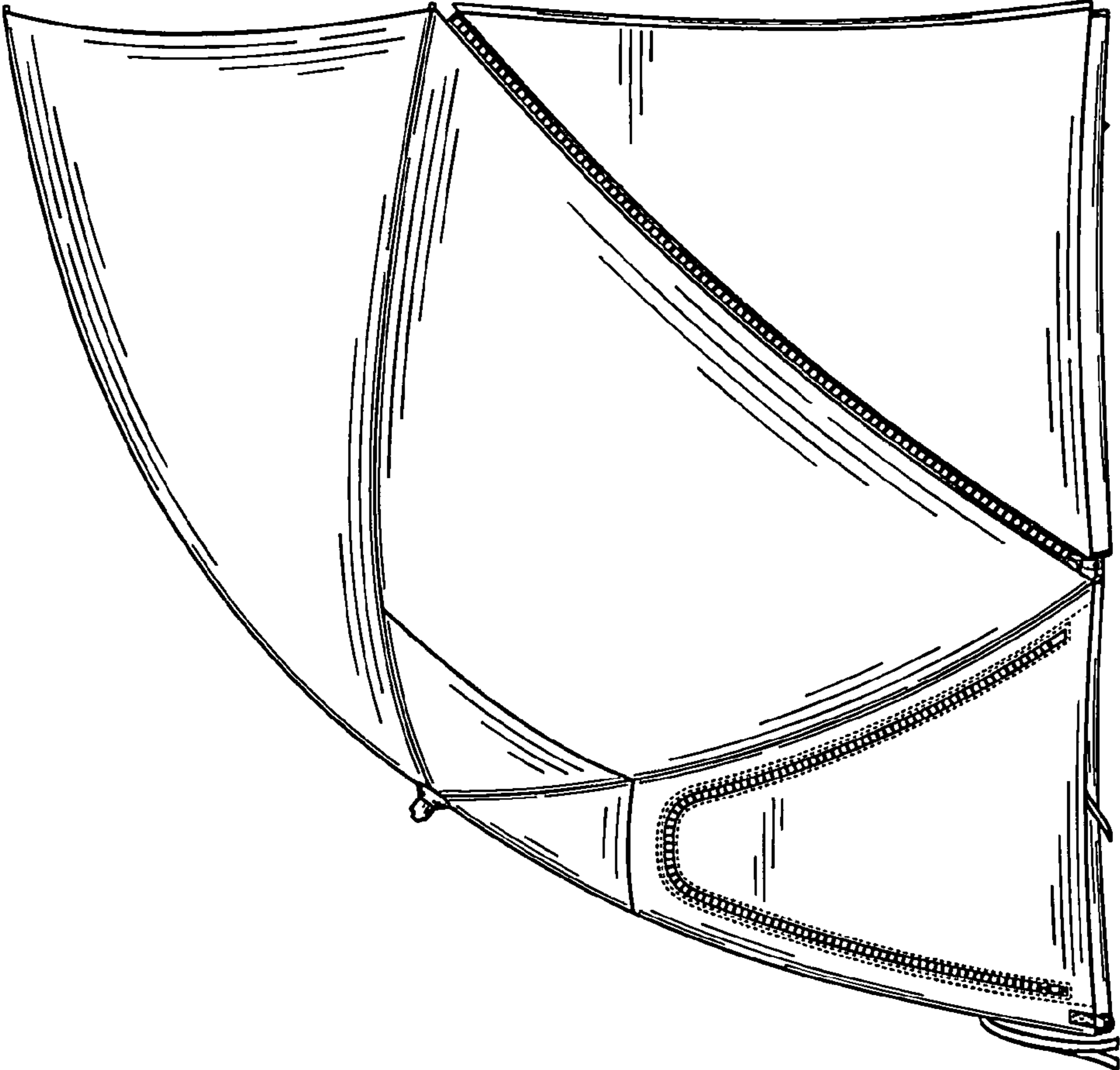

FIG. 6



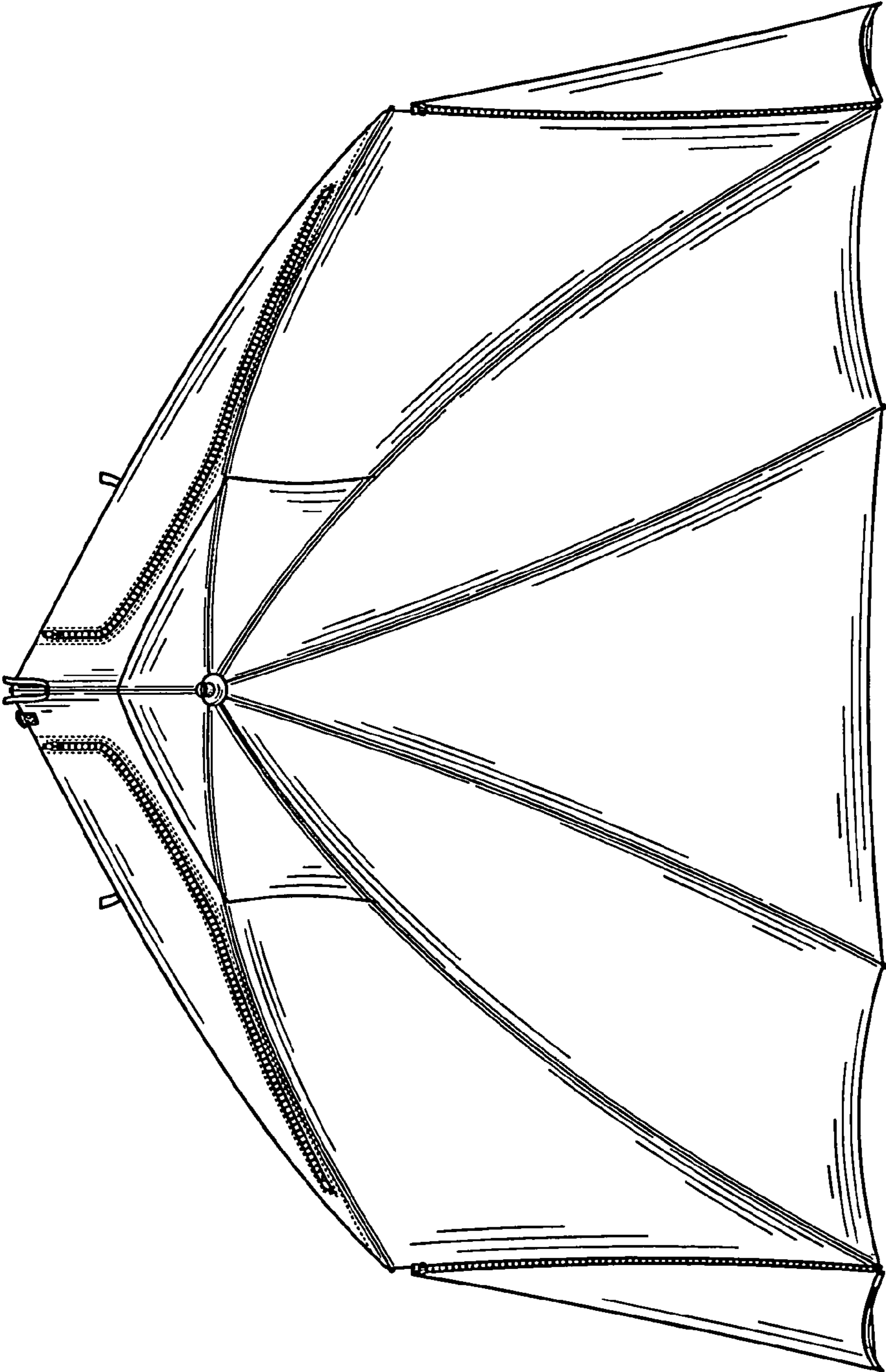

FIG. 7

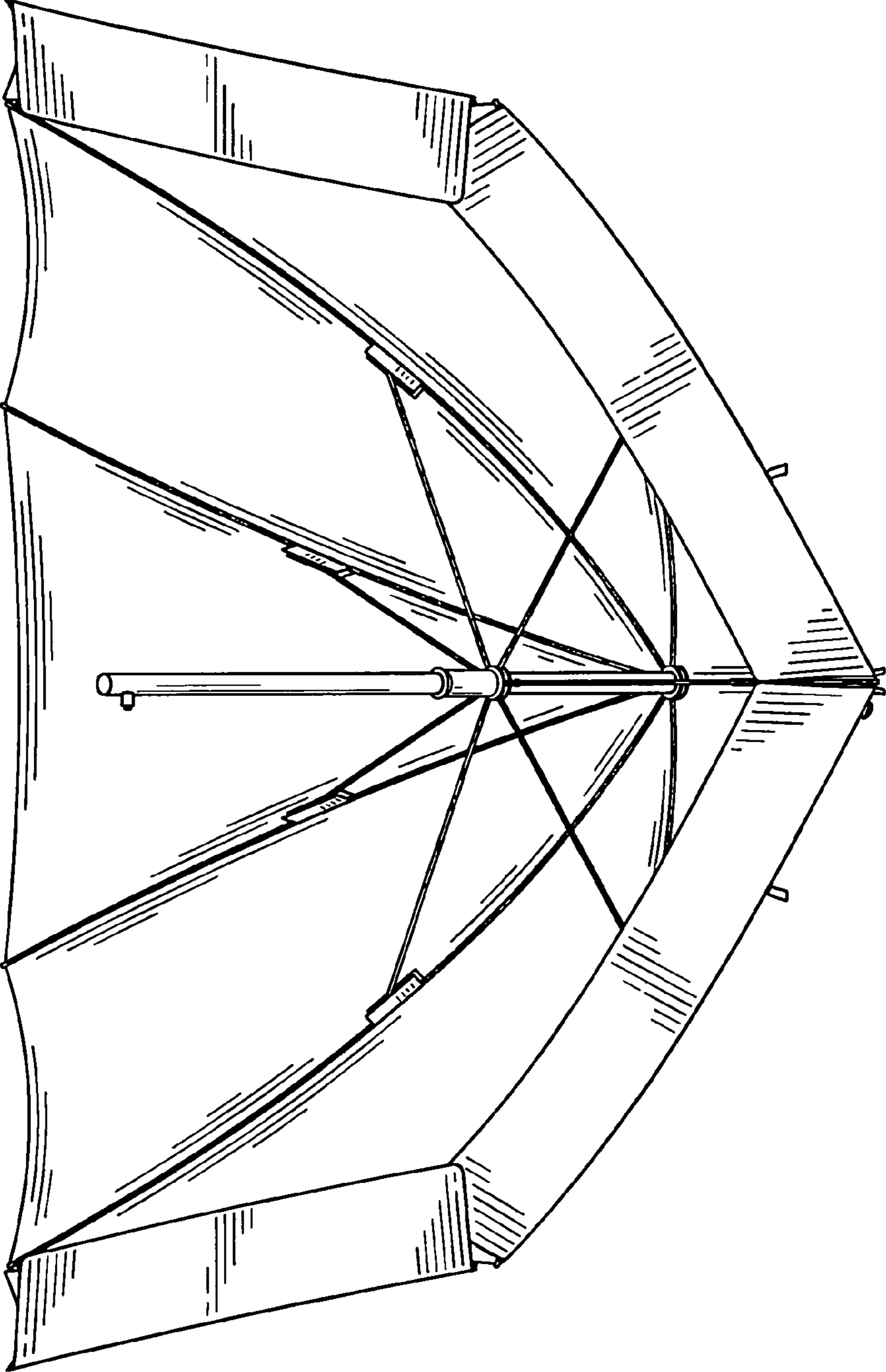

FIG. 8

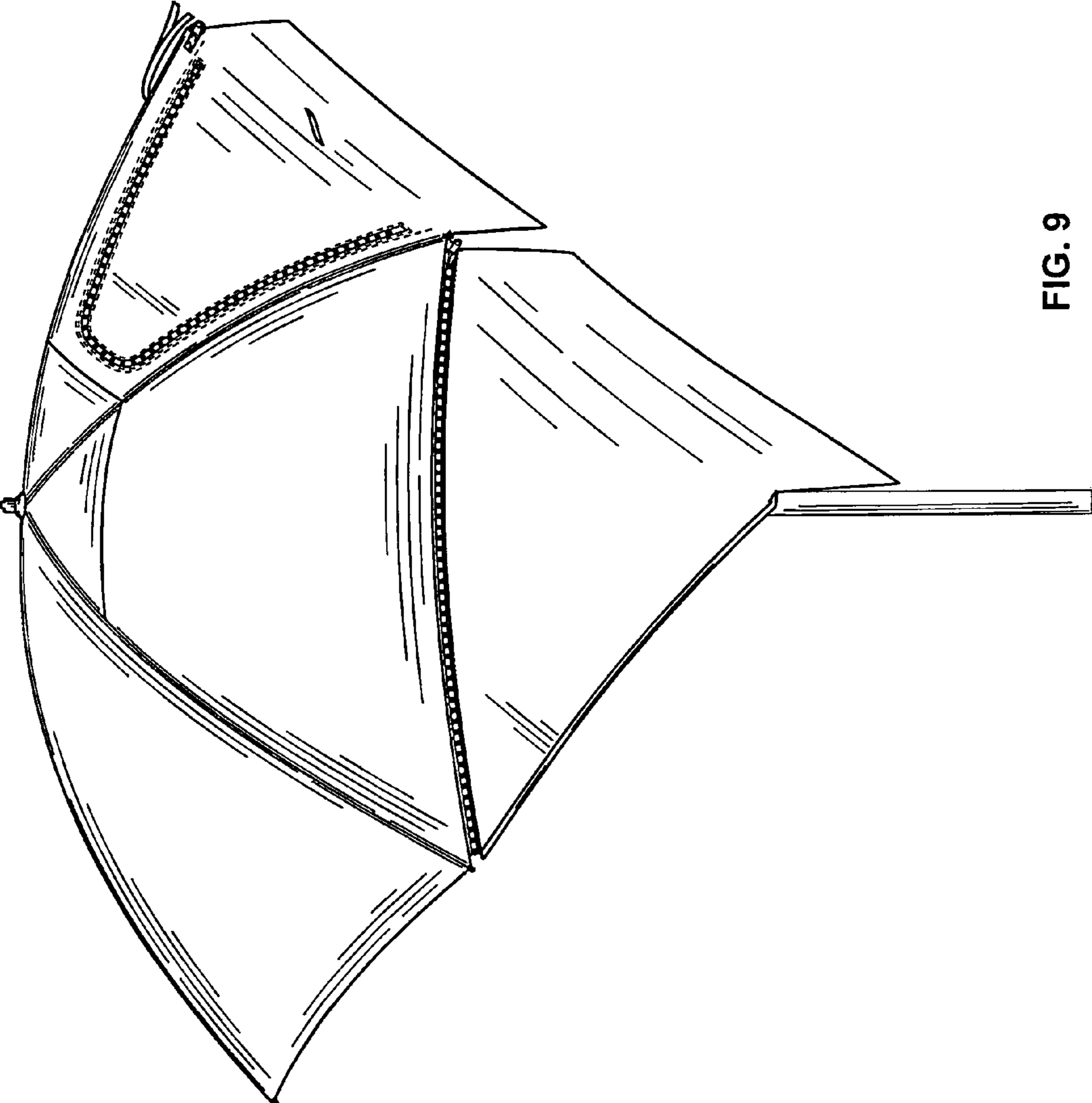

FIG. 9