



US00D736488S

(12) **United States Design Patent**
Le

(10) **Patent No.:** **US D736,488 S**

(45) **Date of Patent:** **** Aug. 11, 2015**

(54) **DOME DRYING RACK**

(71) Applicant: **Johannes Le**, Huntington Beach, CA
(US)

(72) Inventor: **Johannes Le**, Huntington Beach, CA
(US)

(73) Assignee: **CAMBRO MANUFACTURING
COMPANY**, Huntington Beach, CA
(US)

(**) Term: **14 Years**

(21) Appl. No.: **29/492,967**

(22) Filed: **Jun. 4, 2014**

(51) **LOC (10) Cl.** **07-05**

(52) **U.S. Cl.**
USPC **D32/55**

(58) **Field of Classification Search**
USPC D32/55, 276, 3; D6/510, 525; D30/133;
211/41.5, 41.4, 41.3, 41.8; 361/679.4;
312/311, 333, 334.4; D7/354, 629
CPC A47J 47/20; A47J 2201/00; A47J 47/00;
B65D 35/02; B65D 35/22; B65D 35/56
See application file for complete search history.

(56) **References Cited**

U.S. PATENT DOCUMENTS

1,889,146 A * 11/1932 Kalenoff 220/23.8
3,027,041 A * 3/1962 Stansbury, Jr. et al. 220/572

D369,002 S * 4/1996 Pratt D32/55
D383,273 S * 9/1997 Hampshire D32/55
D418,646 S * 1/2000 Hampshire D32/55
D492,457 S * 6/2004 Soroka D32/55
D581,619 S * 11/2008 Yang et al. D32/55
D663,912 S * 7/2012 Le D32/55
D696,829 S * 12/2013 Huang D32/55
D706,008 S * 5/2014 Lerner D32/55
D720,109 S * 12/2014 Huang D32/55
D723,759 S * 3/2015 Evans et al. D32/55

* cited by examiner

Primary Examiner — Austin Murphy

(74) *Attorney, Agent, or Firm* — George F. Bethel

(57) **CLAIM**

I claim the ornamental design for a dome drying rack, as shown and described.

DESCRIPTION

FIG. 1 is a left frontal perspective view of the dome drying rack.
FIG. 2 is a left side elevation view thereof.
FIG. 3 is a front elevation view thereof.
FIG. 4 is a top plan view thereof.
FIG. 5 is a bottom plan view thereof.
FIG. 6 is a right side elevation view thereof.
FIG. 7 is a rear elevation view thereof; and,
FIG. 8 is a left frontal perspective view with food cover domes in a dotted configuration for showing the environment of the dome drying rack.

1 Claim, 6 Drawing Sheets

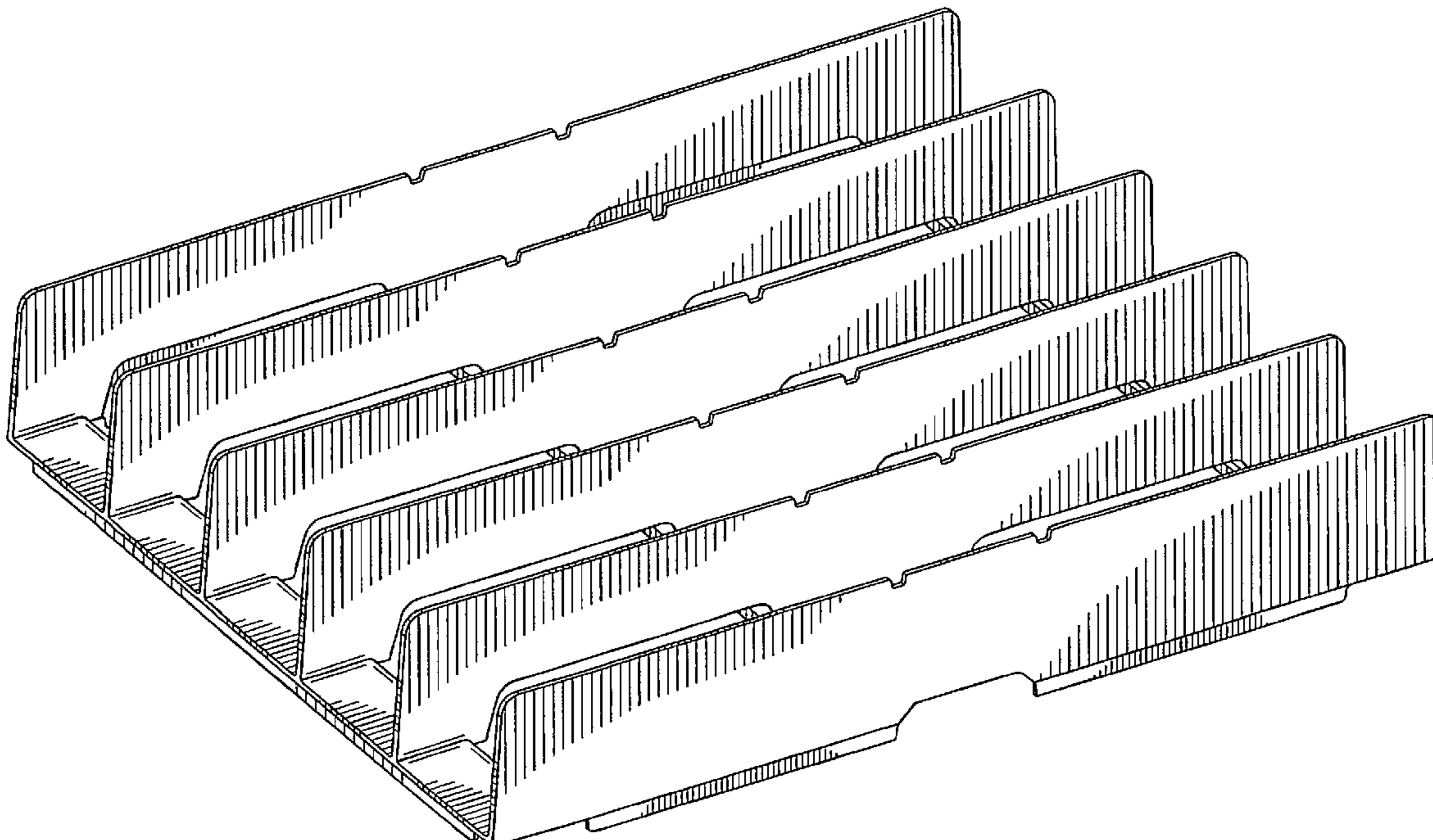

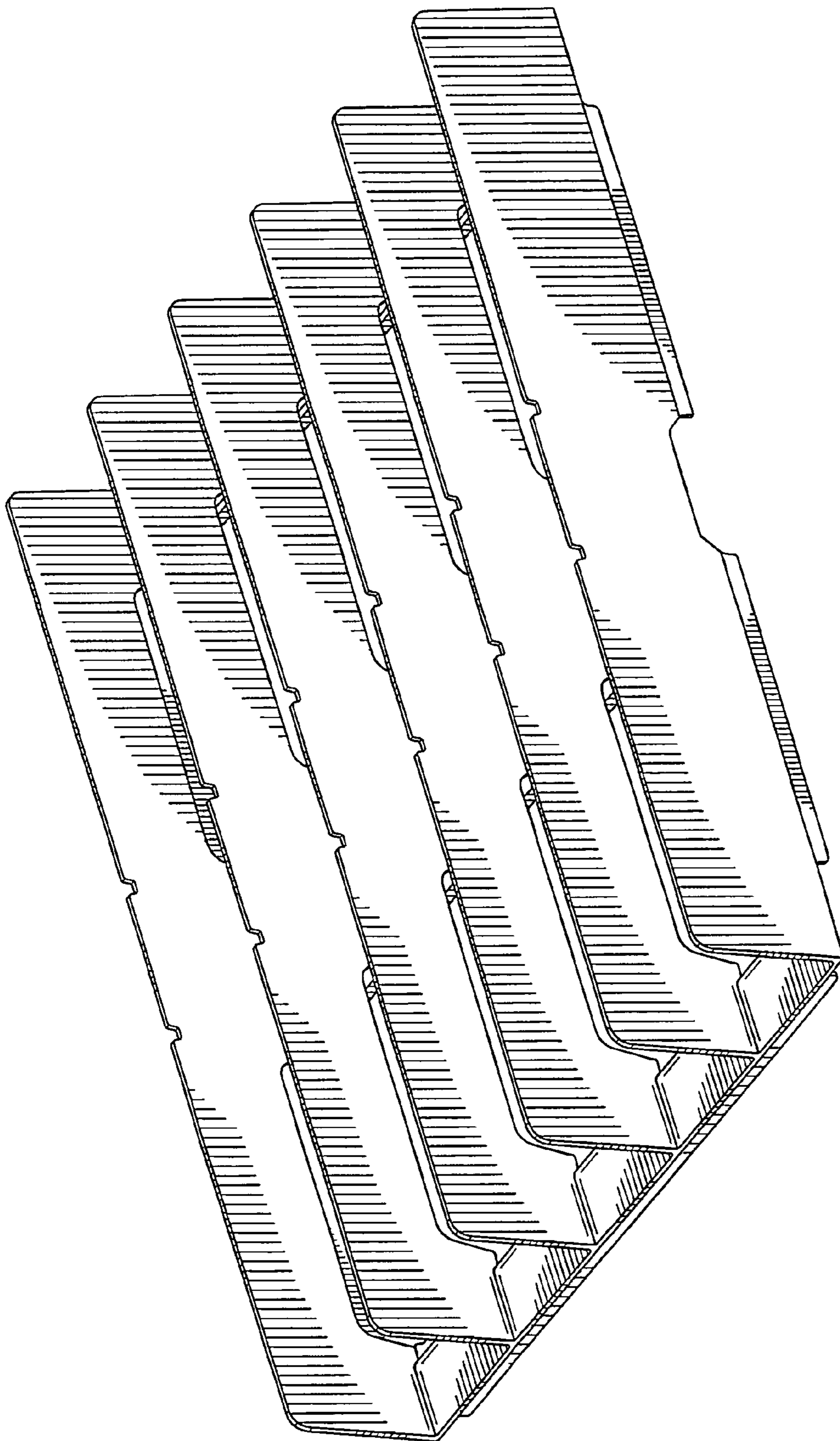

FIG. 1

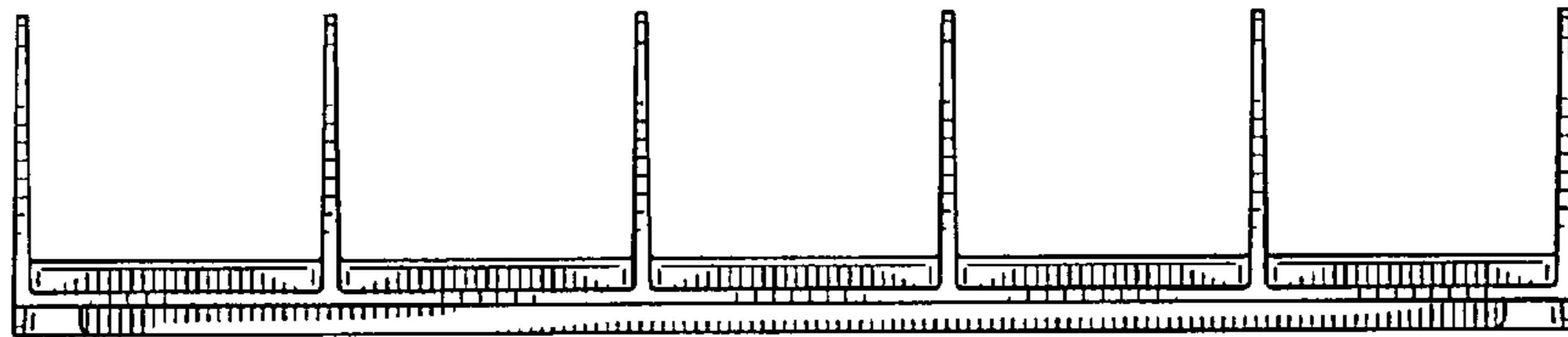

FIG. 2

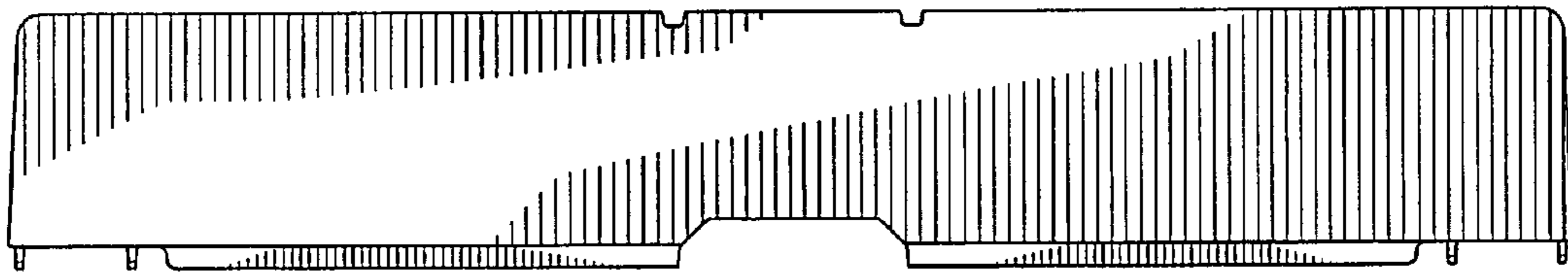

FIG. 3

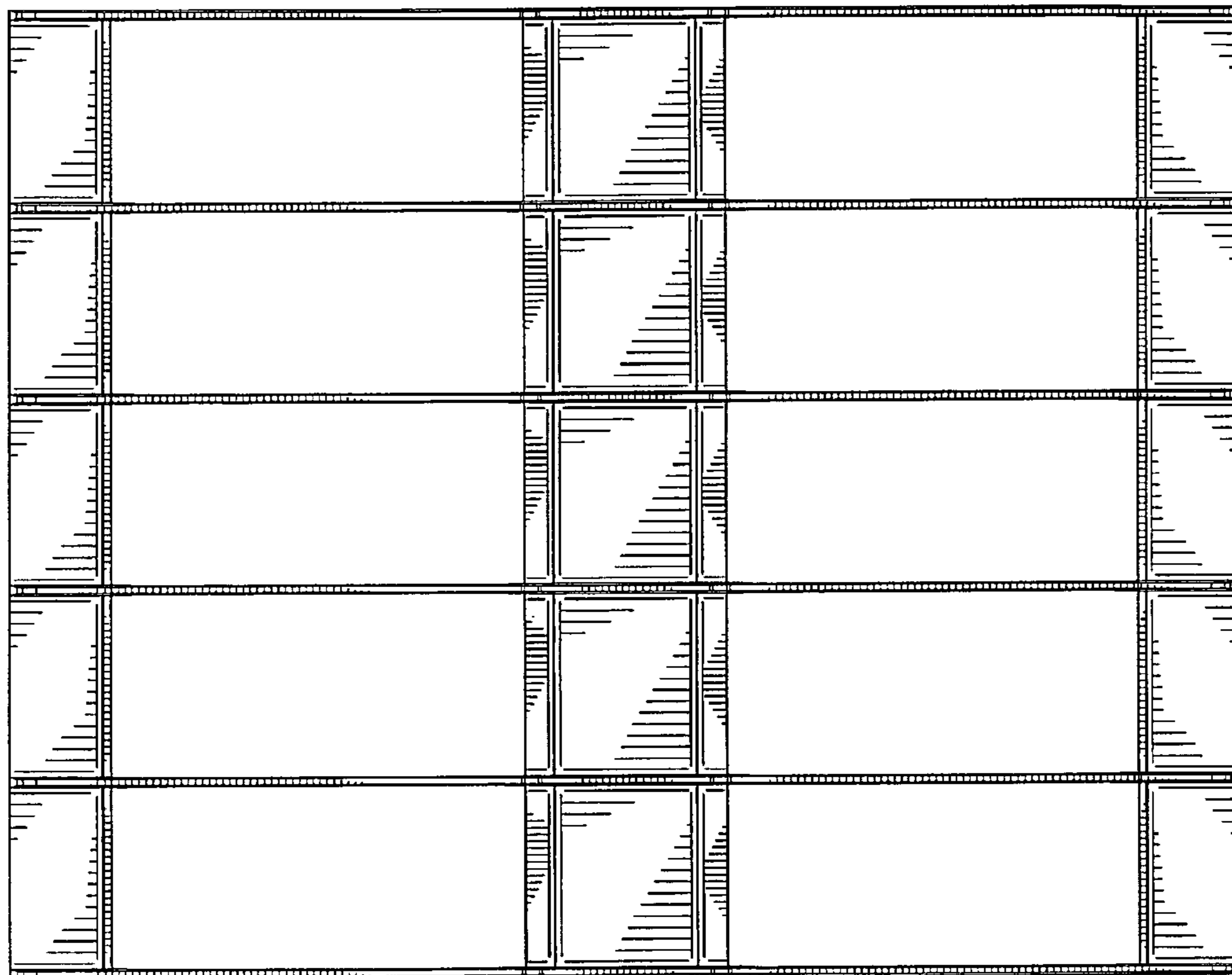

FIG. 4

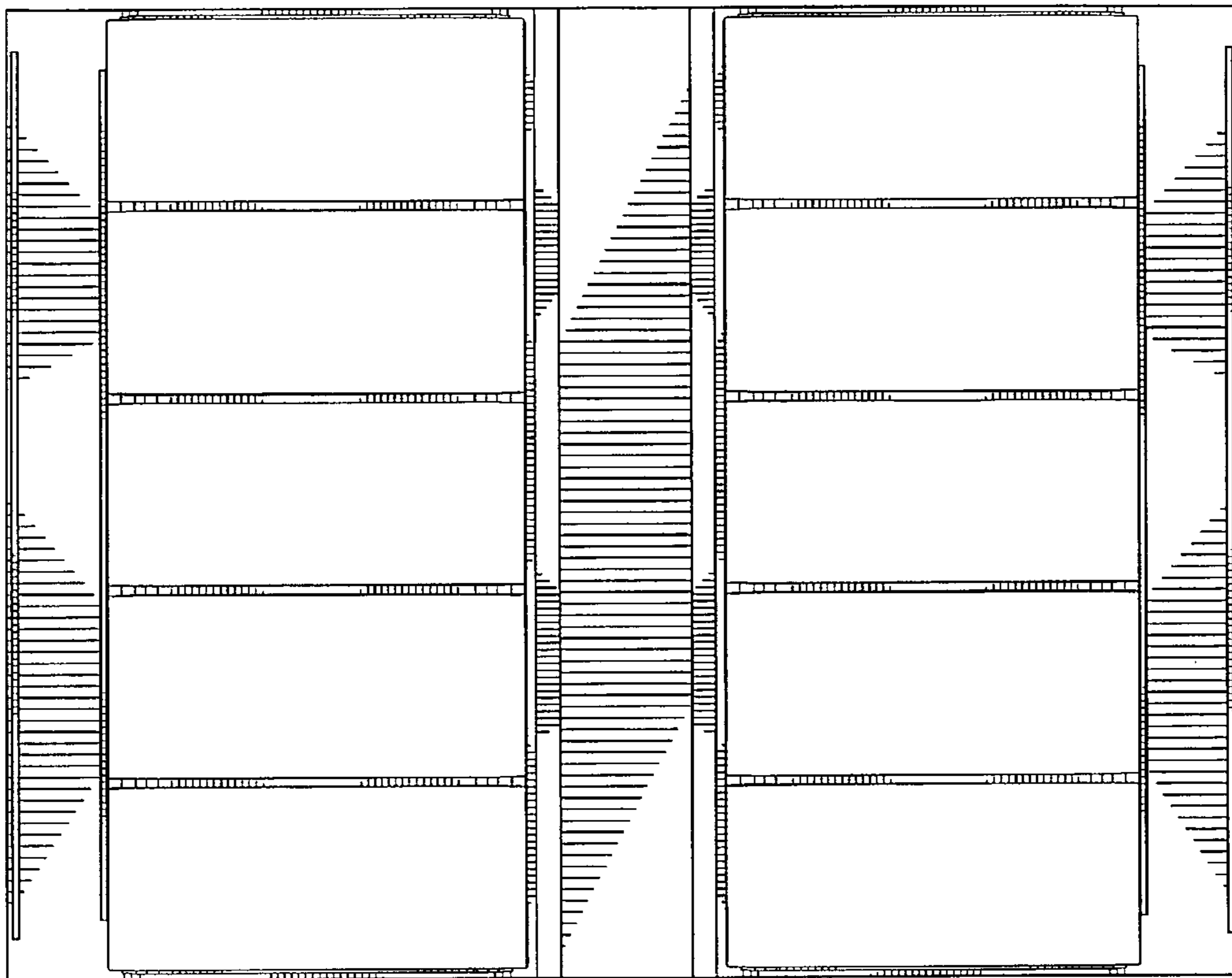

FIG. 5

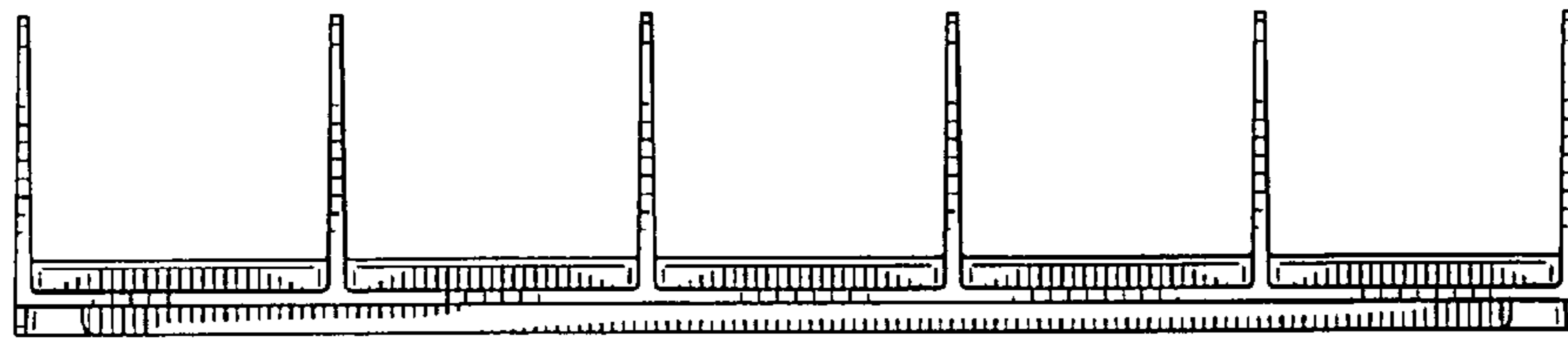

FIG. 6

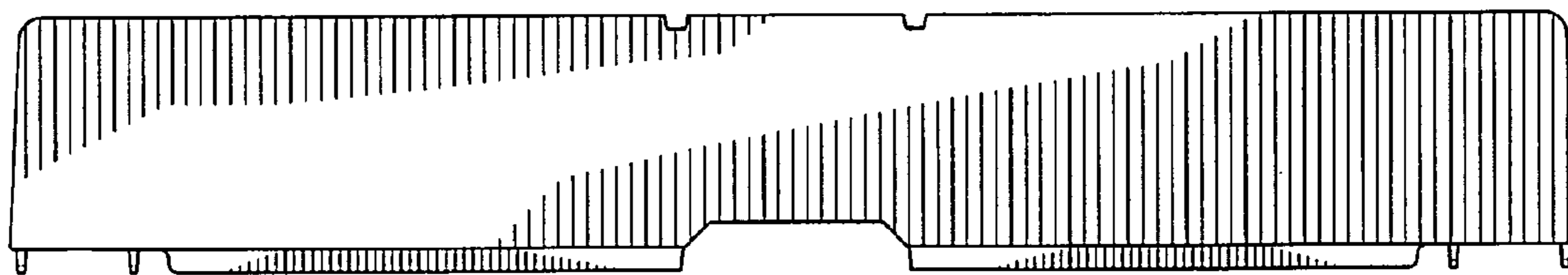

FIG. 7

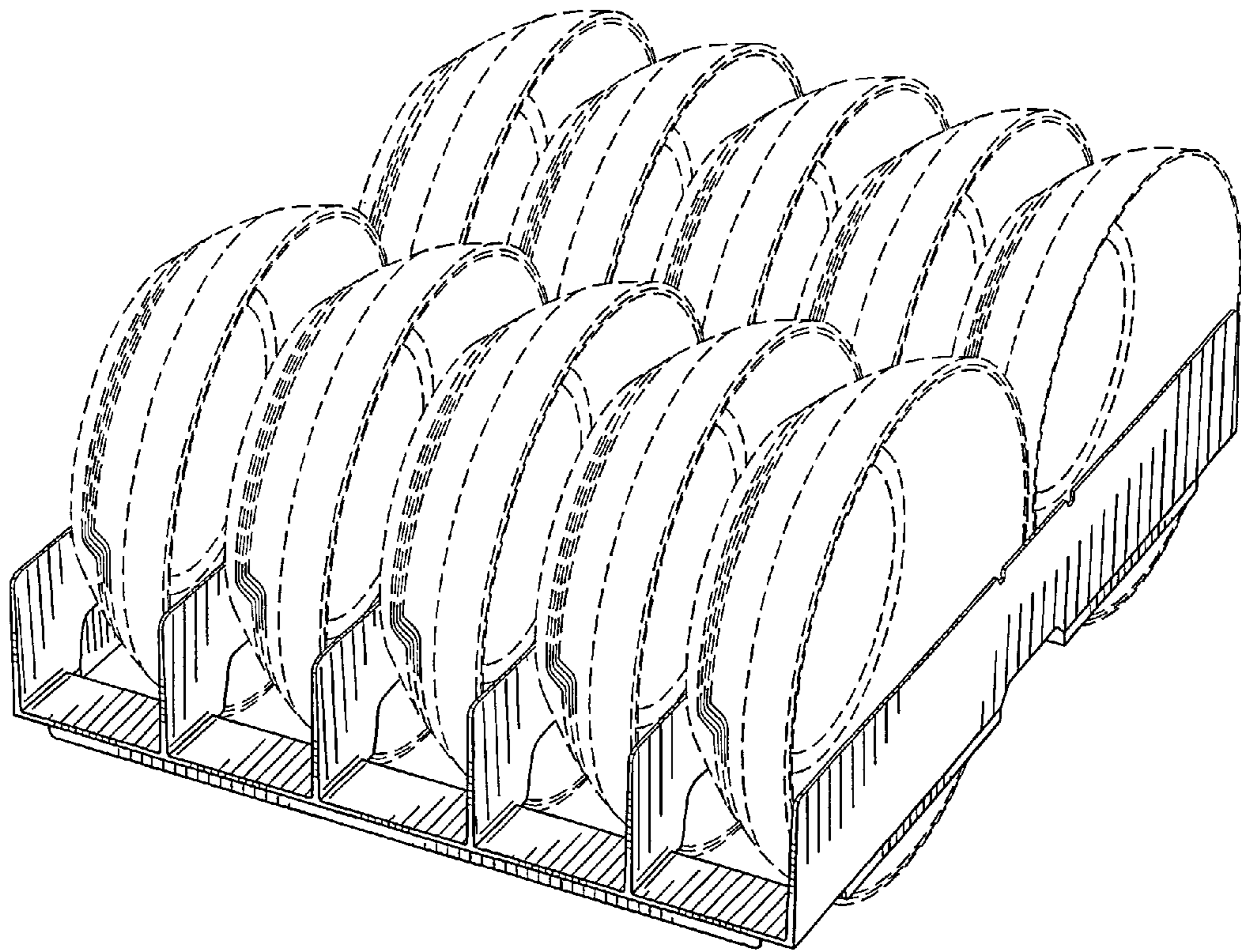

FIG. 8