



US00D736473S

(12) **United States Design Patent**
Samples

(10) **Patent No.:** **US D736,473 S**

(45) **Date of Patent:** **** Aug. 11, 2015**

(54) **SPARRING PROTECTIVE EQUIPMENT**

Primary Examiner — Susan Bennett Hattan

(76) Inventor: **Randolph S. Samples**, Lithonia, GA
(US)

Assistant Examiner — Barbara B Lohr

(74) *Attorney, Agent, or Firm* — George R. Reardon

(**) Term: **14 Years**

(21) Appl. No.: **29/394,359**

(22) Filed: **Jun. 16, 2011**

(51) **LOC (10) Cl.** **29-03**

(52) **U.S. Cl.**
USPC **D29/101.4**

(58) **Field of Classification Search**
USPC D29/100, 101.1–101.4; D10/104.1;
2/44, 102, 161.6, 462, 463–465, 467;
73/12.01–12.14; D2/829
See application file for complete search history.

(57) **CLAIM**

The ornamental design for sparring protective equipment, as shown and described.

DESCRIPTION

FIG. 1 is a front elevational view of sparring protective equipment, showing my new design;
FIG. 2 is a rear elevational view thereof;
FIG. 3 is a right elevational view thereof;
FIG. 4 is a left side elevational view thereof;
FIG. 5 is a top plan view of sparring protective equipment;
and,
FIG. 6 is an elevational view of the glove portion of the sparring protective equipment, illustrating detail of the sewn-together fingers.
The person shown in broken lines in FIGS. 1-6 is for illustrative purposes only and forms no part of the claimed design. The dotted lines on the glove in FIG. 6 illustrate stitching holding the glove fingers together.

(56) **References Cited**

U.S. PATENT DOCUMENTS

D330,271 S	10/1992	Samples	
D486,609 S *	2/2004	Park	D29/100
7,451,497 B2 *	11/2008	von Blucher	2/161.6
D595,603 S *	7/2009	Gordin et al.	D10/104.1
7,739,753 B2 *	6/2010	Jankowski	2/463
D640,009 S *	6/2011	Richardson	D29/101.4
D652,573 S *	1/2012	Rodriguez	D29/101.4

* cited by examiner

1 Claim, 6 Drawing Sheets

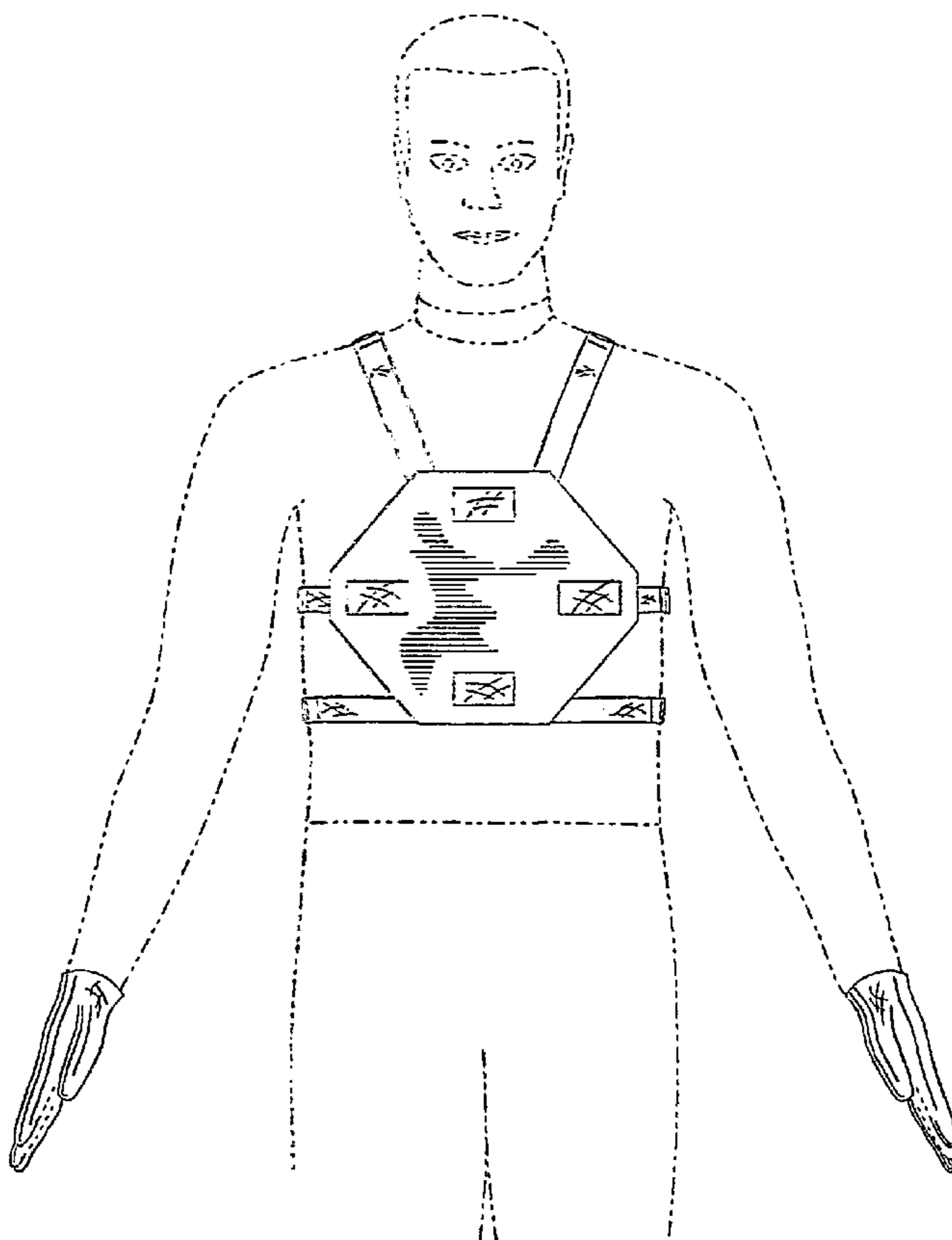

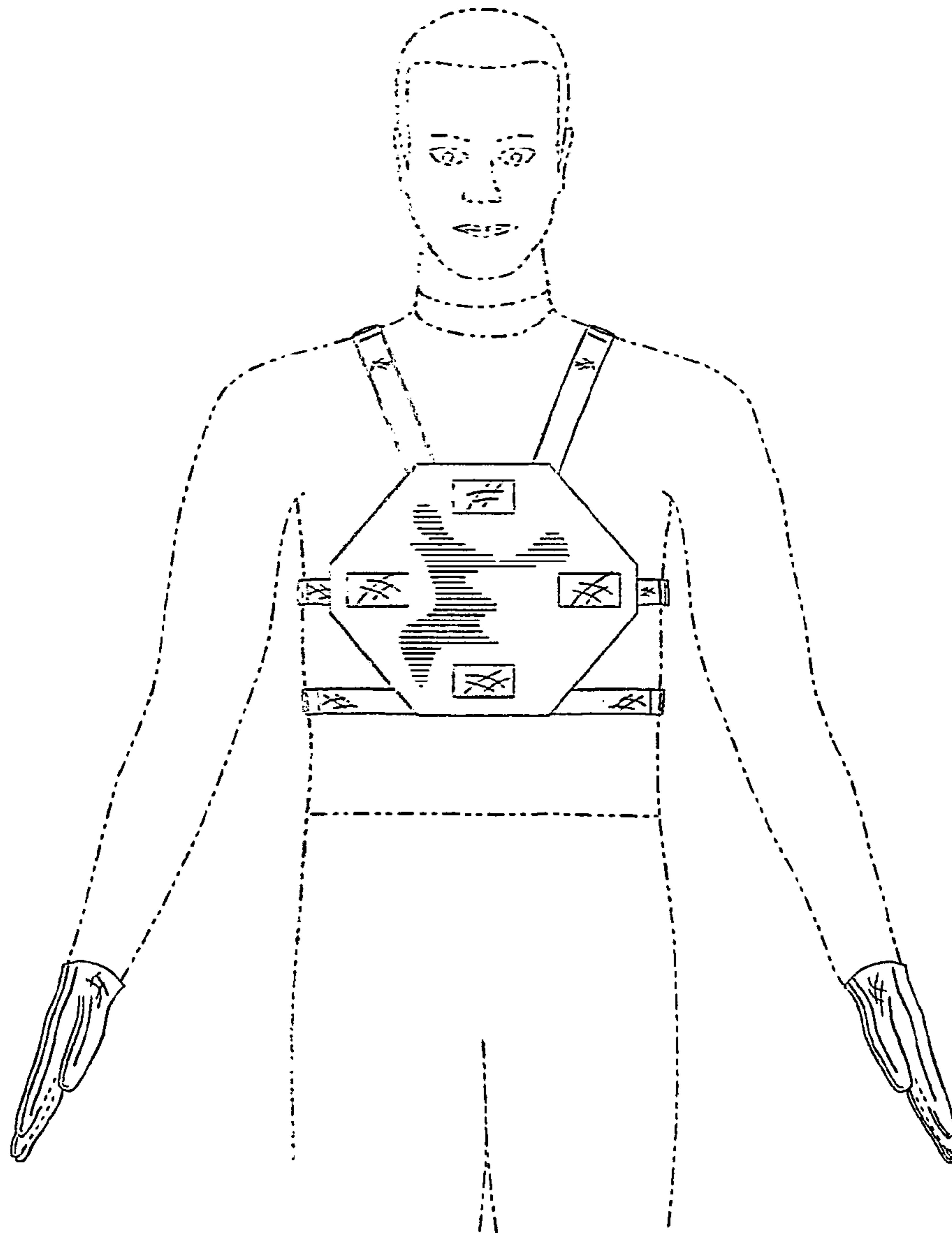

FIG. 1

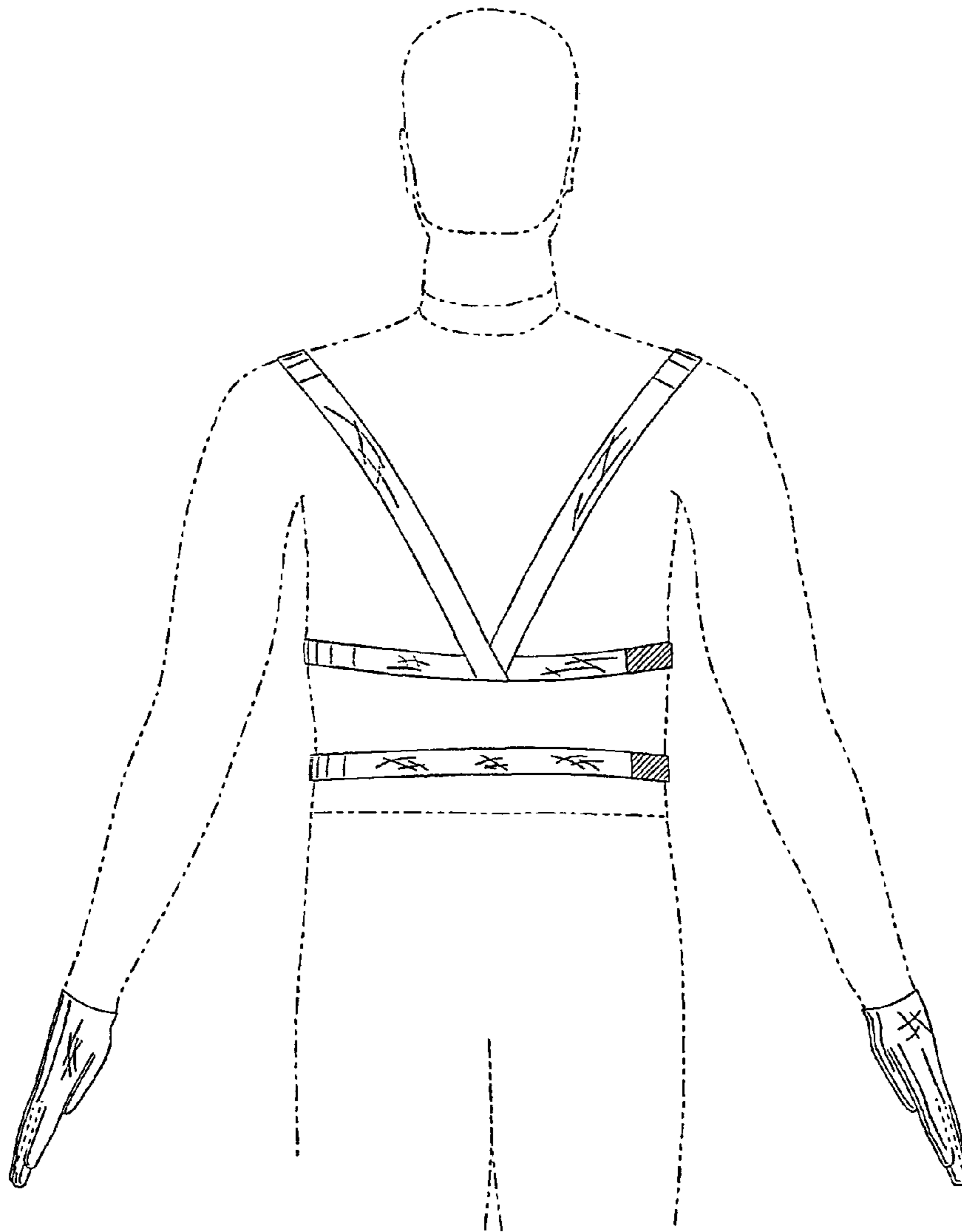

FIG. 2

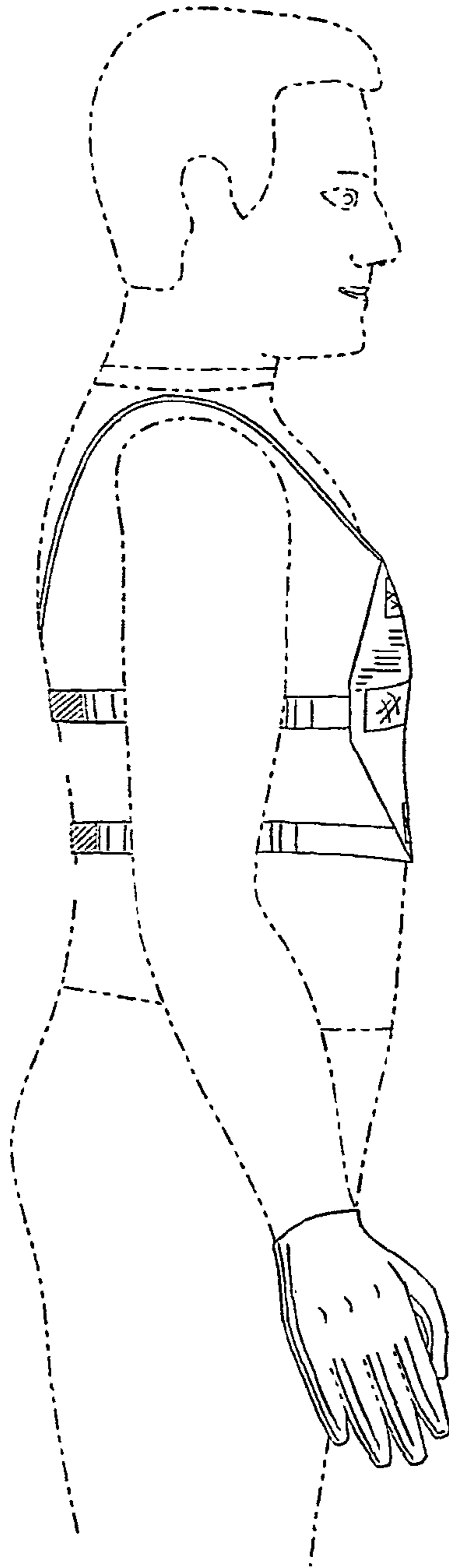

FIG. 3

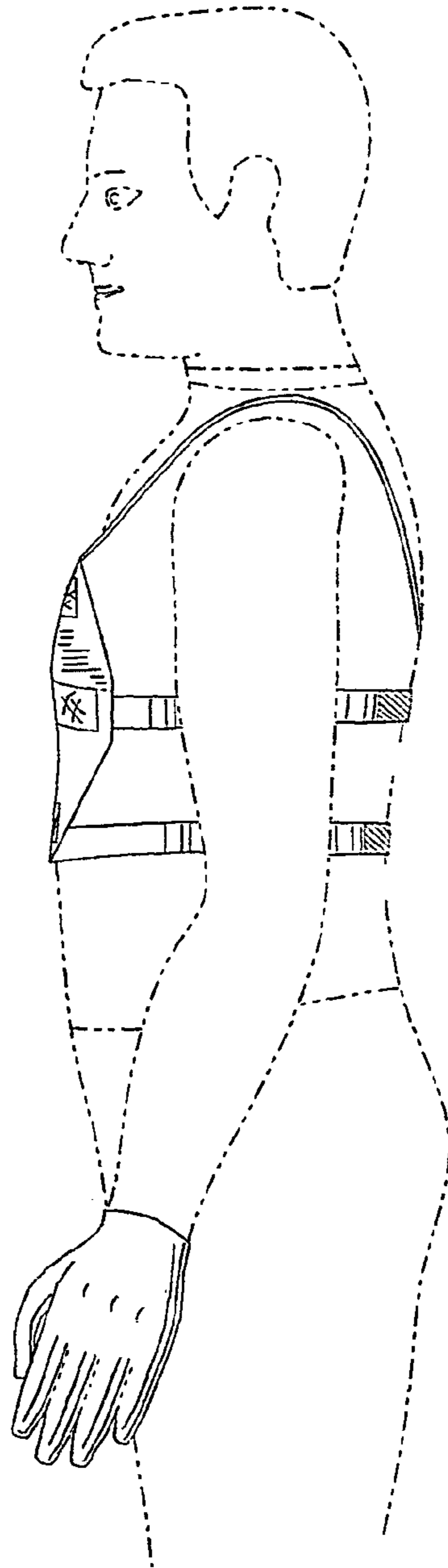

FIG. 4

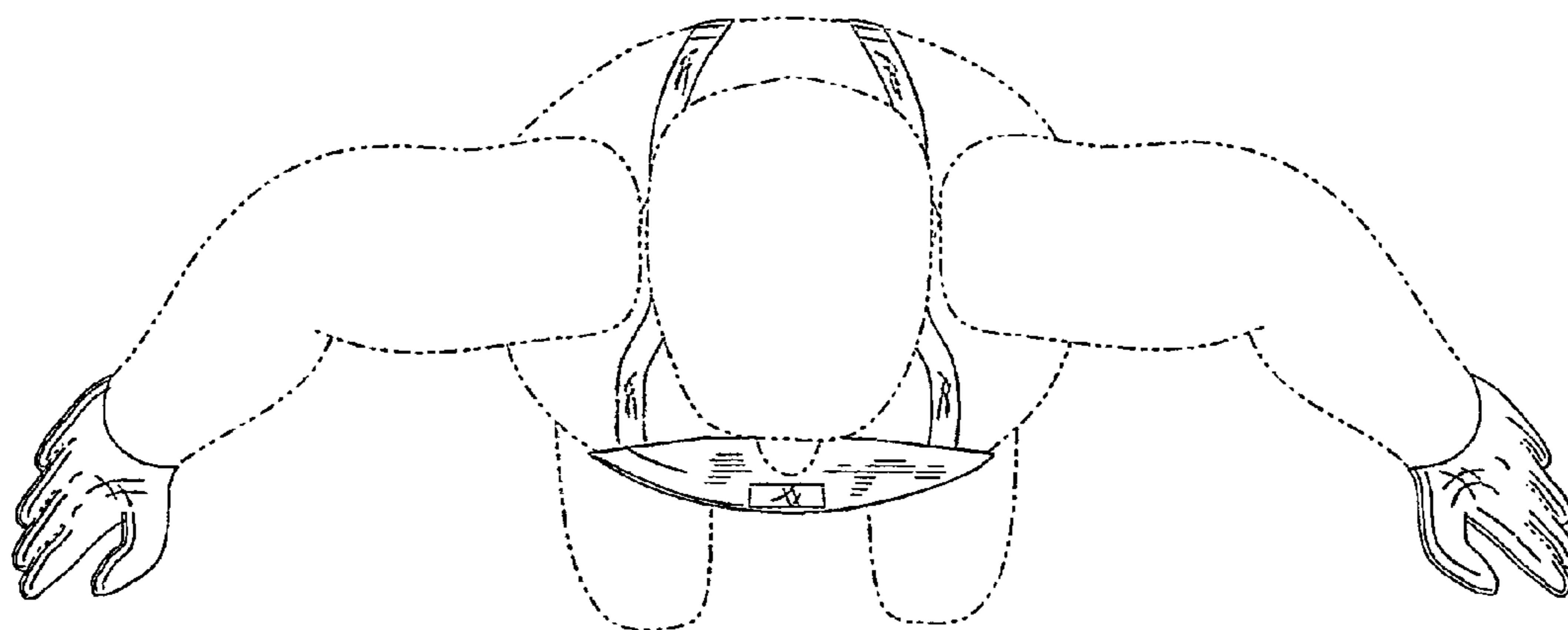

FIG. 5

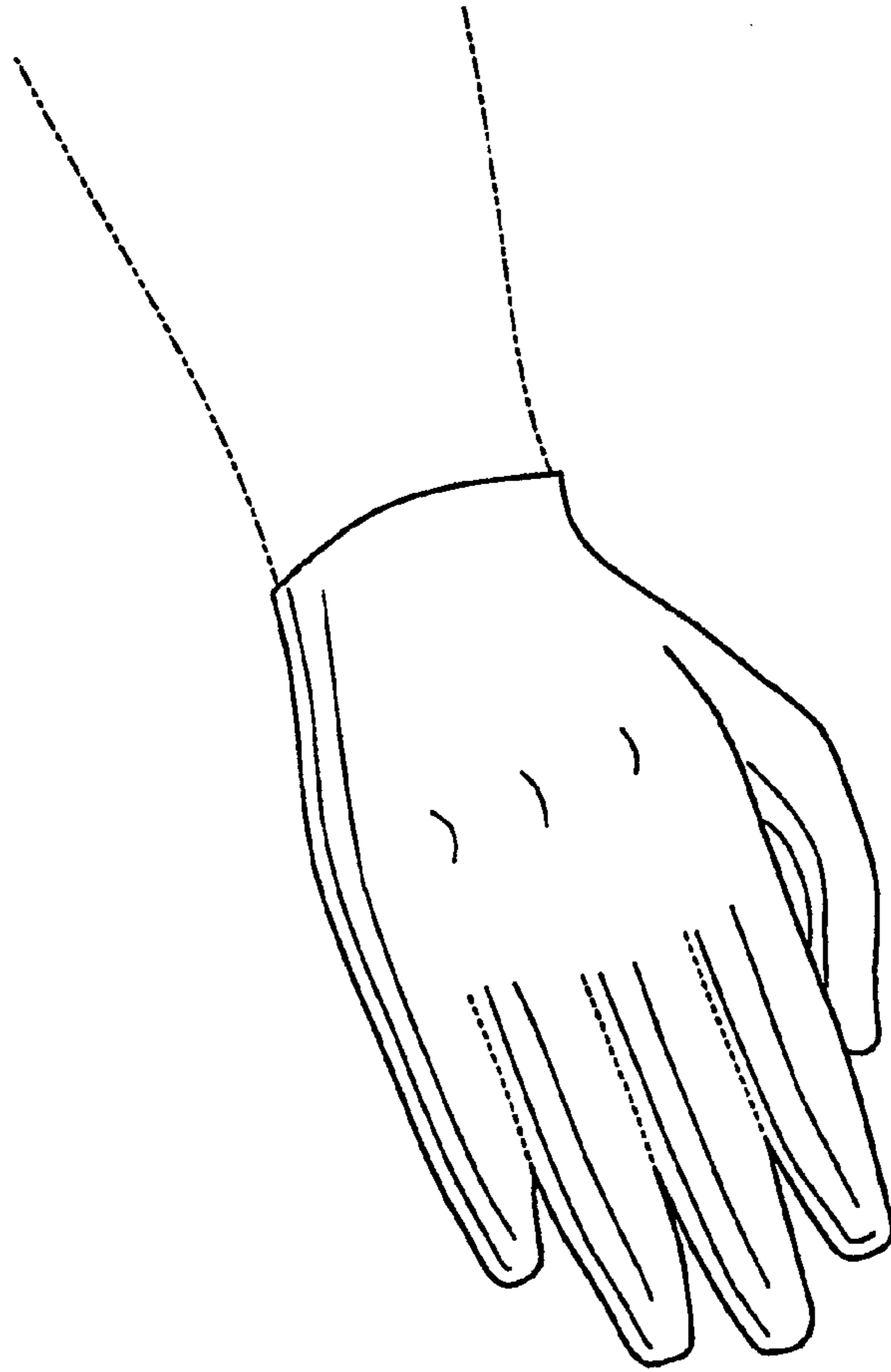

FIG. 6