



US00D736410S

(12) **United States Design Patent**  
**Alsdorf et al.**

(10) **Patent No.:** **US D736,410 S**

(45) **Date of Patent:** **\*\* Aug. 11, 2015**

(54) **DOOR FACING**

(74) *Attorney, Agent, or Firm* — Berenato & White, LLC

(71) Applicant: **Masonite Corporation**, Tampa, FL (US)

(57) **CLAIM**

The ornamental design for a door facing, as shown and described.

(72) Inventors: **Shaun Alsdorf**, Tampa, FL (US);  
**Timothy D. Gouge**, Elgin, IL (US);  
**Robert C. Allen**, Elburn, IL (US)

**DESCRIPTION**

(73) Assignee: **Masonite Corporation**, Tampa, FL (US)

(\*\*) Term: **14 Years**

(21) Appl. No.: **29/479,197**

(22) Filed: **Jan. 13, 2014**

(51) **LOC (10) Cl.** ..... **25-02**

(52) **U.S. Cl.**  
USPC ..... **D25/48.3**

(58) **Field of Classification Search**

USPC ..... D25/300, 48.3, 60; D6/703, 703.2,  
D6/705.5, 657, 671, 702; 52/455, 309.9,  
52/313; 256/73; 428/106  
CPC ..... E06B 3/7001; E06B 2003/7019; E06B  
3/7017; E06B 3/74; E06B 2003/7049; E06B  
3/78; E06B 2003/7096; E06B 3/72; E06B  
3/76; E06B 3/822; E06B 2003/7023; E06B  
2003/7051; E06B 5/12; Y10T 156/1002;  
Y10T 428/24066

See application file for complete search history.

(56) **References Cited**

**U.S. PATENT DOCUMENTS**

1,018,896 A \* 2/1912 Frey ..... 52/455  
5,016,414 A 5/1991 Wang  
5,293,726 A 3/1994 Schick  
D467,350 S 12/2002 Jimenez et al.  
D510,771 S \* 10/2005 Walsh et al. .... D25/48.3  
D516,226 S 2/2006 Lynch et al.  
7,022,414 B2 4/2006 Davina et al.  
D526,418 S \* 8/2006 Walsh et al. .... D25/48.3

(Continued)

*Primary Examiner* — Philip S Hyder

*Assistant Examiner* — Keith Frank

FIG. 1 is a front perspective view of our design;  
FIG. 2 is a front elevational view;  
FIG. 3 is a rear elevational view;  
FIG. 4 is a top plan view;  
FIG. 5 is a bottom plan view;  
FIG. 6 is a cross sectional view taken along the line 6-6 of FIG. 2;  
FIG. 7 is a cross-sectional view taken along the line 7-7 of FIG. 2;  
FIG. 8 is an enlarged fragmentary cross-sectional view of a portion of FIG. 7;  
FIG. 9 is a right side elevational view;  
FIG. 10 is a left side elevational view;  
FIG. 11 is a cross sectional view taken along the line 11-11 of FIG. 2;  
FIG. 12 is a front perspective view of a second version of our design;  
FIG. 13 is a front elevational view;  
FIG. 14 is a rear elevational view;  
FIG. 15 is a top plan view;  
FIG. 16 is a bottom plan view;  
FIG. 17 is a cross sectional view taken along the line 17-17 of FIG. 13;  
FIG. 18 is a cross sectional view taken along the line 18-18 of FIG. 13;  
FIG. 19 is an enlarged fragmentary cross sectional view of a portion of FIG. 18;  
FIG. 20 is a right side elevational view;  
FIG. 21 is a left side elevational view; and,  
FIG. 22 is a cross sectional view taken along the line 22-22 of FIG. 13.

The profiles of FIGS. 8 and 19 extend continuously about all panels of the associated door facings.

**1 Claim, 10 Drawing Sheets**

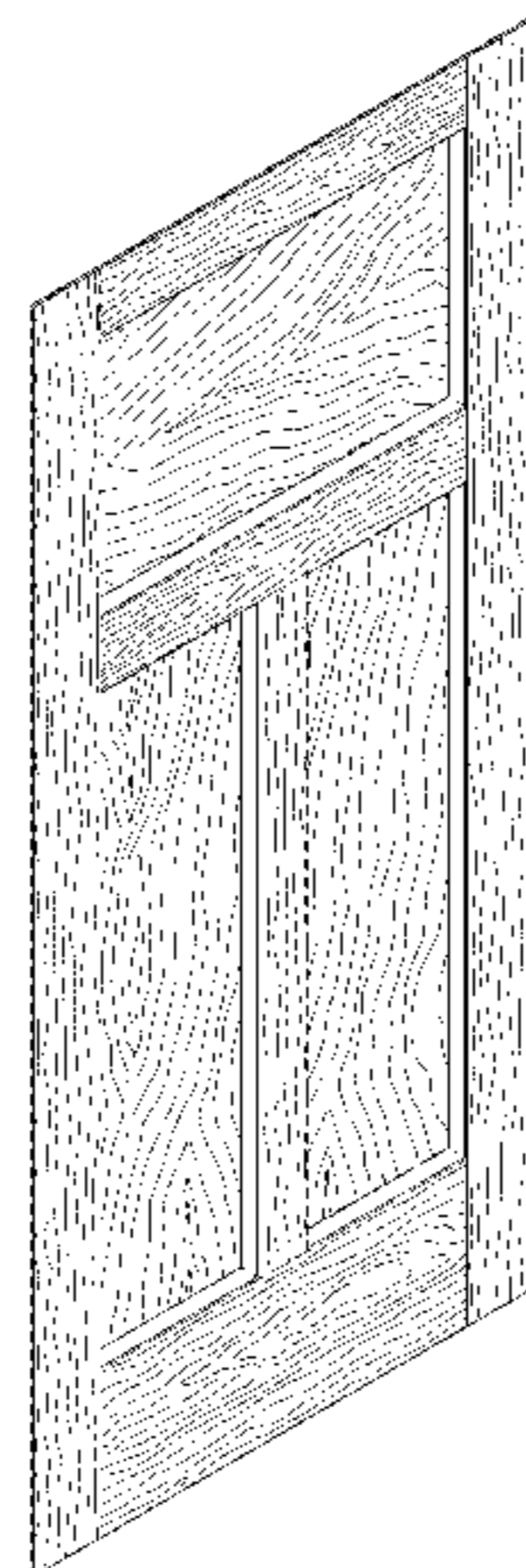
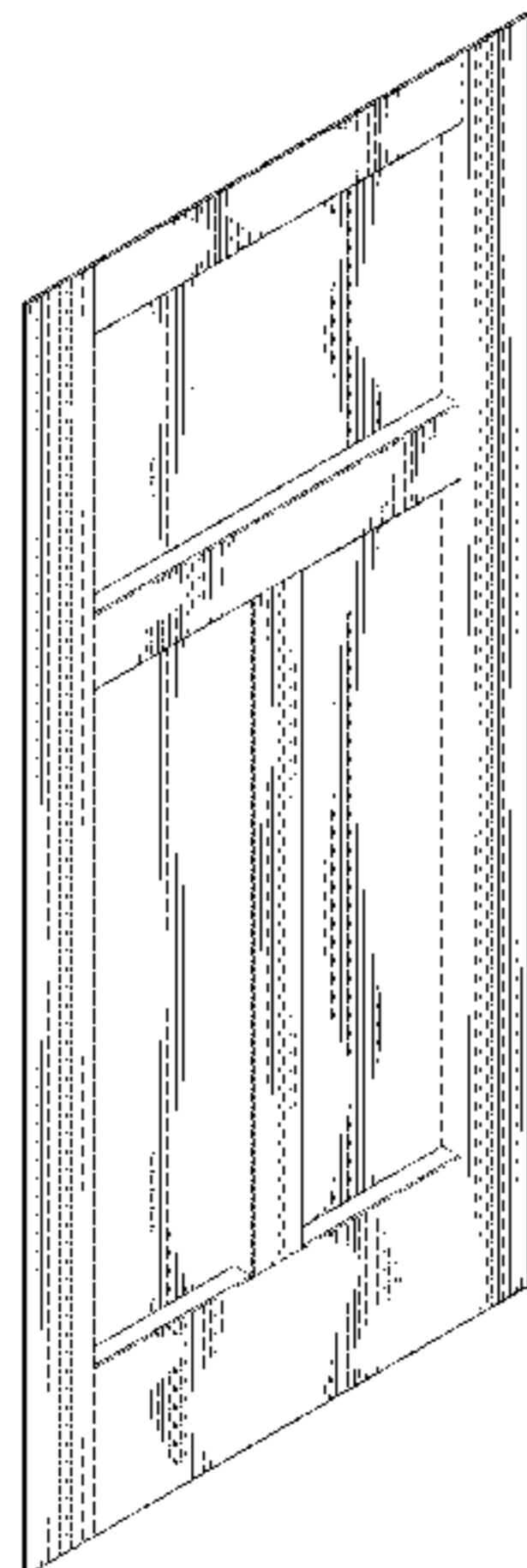

(56)

**References Cited**

U.S. PATENT DOCUMENTS

D528,664 S	9/2006	Lynch et al.	
D528,665 S	9/2006	Lynch et al.	
D529,189 S	9/2006	Walsh et al.	
D536,099 S	1/2007	Walsh et al.	
D538,440 S *	3/2007	Walsh et al.	..... D25/48.3
D543,641 S *	5/2007	Walsh et al.	..... D25/48.3
D552,252 S	10/2007	Davina et al.	
D553,755 S	10/2007	Davina et al.	
D576,289 S *	9/2008	Steiber et al.	..... D25/48.3
D587,813 S *	3/2009	Steiber et al.	..... D25/48.3
D588,710 S	3/2009	Walsh et al.	
D598,134 S	8/2009	Davina et al.	
D607,120 S	12/2009	Davina et al.	
D607,121 S	12/2009	Davina et al.	
D614,310 S	4/2010	Davina et al.	
D616,109 S	5/2010	Steiber et al.	
D683,865 S *	6/2013	Walsh et al.	..... D25/48.3
D687,164 S *	7/2013	Walsh et al.	..... D25/48.3
D695,912 S *	12/2013	Walsh et al.	..... D25/48.3
D698,040 S *	1/2014	Walsh et al.	..... D25/48.3
2010/0229500 A1 *	9/2010	Lynch et al.	..... 52/784.13

\* cited by examiner

Fig. 1

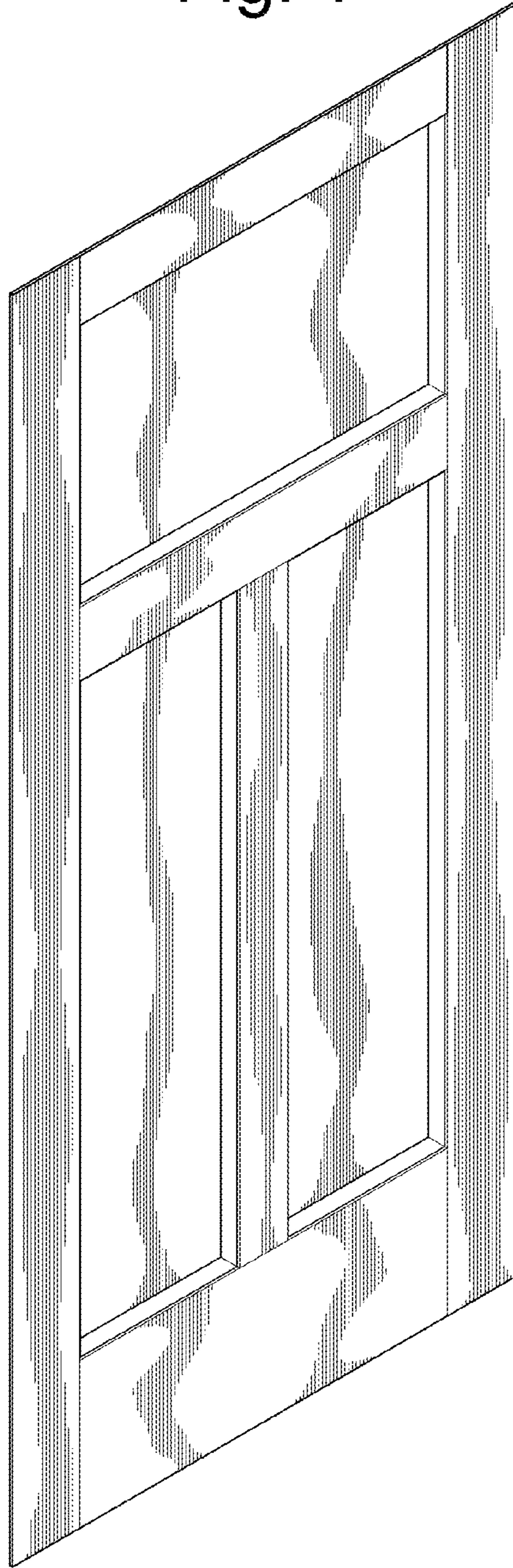

Fig. 2

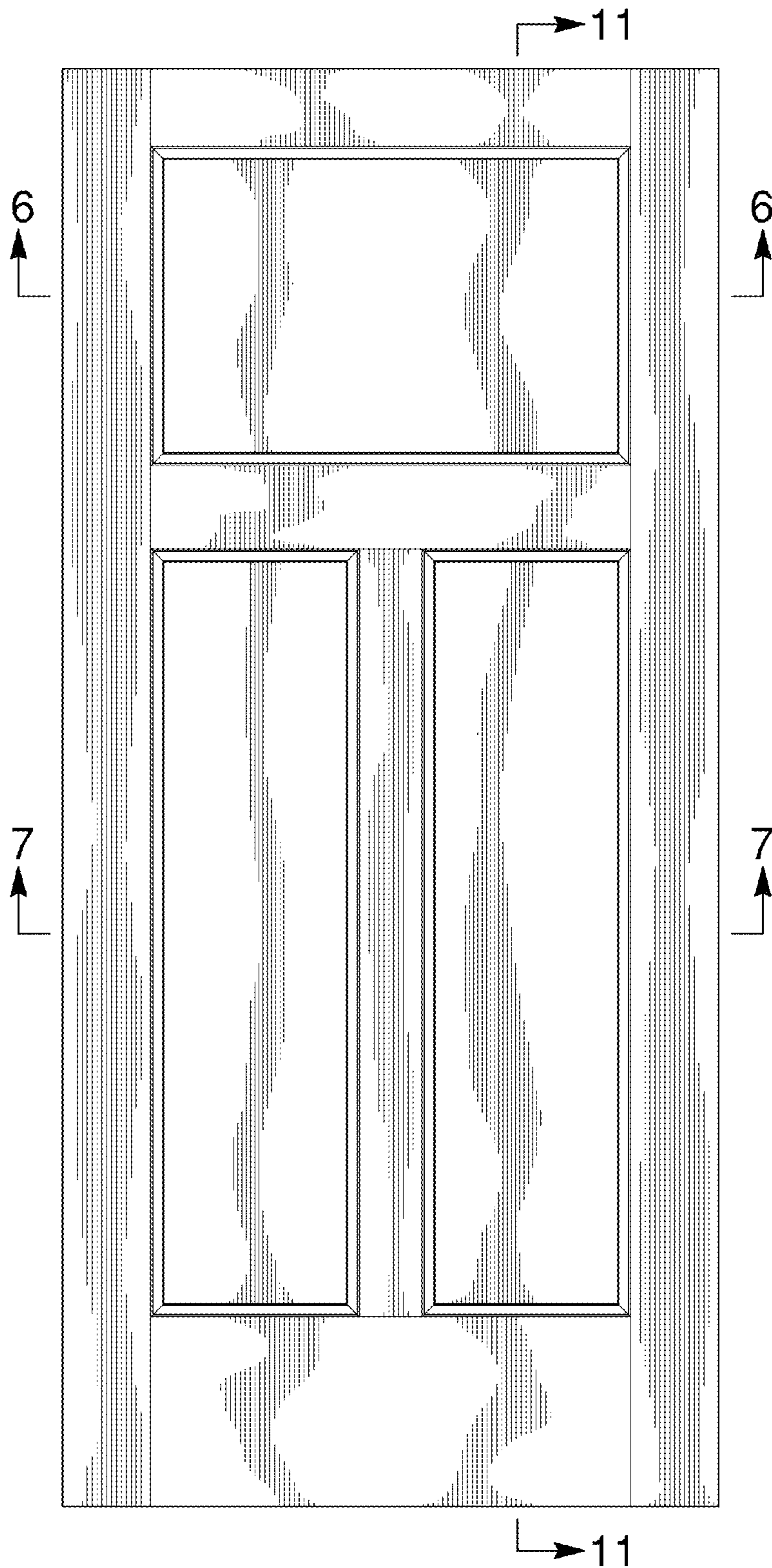

Fig. 3

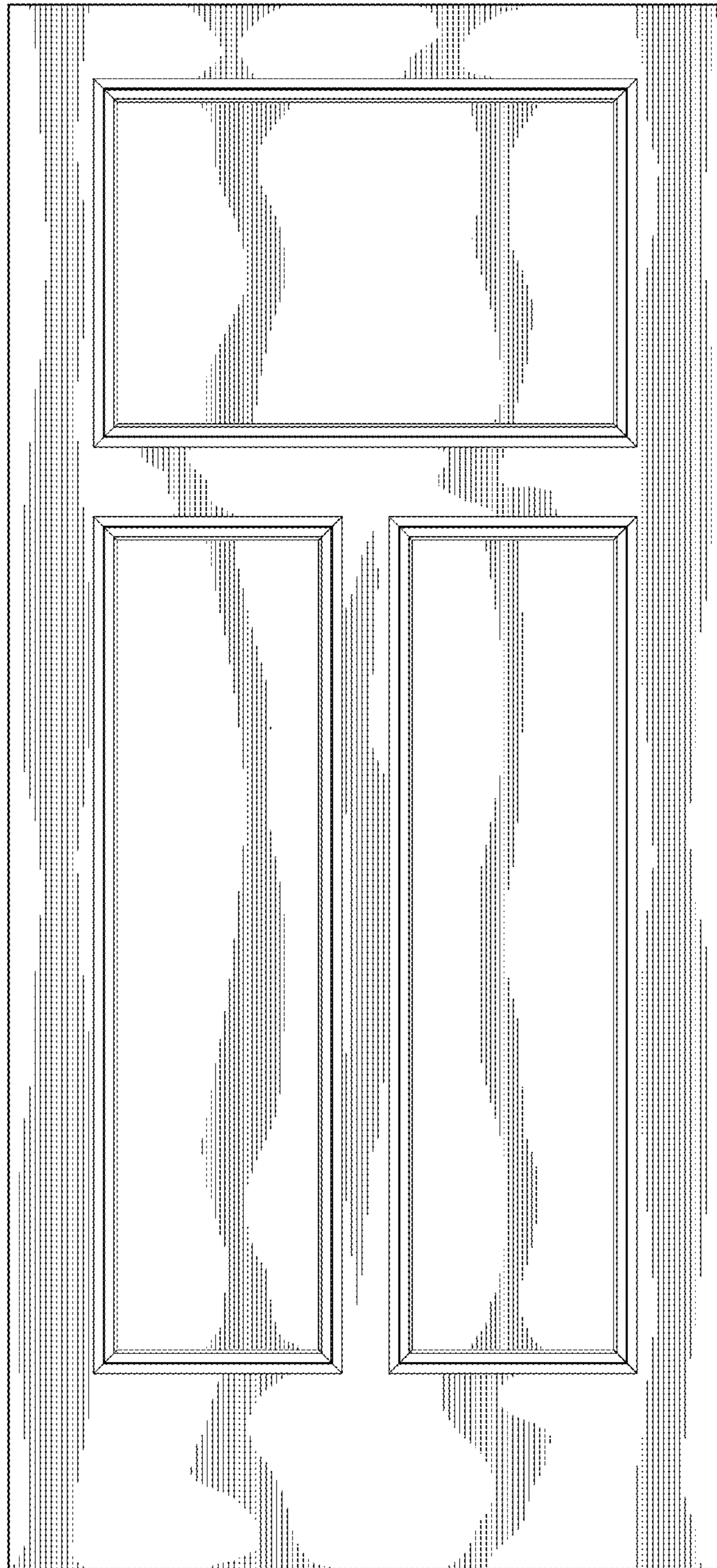

Fig. 4

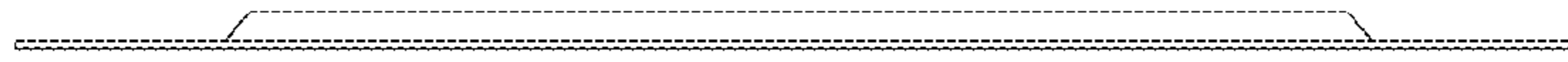

Fig. 5

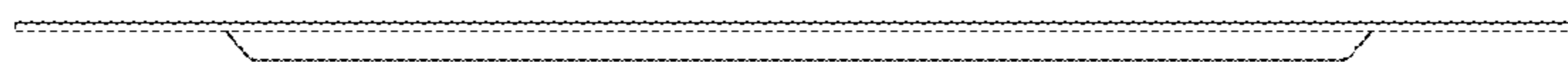

Fig. 6

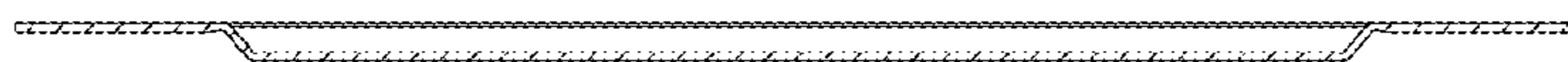

Fig. 7

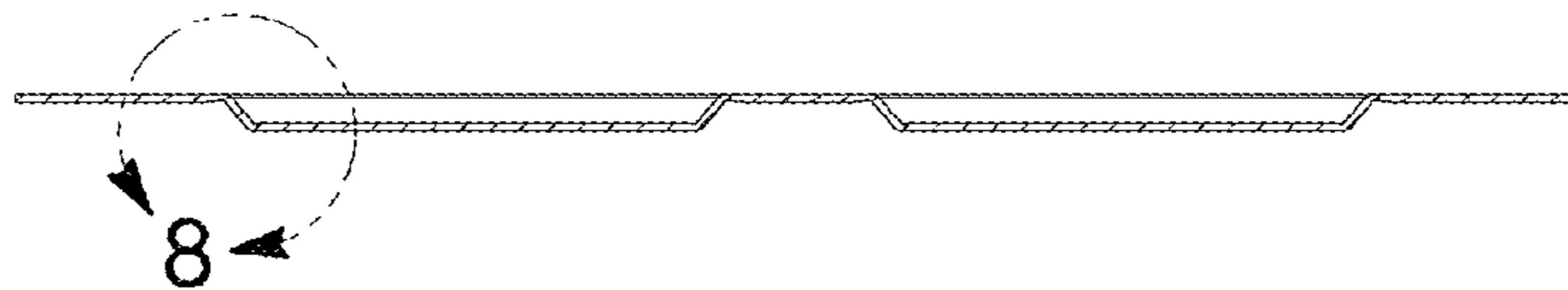

Fig. 8

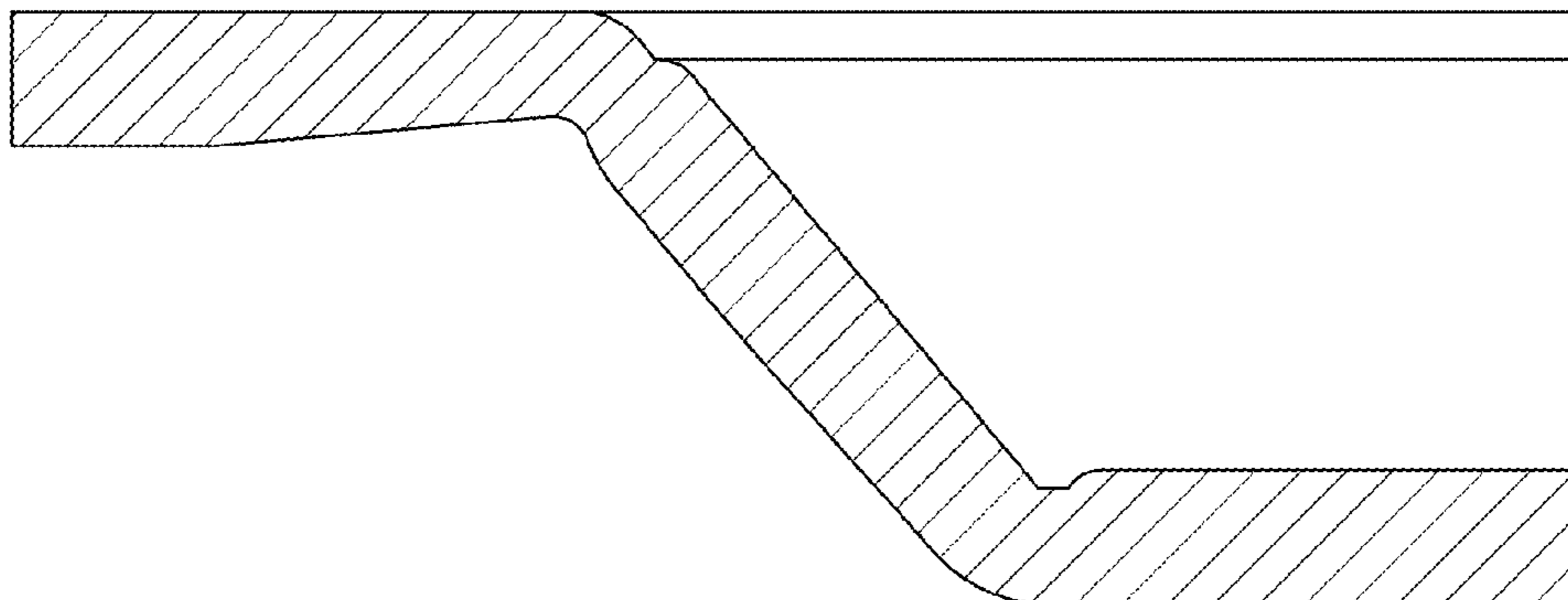

Fig. 9

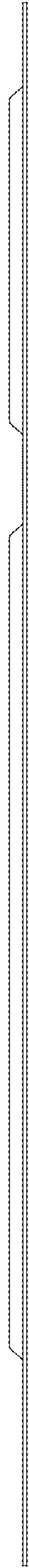

Fig. 10

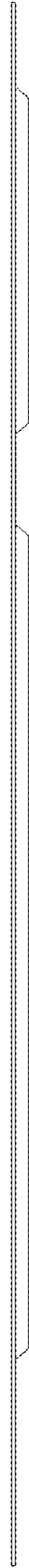

Fig. 11

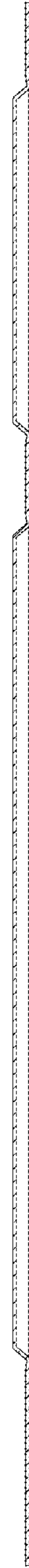

Fig. 12

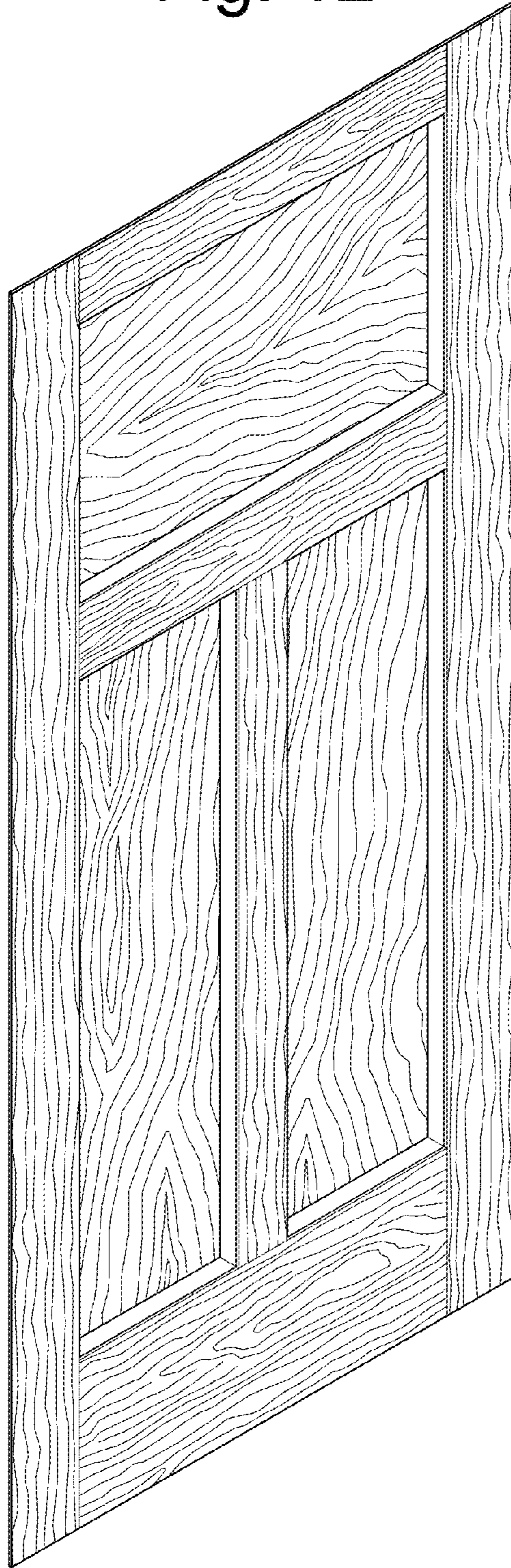



Fig. 13

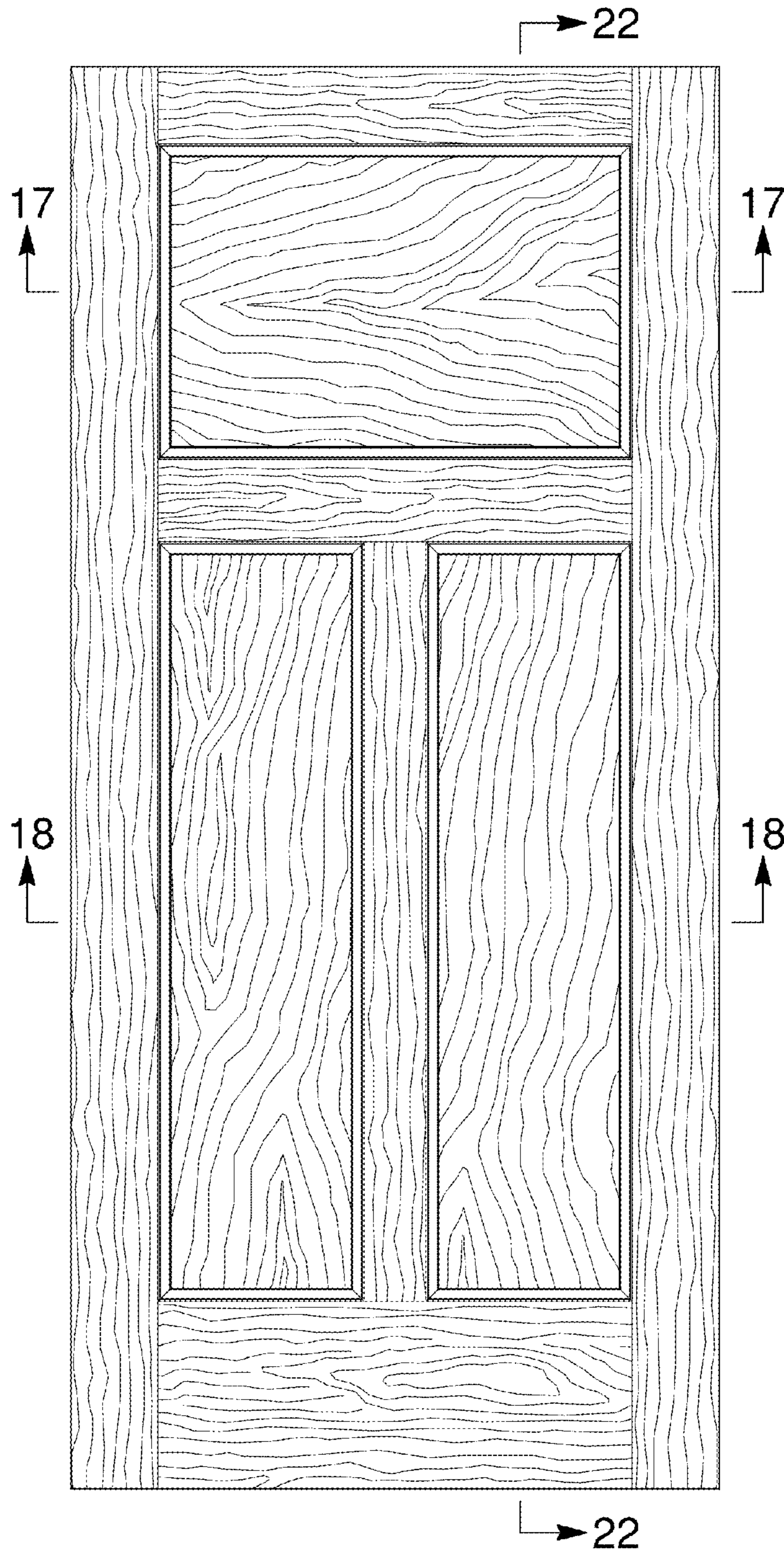

Fig. 14

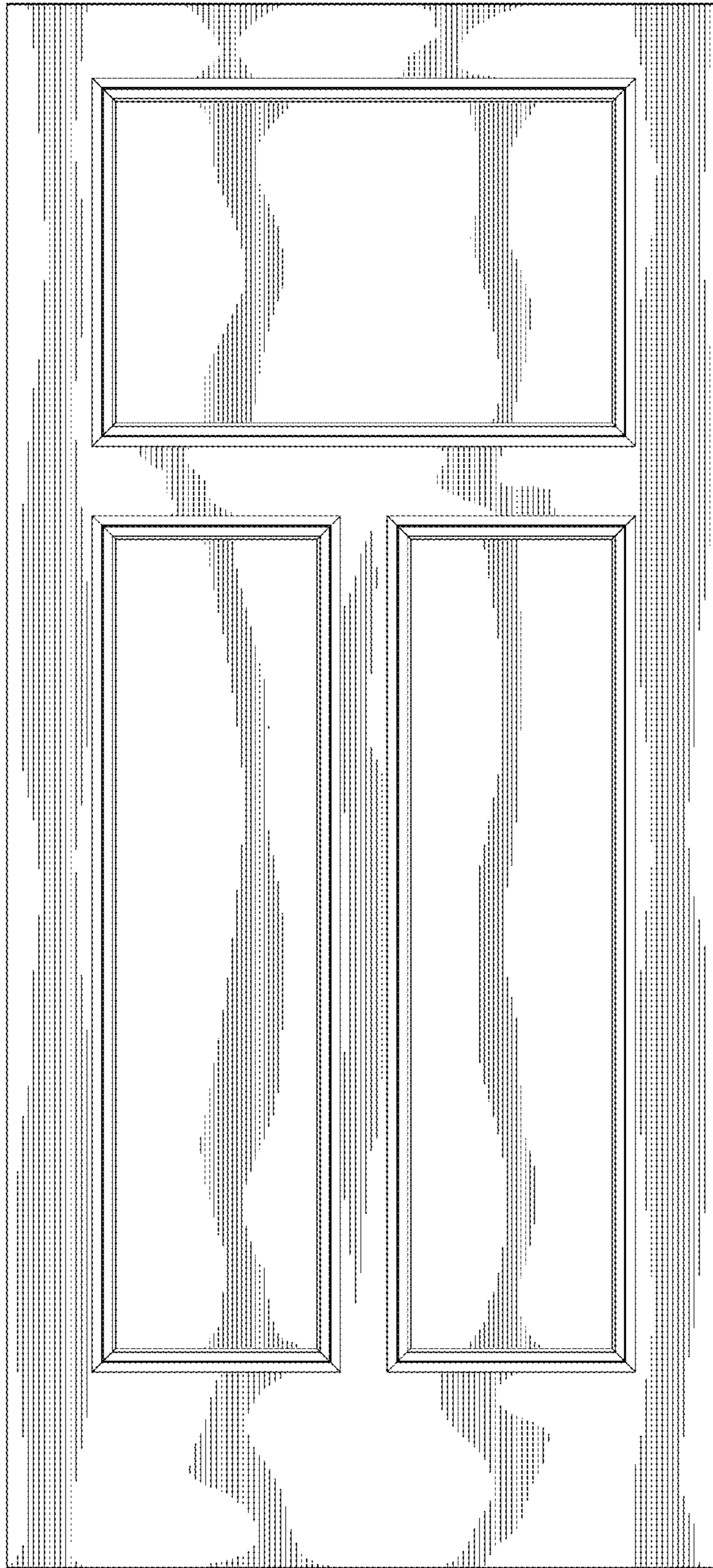

Fig. 15

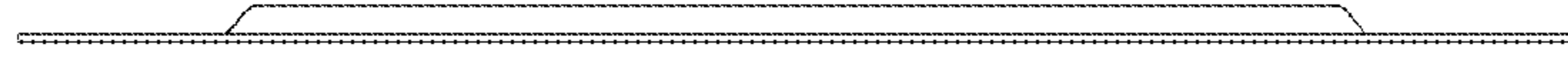

Fig. 16

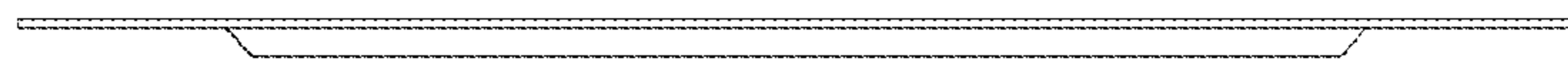

Fig. 17

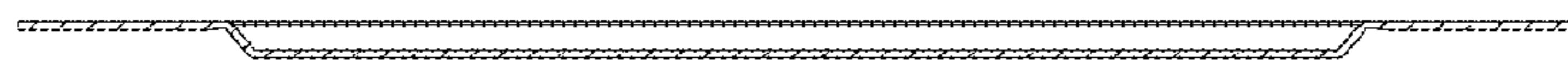

Fig. 18

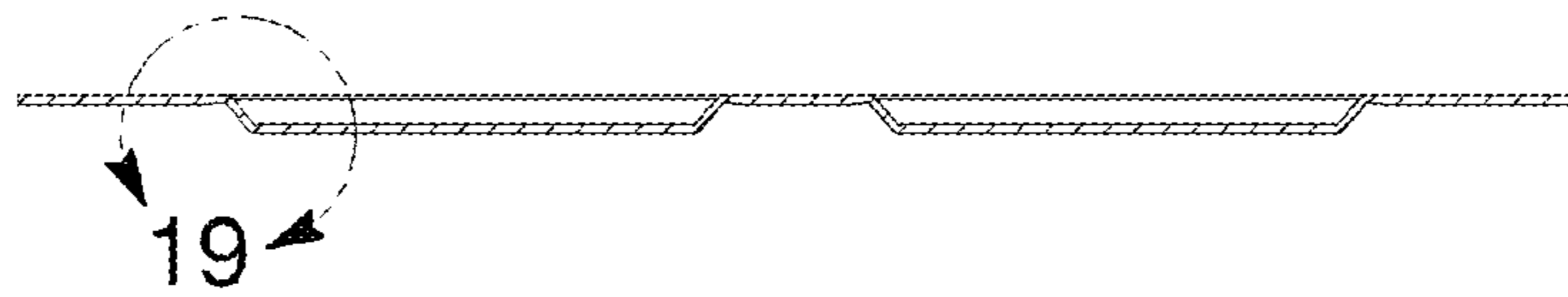

Fig. 19

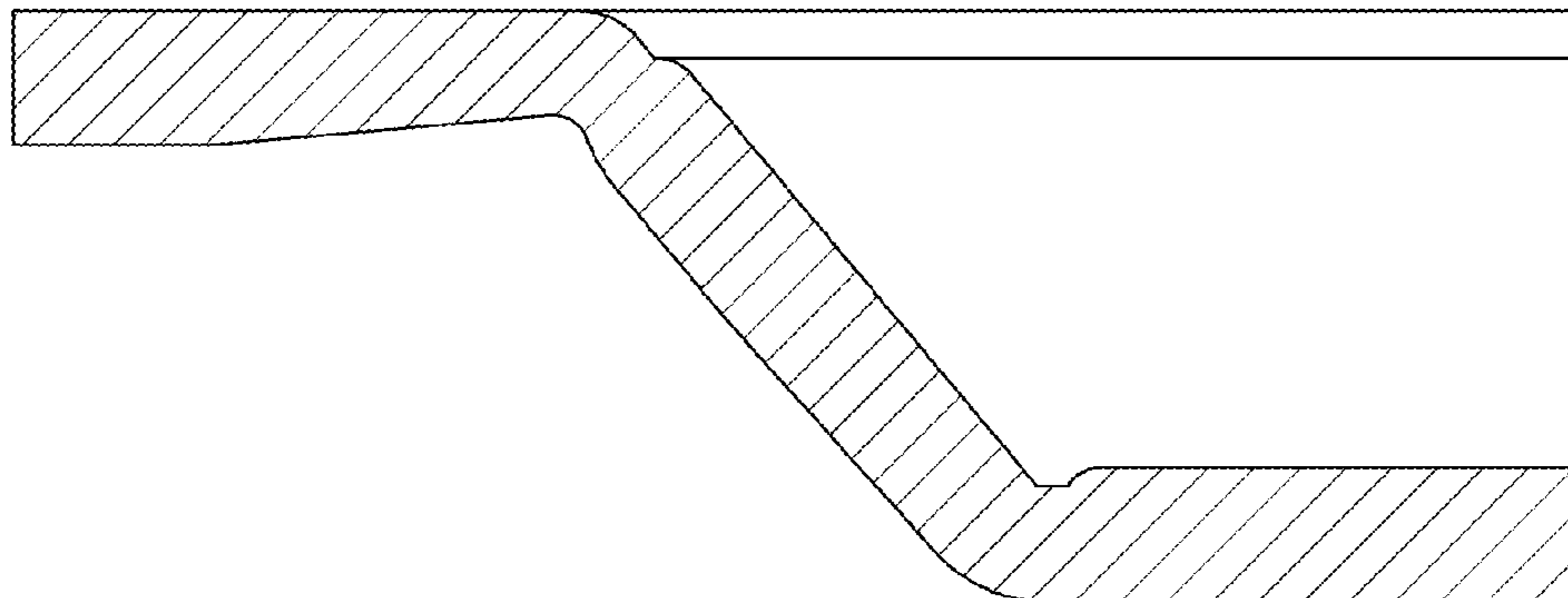

Fig. 20

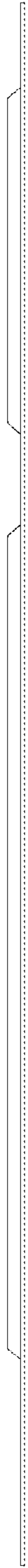

Fig. 21

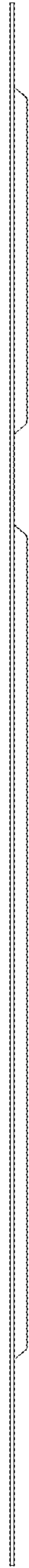

Fig. 22

