

US00D736272S

(12) **United States Design Patent**
Stolarz et al.

(10) **Patent No.:** **US D736,272 S**
(45) **Date of Patent:** **** Aug. 11, 2015**

(54) **COOLER**

(71) Applicant: **PepsiCo, Inc.**, Purchase, NY (US)

(72) Inventors: **Christian Stolarz**, Brooklyn, NY (US);
Martin Eduardo Broen, New York, NY (US)

(73) Assignee: **PepsiCo, Inc.**, Purchase, NY (US)

(**) Term: **14 Years**

(21) Appl. No.: **29/481,899**

(22) Filed: **Feb. 11, 2014**

(51) **LOC (10) Cl.** **15-07**

(52) **U.S. Cl.**
USPC **D15/81**

(58) **Field of Classification Search**

USPC D15/79, 80, 81, 87, 88
CPC F25C 1/00; F25C 5/005; F25C 1/04;
F25C 1/22; F25C 5/182; F25C 1/24; F25C
2305/022; F25C 5/04; F25C 5/06; F25C 1/10;
F25C 1/18; F25C 5/185; F25C 1/12; F25C
1/225; F25C 2400/04; F25C 2400/12; F25C
2400/14; F25D 23/006; F25D 23/04; F25D
2323/00274; F25D 2323/121; F25D 2400/16;
F25D 2400/361; F25D 2400/40; F25D
2500/02; F25D 31/002; F25D 31/007; F25D
2317/0417; F25D 2317/0683; F25D 25/00;
F25D 29/00; F25D 11/003

See application file for complete search history.

(56) **References Cited**

U.S. PATENT DOCUMENTS

D244,019 S * 4/1977 Brown D15/88
D271,107 S 10/1983 Trulaske
D363,398 S 10/1995 Branz et al.
5,803,560 A 9/1998 Trulaske, Sr. et al.
D421,534 S 3/2000 Trulaske, Sr. et al.
D449,844 S 10/2001 Kim

D481,224 S 10/2003 Draper
D481,740 S 11/2003 Li et al.
D513,014 S 12/2005 Seki
D518,836 S 4/2006 Reese et al.
D519,528 S * 4/2006 Reese D15/89
D520,532 S 5/2006 Reese et al.
D520,533 S 5/2006 Reese et al.
D541,315 S 4/2007 Trulaske, Sr.
D671,574 S * 11/2012 Jafa et al. D15/91
D671,576 S * 11/2012 Jafa et al. D15/91
2010/0018233 A1 1/2010 Jafa et al.
2011/0301749 A1 12/2011 Hammonds et al.

FOREIGN PATENT DOCUMENTS

EM 002003491-0002 8/2012
EM 001338743-0004 11/2012
JP 1413655 5/2011
TR 2013 05287 10/2013

* cited by examiner

Primary Examiner — Daniel Bui

Assistant Examiner — Khawaja Anwar

(74) *Attorney, Agent, or Firm* — Banner & Witcoff, Ltd.

(57) **CLAIM**

The ornamental design for a cooler, as shown and described.

DESCRIPTION

FIG. 1 is a top, front, right perspective view of a cooler showing our new design;
FIG. 2 is a front view thereof;
FIG. 3 is a right side view thereof;
FIG. 4 is a rear view thereof;
FIG. 5 is a left side view thereof;
FIG. 6 is a top view thereof; and,
FIG. 7 is a bottom view thereof.

The broken lines immediately adjacent to the shaded area represent unclaimed boundaries of the design. The broken lines showing the remainder of the cooler are for environmental purposes only and form no part of the claimed design.

1 Claim, 7 Drawing Sheets

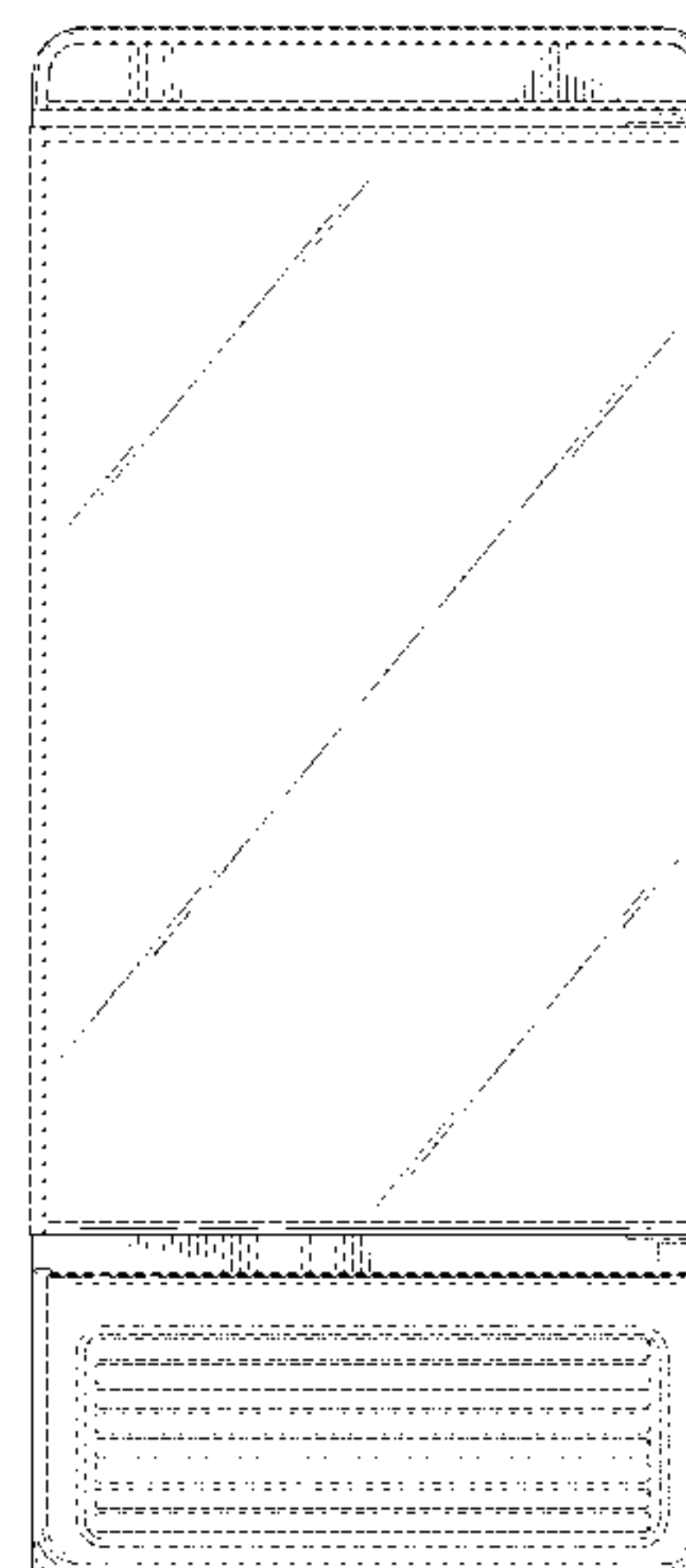
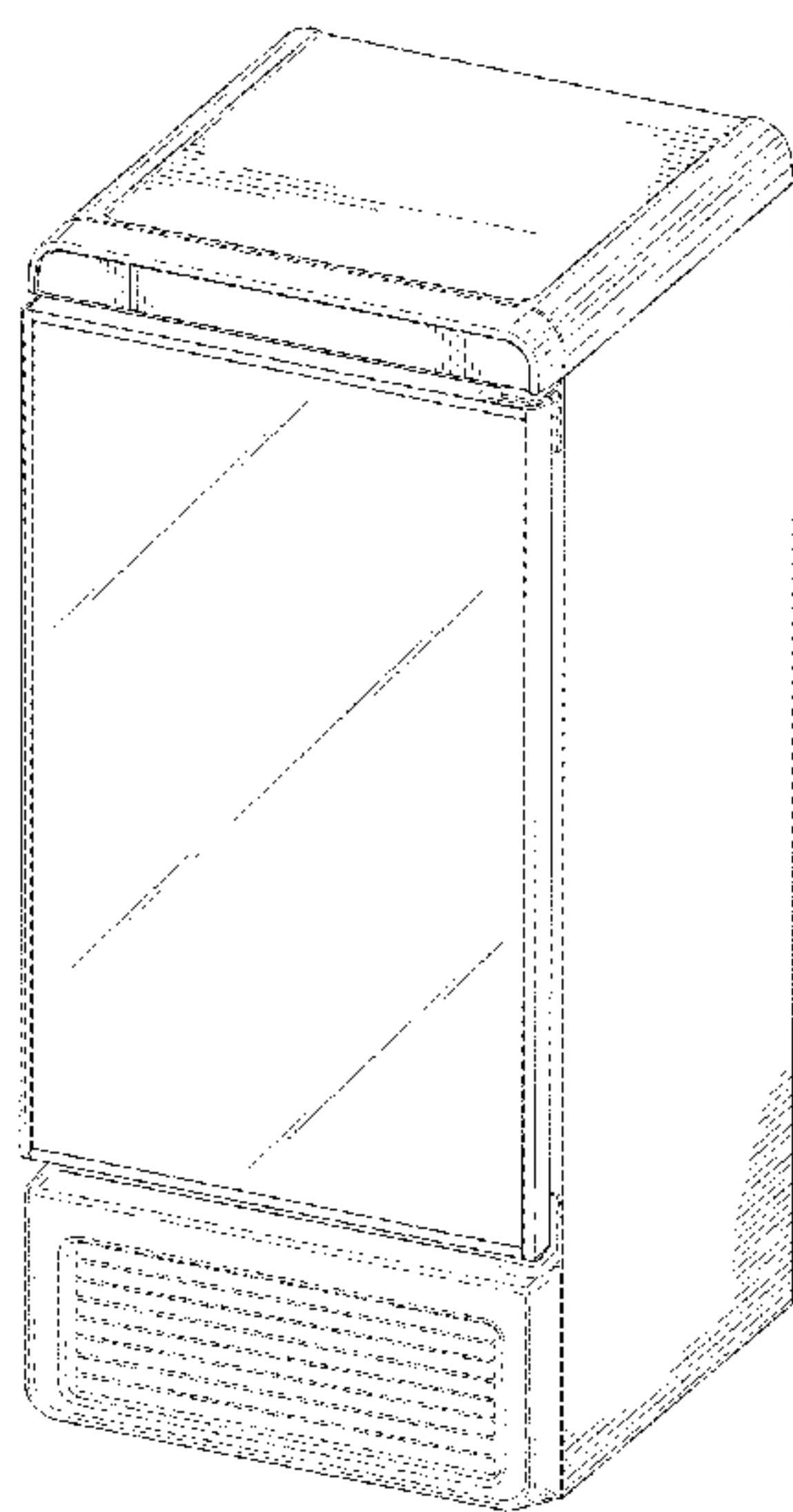

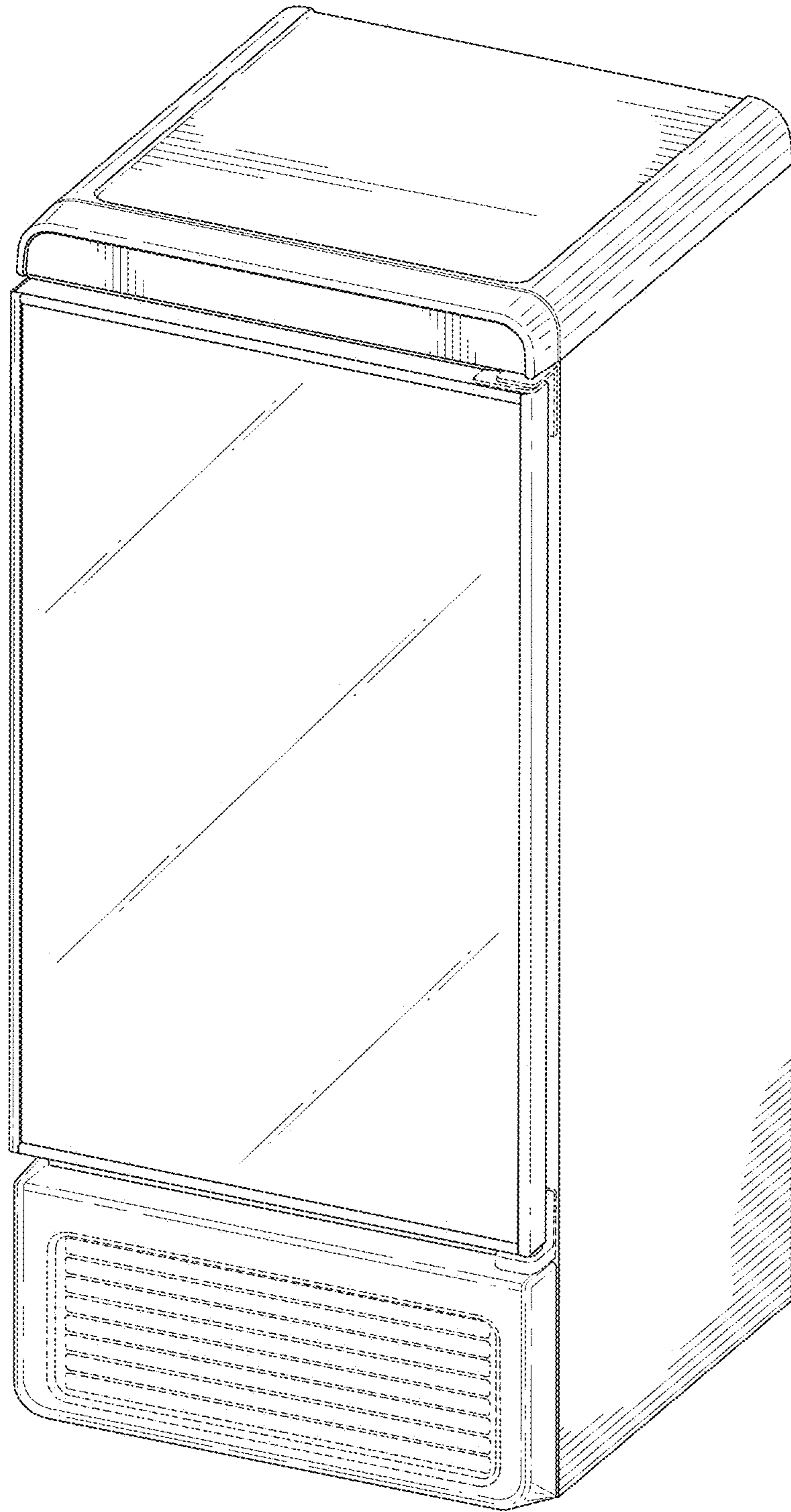

FIG. 1

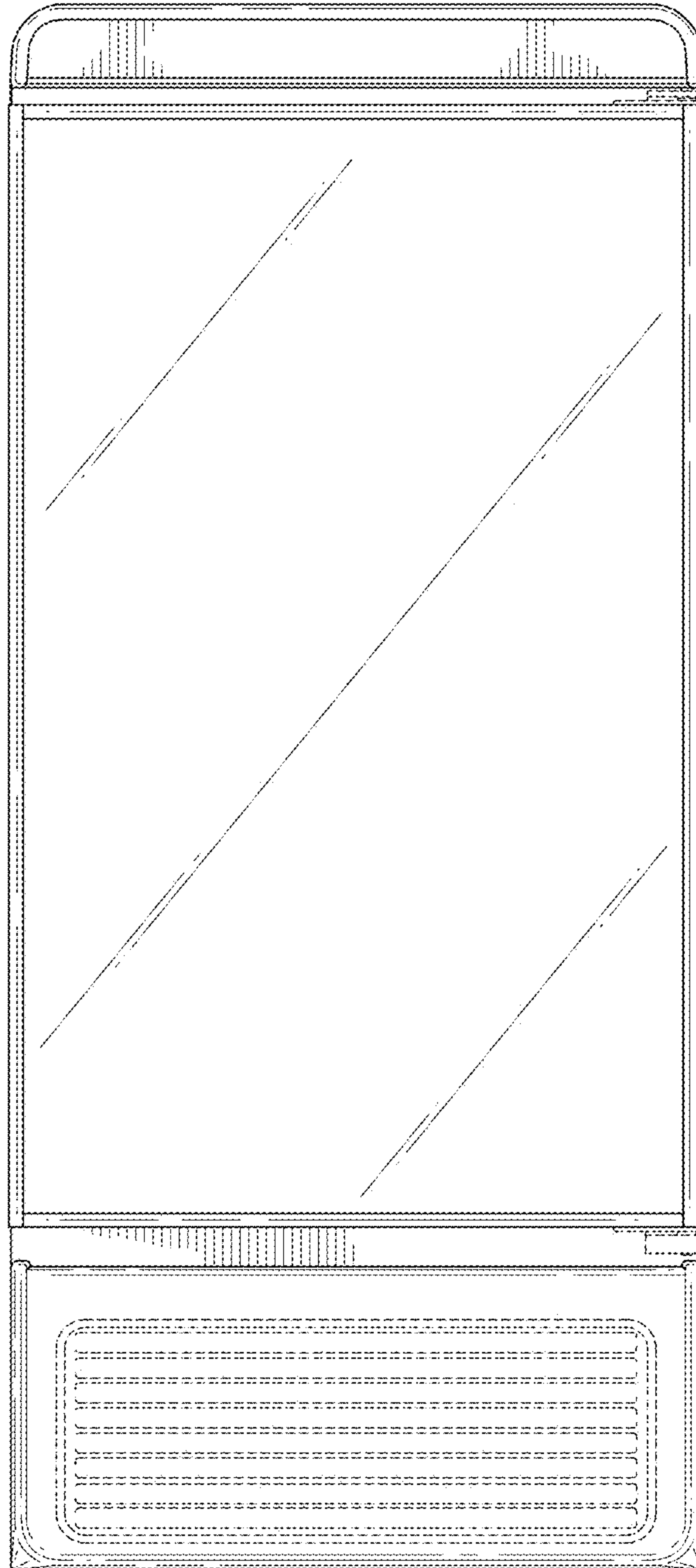

FIG. 2

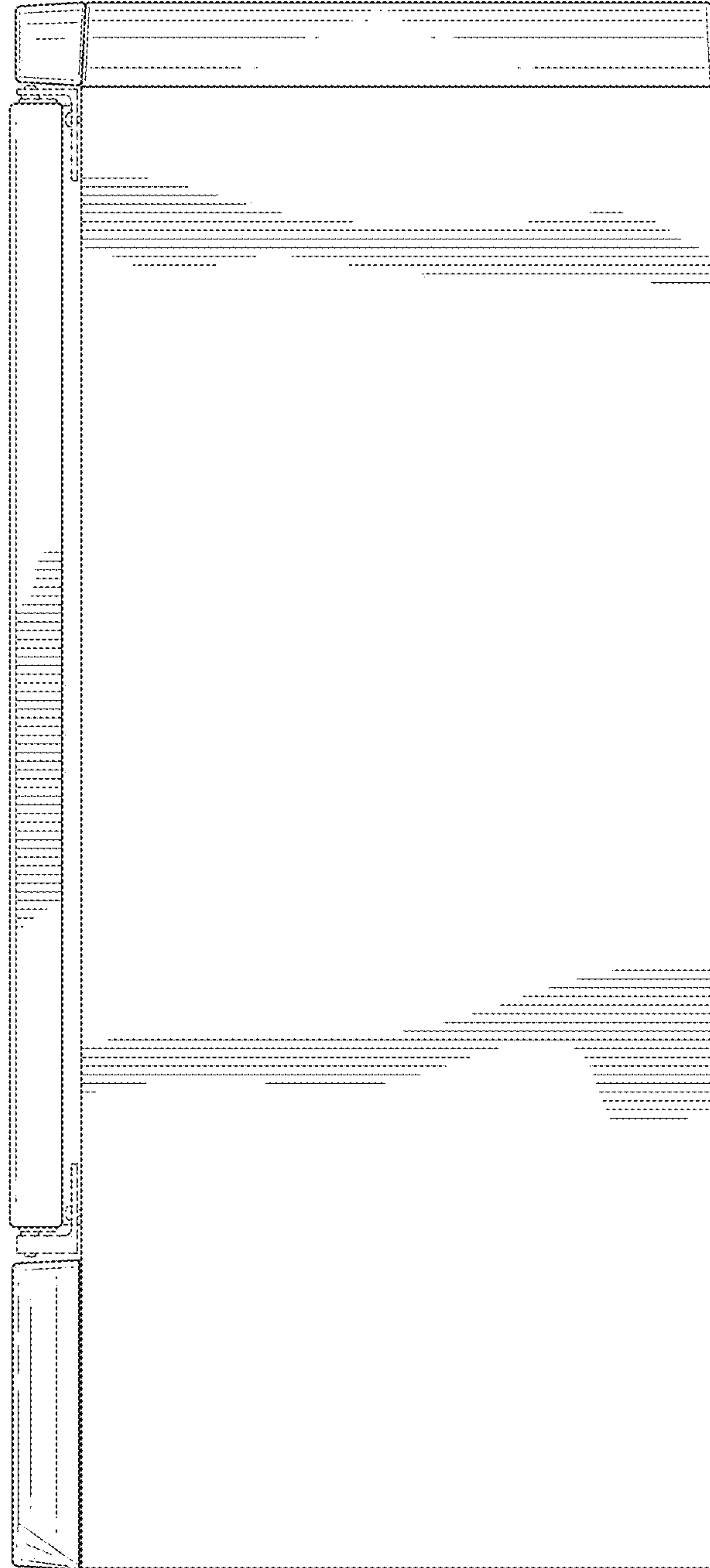

FIG. 3

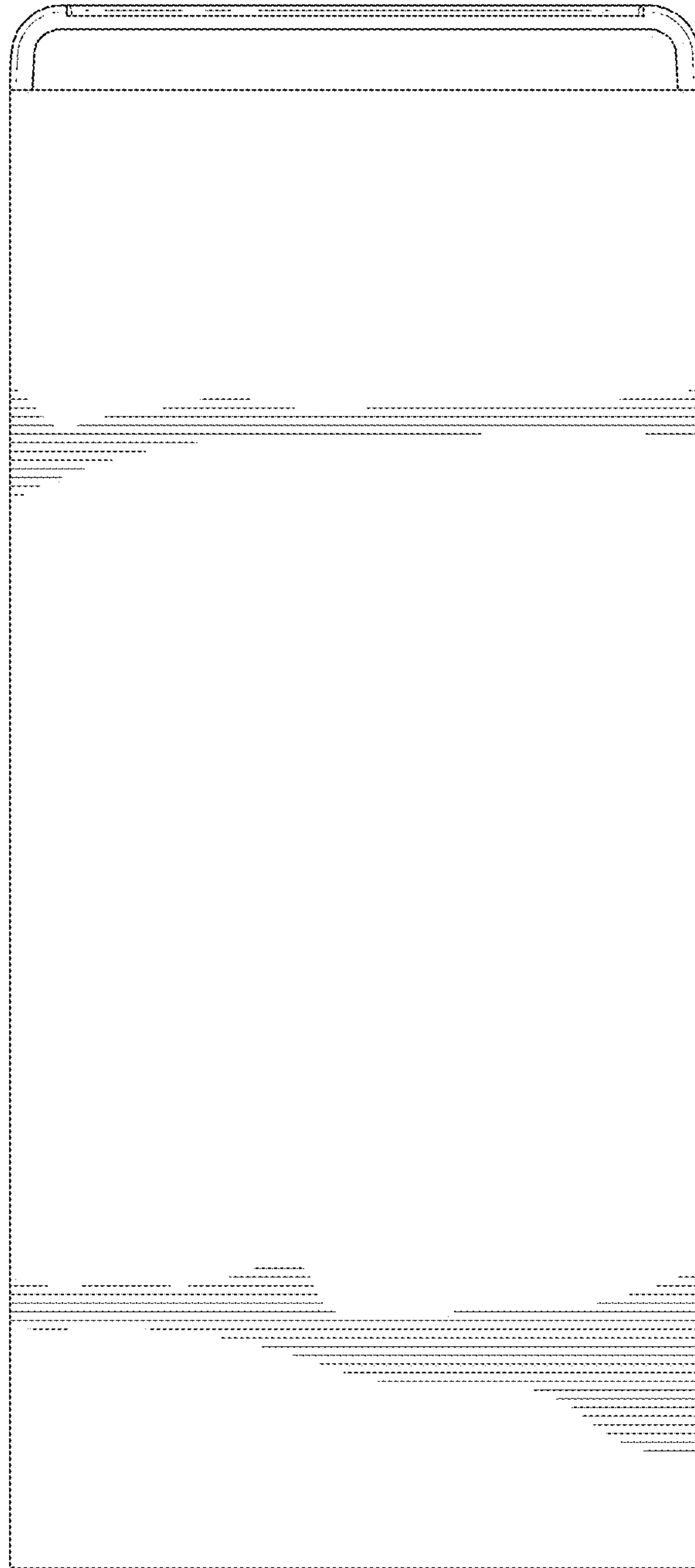

FIG. 4

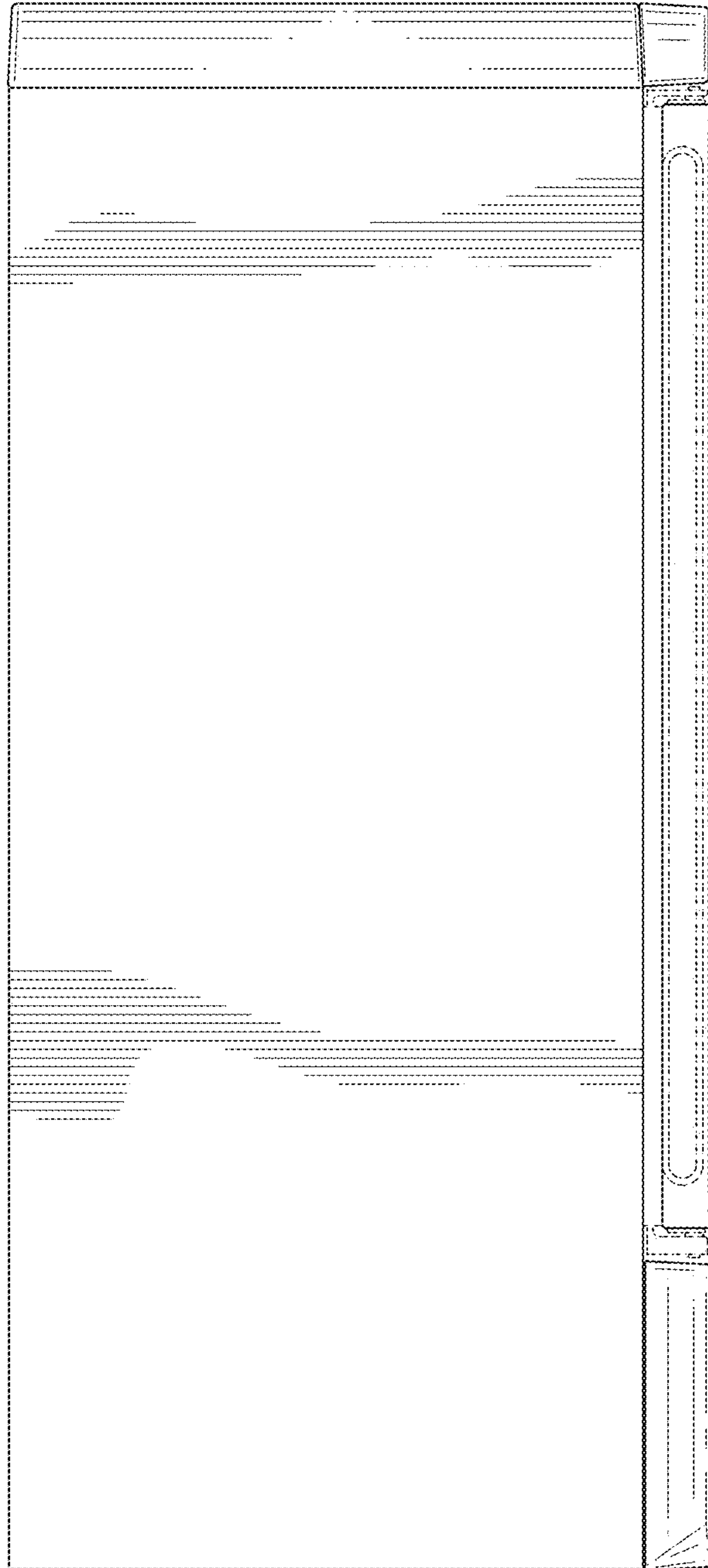

FIG. 5

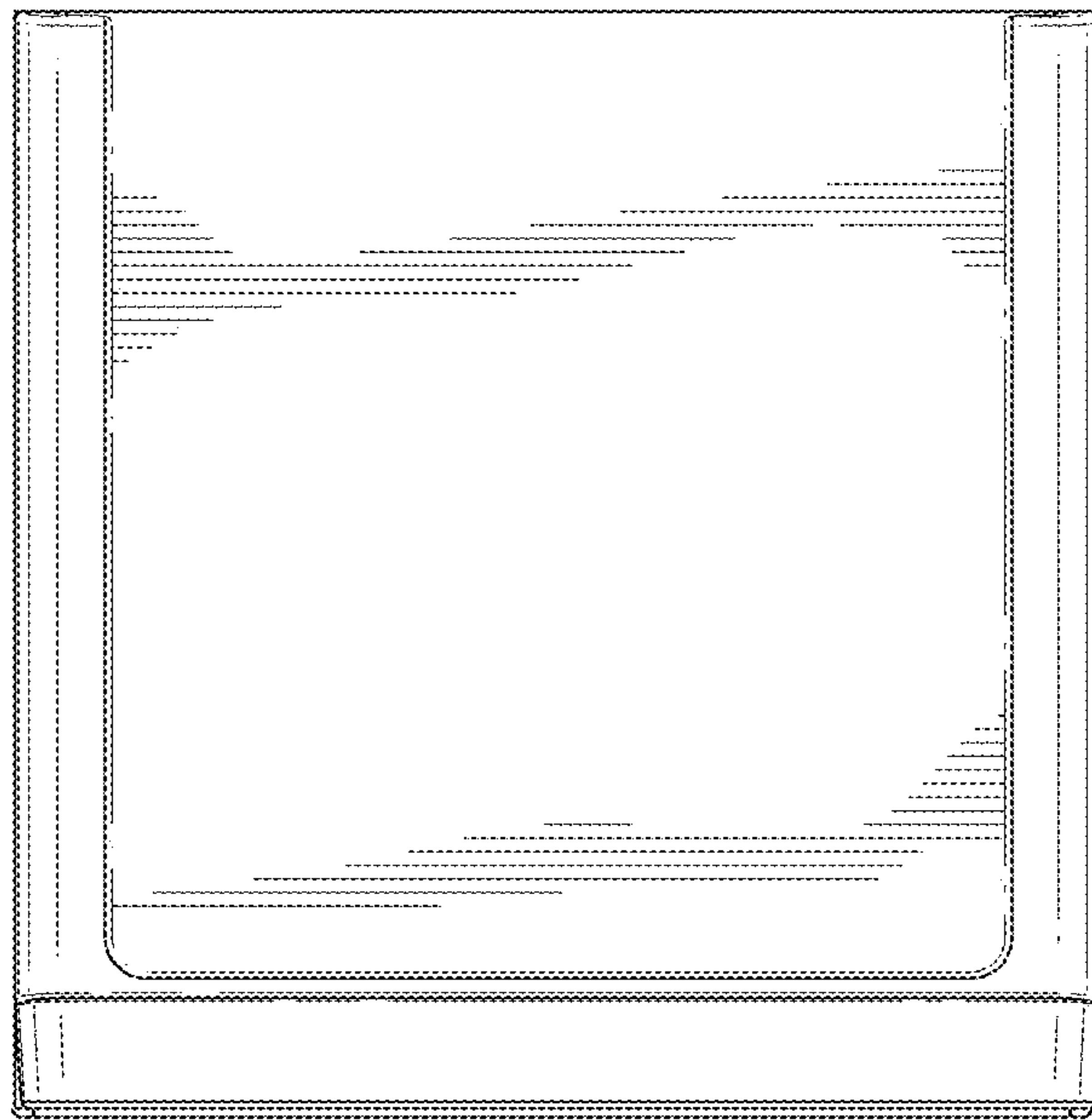

FIG. 6

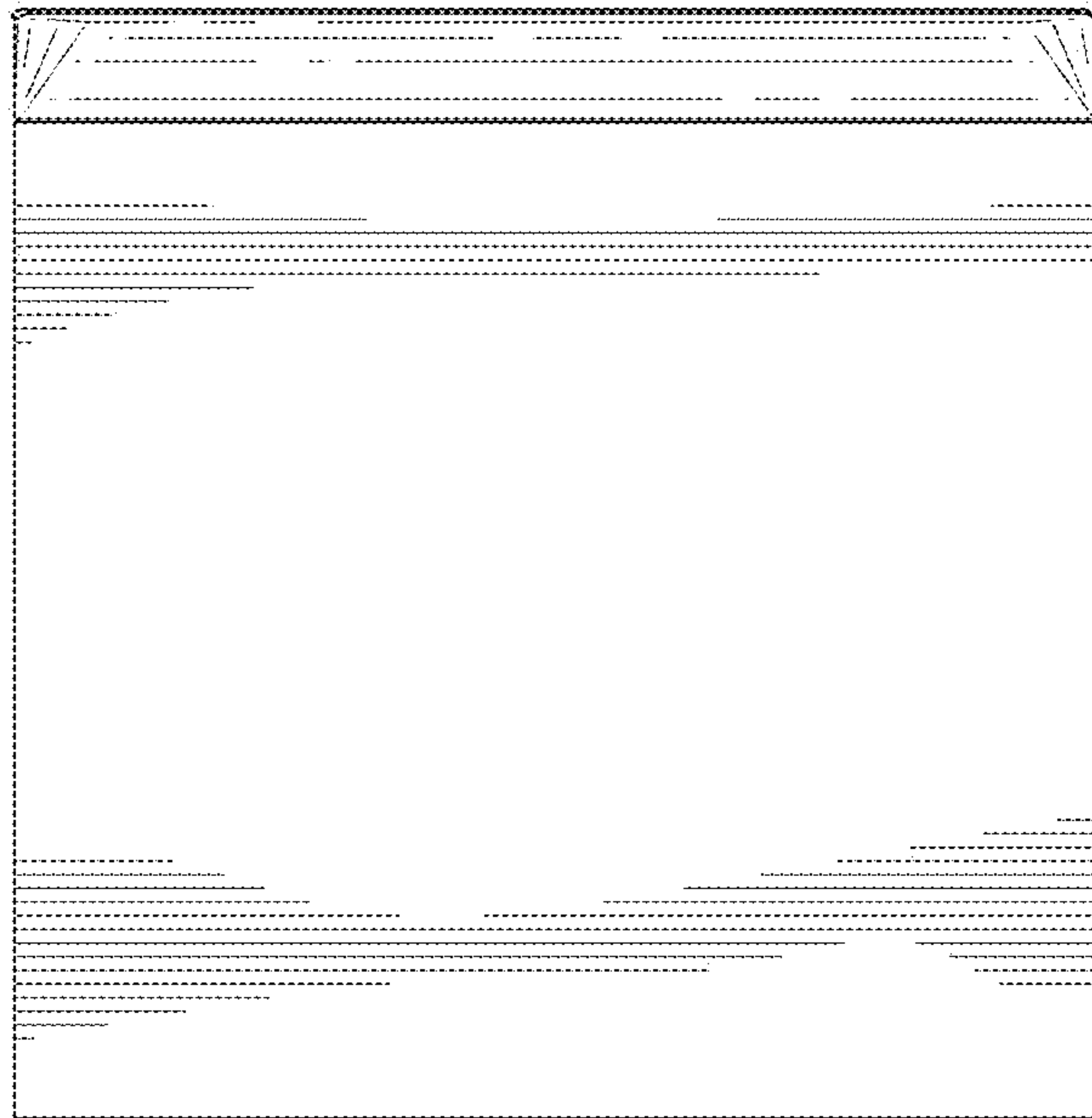

FIG. 7