



US00D736167S

(12) **United States Design Patent**
Bang et al.

(10) **Patent No.:** **US D736,167 S**

(45) **Date of Patent:** **** Aug. 11, 2015**

(54) **TELEVISION RECEIVER**

(56) **References Cited**

(71) Applicant: **SAMSUNG ELECTRONICS CO., LTD.**, Suwon-si (KR)

U.S. PATENT DOCUMENTS

(72) Inventors: **Sung-II Bang**, Seoul (KR); **Hae-Sung Park**, Seoul (KR)

D533,519 S *	12/2006	Ellison	D14/126
D570,804 S *	6/2008	Fujiki	D14/126
D573,560 S *	7/2008	Niitsu	D14/126
D605,149 S *	12/2009	Kim et al.	D14/126
D620,901 S *	8/2010	Won et al.	D14/126
D639,761 S *	6/2011	Chou et al.	D14/126
D661,271 S *	6/2012	Hwangbo et al.	D14/126
D676,816 S *	2/2013	Kim et al.	D14/126
D680,981 S *	4/2013	Kim et al.	D14/126
D682,231 S *	5/2013	Lee et al.	D14/126

(73) Assignee: **SAMSUNG ELECTRONICS CO., LTD.** (KR)

(**) Term: **14 Years**

* cited by examiner

(21) Appl. No.: **29/475,148**

Primary Examiner — Randall Gholson

(22) Filed: **Nov. 29, 2013**

(74) *Attorney, Agent, or Firm* — Cantor Colburn LLP

(30) **Foreign Application Priority Data**

(57) **CLAIM**

We claim, the ornamental design for a television receiver, as shown and described.

May 29, 2013 (KR) 30-2013-0027958

DESCRIPTION

(51) **LOC (10) Cl.** **14-03**

(52) **U.S. Cl.**
USPC **D14/126**

(58) **Field of Classification Search**
USPC D14/125–134, 239, 371, 136, 374–377,
D14/440, 450, 44, 448, 336, 342; 312/7.2;
348/836, 838, 180, 184, 325, 739;
248/917–924, 465; 345/104, 133, 156,
345/168, 87, 173; D21/329, 515, 577, 622,
D21/333, 433, 448, 452, 450, 331, 505;
D10/15, 26; 446/484, 175, 356;
D6/700, 701, 682.3
CPC H04N 5/50; H05K 5/02
See application file for complete search history.

FIG. 1 is a front perspective view of a television receiver showing our new design;
FIG. 2 is a front elevation view thereof;
FIG. 3 is a rear elevation view thereof;
FIG. 4 is a left side elevation view thereof;
FIG. 5 is a right side elevation view thereof;
FIG. 6 is a top plan view thereof;
FIG. 7 is a bottom plan view thereof; and,
FIG. 8 is a rear perspective view thereof.
The broken lines depict portions of the television receiver that form no part of the claimed design.
The shade lines in the figures show contour and not surface ornamentation.

1 Claim, 8 Drawing Sheets

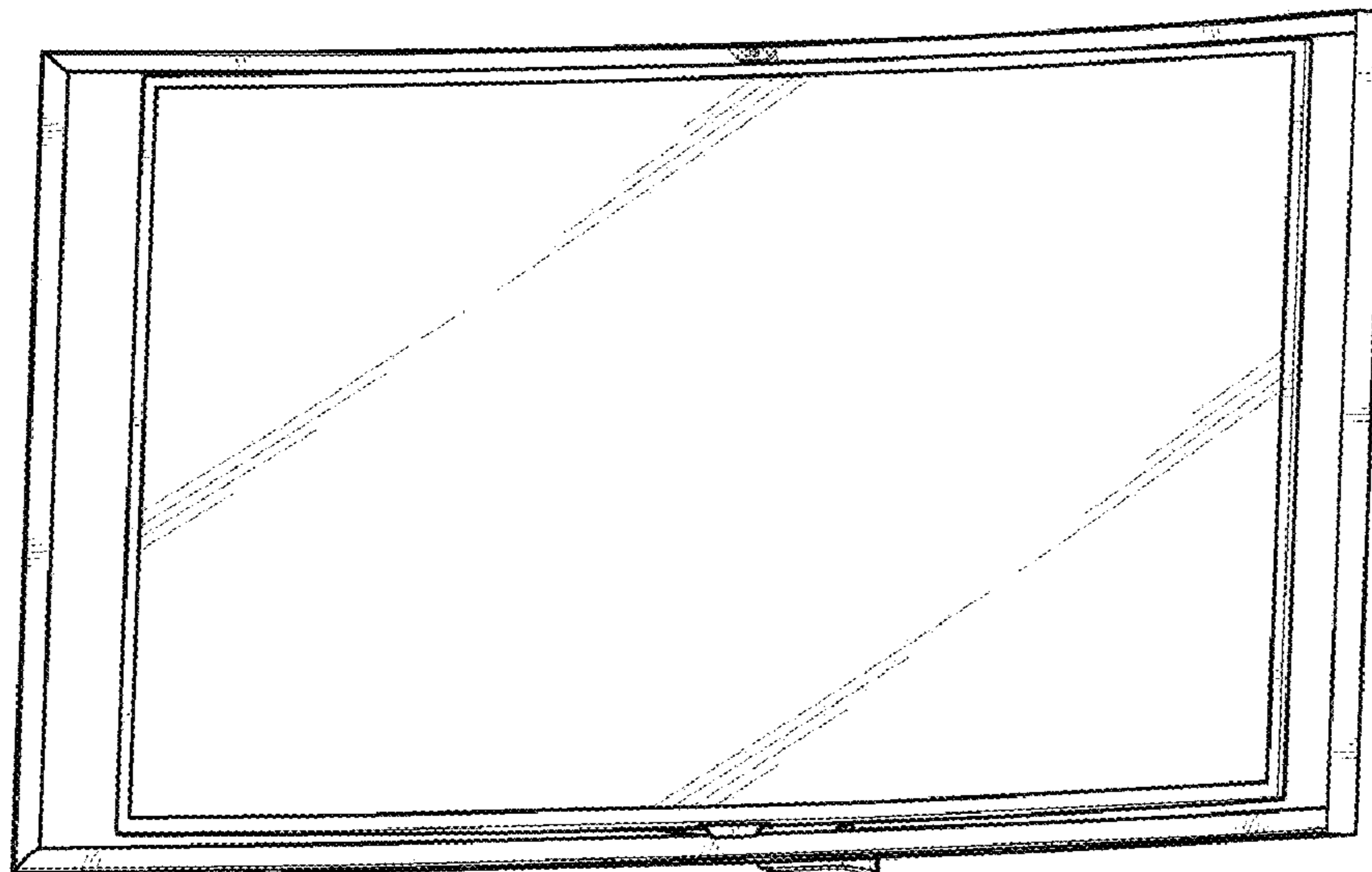

FIG. 1

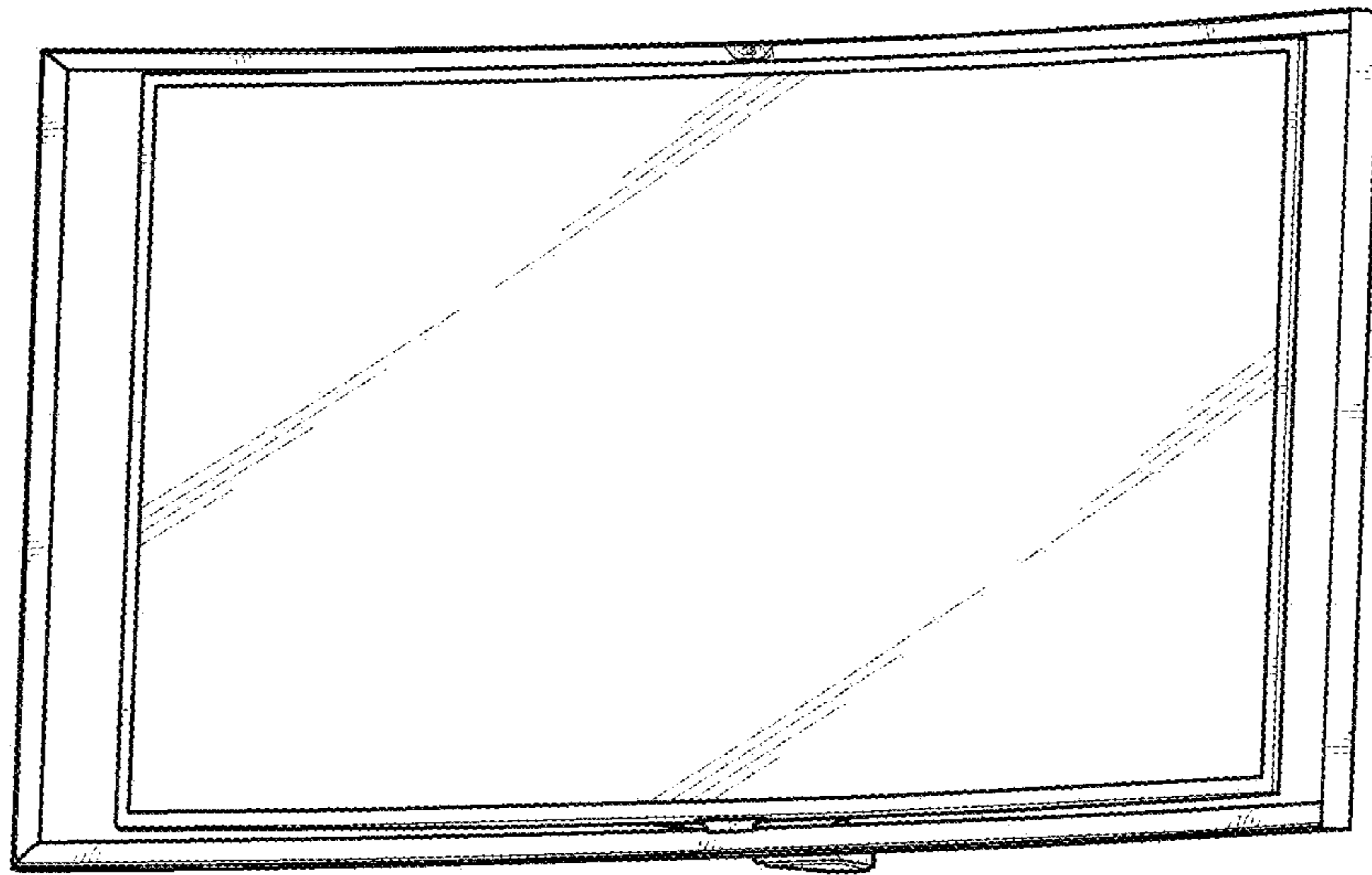

FIG. 2

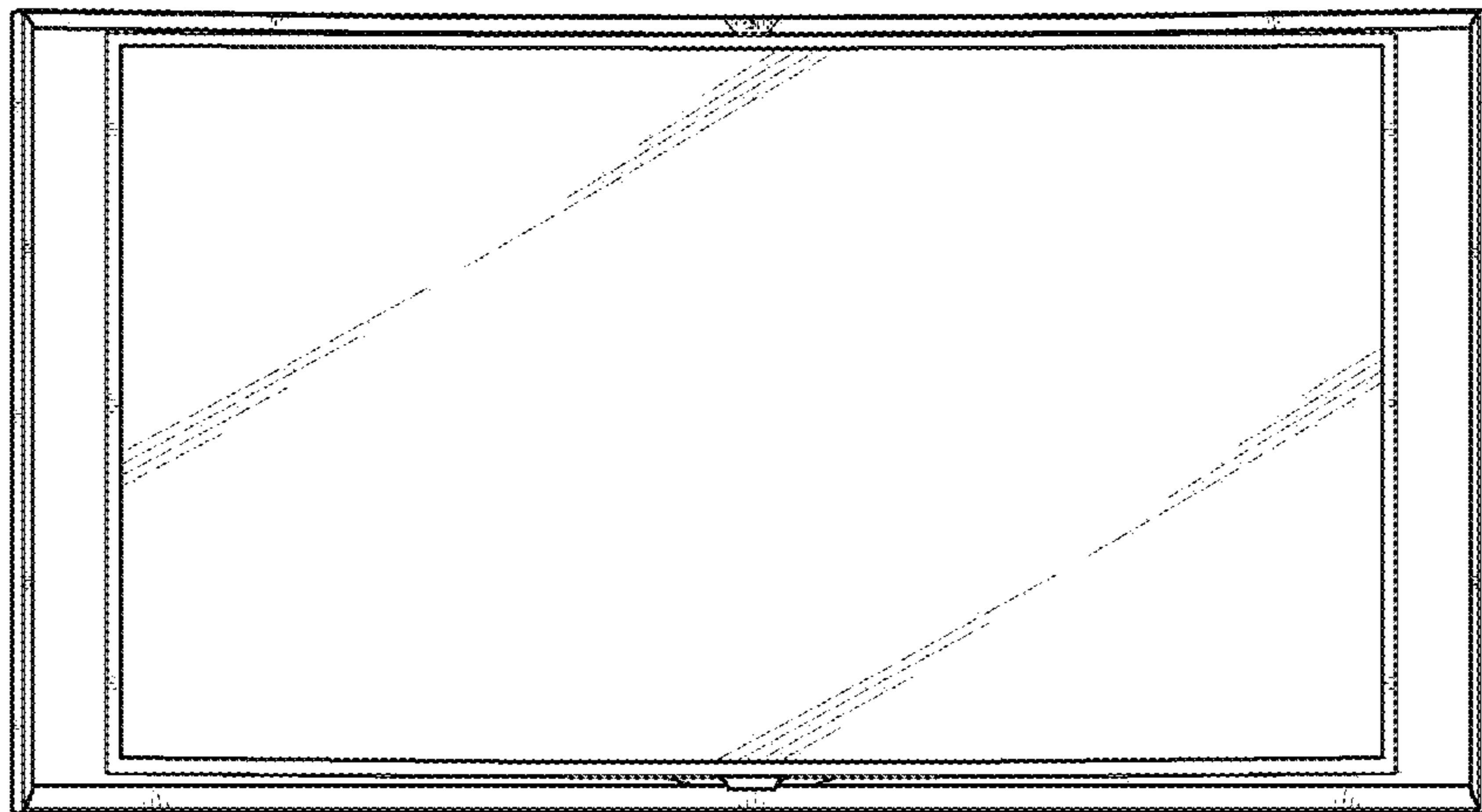

FIG. 3

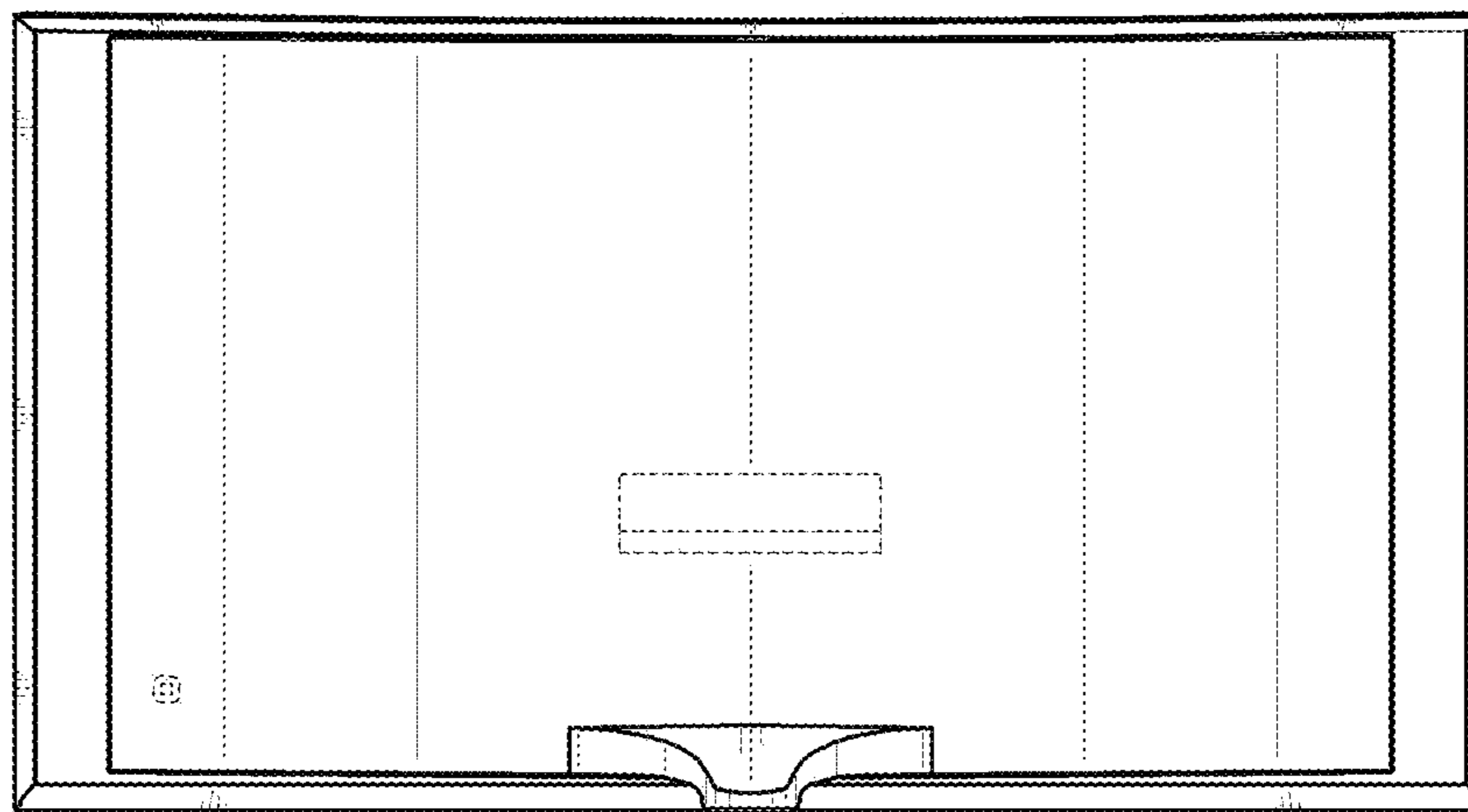

FIG. 4

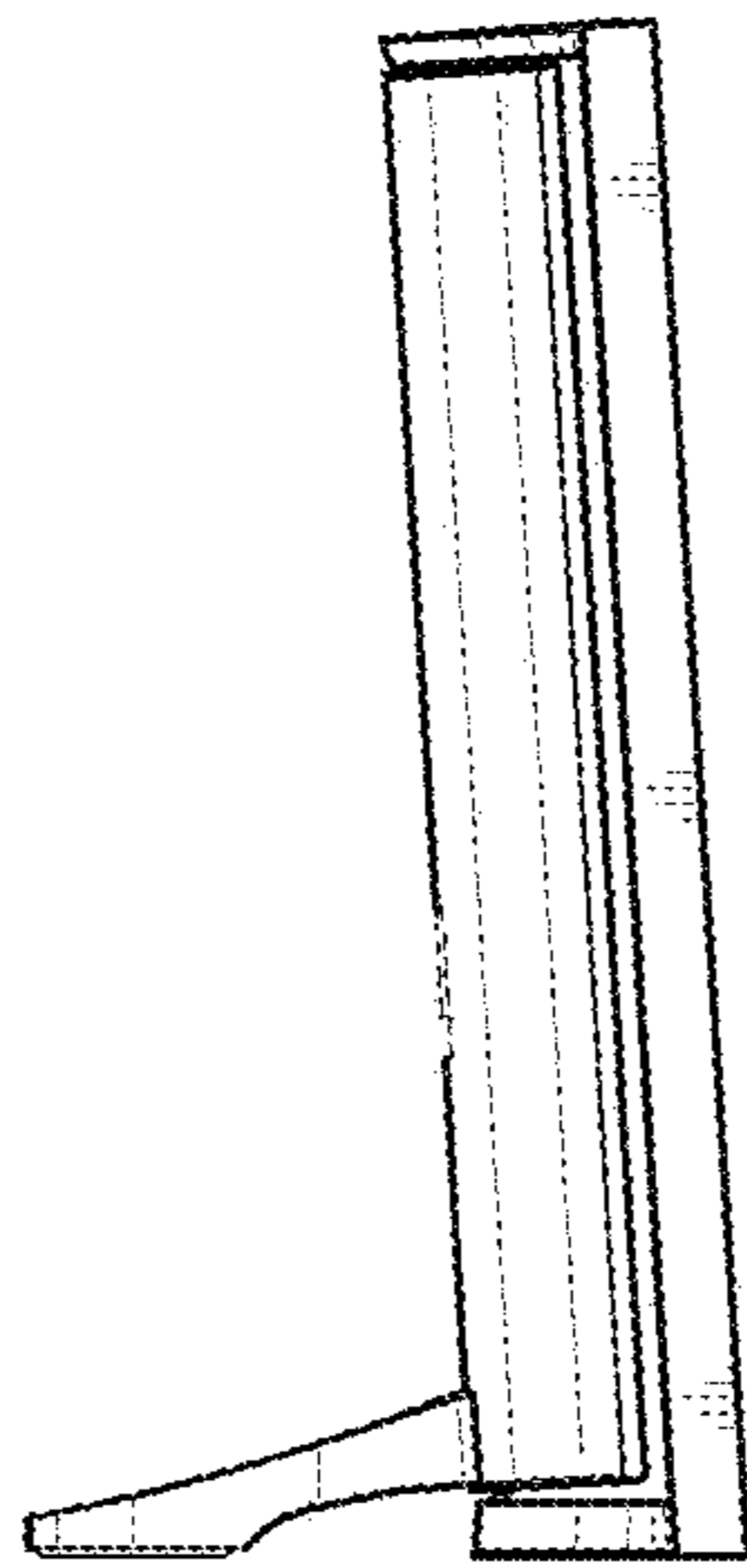

FIG. 5

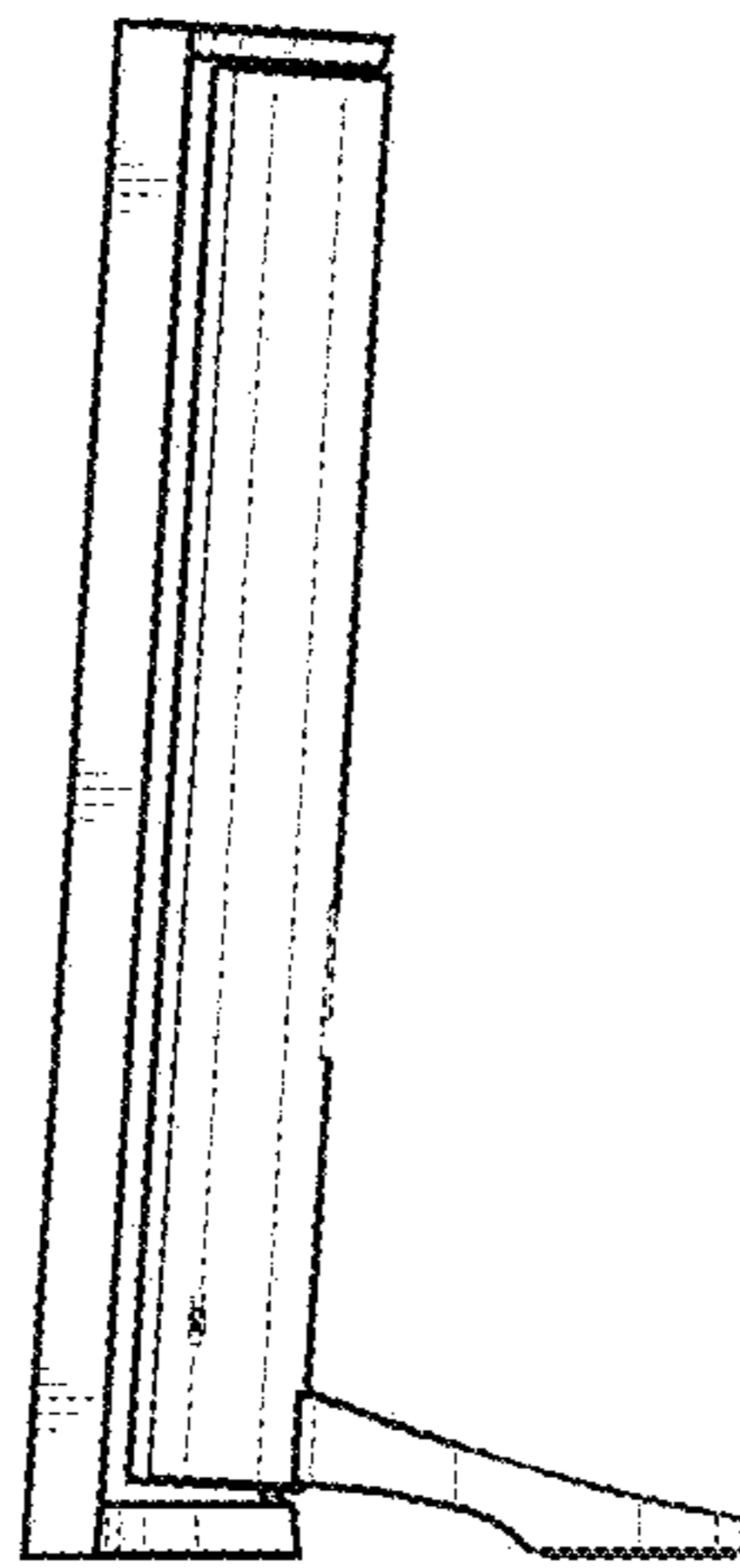

FIG. 6

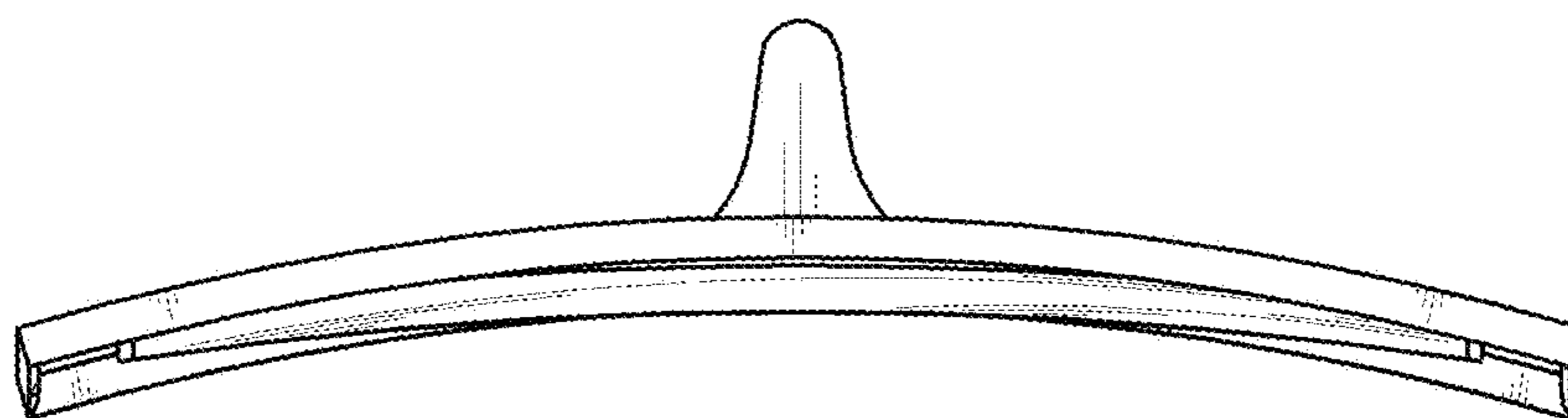

FIG. 7

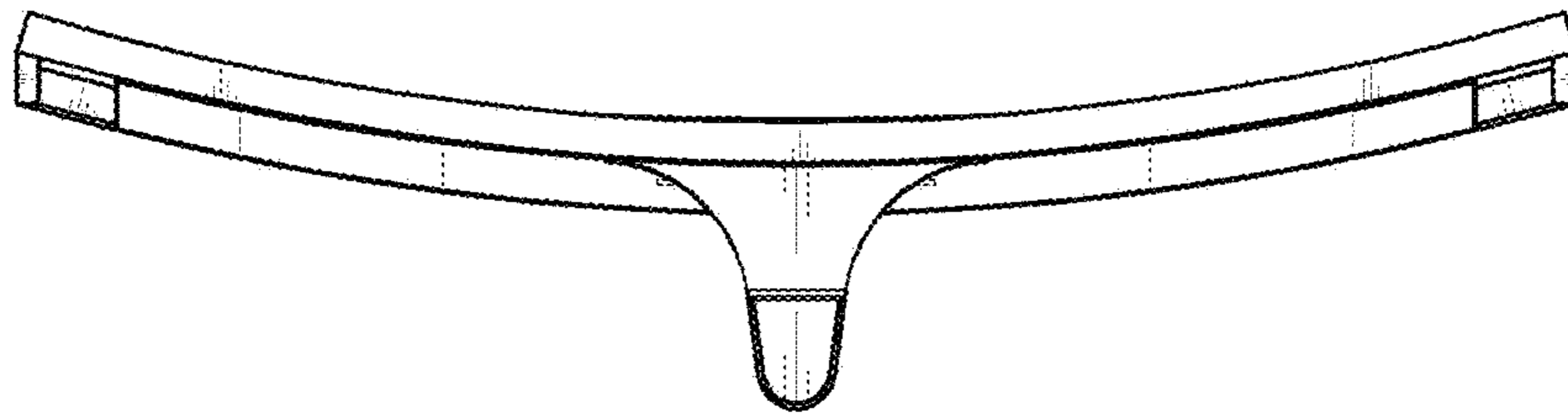

FIG. 8

