



US00D736150S

(12) **United States Design Patent**  
**Liu**

(10) **Patent No.:** **US D736,150 S**

(45) **Date of Patent:** **\*\* Aug. 11, 2015**

(54) **USB CHARGER**

(71) Applicant: **Qiuming Liu**, Guangdong (CN)

(72) Inventor: **Qiuming Liu**, Guangdong (CN)

(73) Assignee: **KIMREE HI-TECH INC.**, Road Town,  
Tortola (VG)

(\*\*) Term: **14 Years**

(21) Appl. No.: **29/466,895**

(22) Filed: **Sep. 12, 2013**

(30) **Foreign Application Priority Data**

Aug. 14, 2013 (CN) ..... 2013 3 0388732

(51) **LOC (10) Cl.** ..... **13-02**

(52) **U.S. Cl.**  
USPC ..... **D13/108**; D14/480.1

(58) **Field of Classification Search**  
USPC ..... D13/107–110, 118–119, 184, 199;  
D14/251, 253, 432, 434, 434.1,  
D14/480.1–480.7, 484.1; 320/107–115;  
D27/137, 186, 193, 194; 131/328–329;  
361/679.31, 679.33, 679.4, 752;  
711/100, 115

CPC ..... Y02E 60/12; Y02T 90/14; Y02T 90/122;  
Y02T 90/128; Y02T 90/163; H02J 7/025;  
H02J 7/0042; H02J 7/0044; H02J 7/0045;  
H02J 7/0003; H01F 38/14; H01R 13/6675;  
H01M 2/1022; H01M 2/1055; H01M 10/44;  
H01M 10/46; H01M 10/425; B60L 11/182;  
A24F 47/008; G06K 19/07732; H05K 5/0278

See application file for complete search history.

(56) **References Cited**

**U.S. PATENT DOCUMENTS**

7,035,110 B1 \* 4/2006 Wang et al. .... 361/737  
7,296,345 B1 \* 11/2007 Wang et al. .... 29/832  
D558,145 S \* 12/2007 Stavoe et al. .... D13/154  
D579,934 S \* 11/2008 Okamoto et al. .... D14/435.1

D582,419 S \* 12/2008 Sheba et al. .... D14/480.5  
D595,223 S \* 6/2009 Yamamoto et al. .... D13/108  
D604,247 S \* 11/2009 Zhao et al. .... D13/147  
D623,145 S \* 9/2010 Amidon et al. .... D13/154  
D647,100 S \* 10/2011 Huang ..... D14/480.7  
D658,666 S \* 5/2012 Fukuoka et al. .... D14/480.5  
D675,575 S \* 2/2013 Izen et al. .... D13/147  
D675,993 S \* 2/2013 Izen et al. .... D13/147

(Continued)

*Primary Examiner* — Rosemary K Tarcza

(74) *Attorney, Agent, or Firm* — Locke Lord LLP; Tim  
Tingkang Xia, Esq.

(57) **CLAIM**

The ornamental design for a USB charger, as shown and  
described.

**DESCRIPTION**

FIG. 1 is a front elevational view of an embodiment of a USB  
charger;

FIG. 2 is a rear elevational view of the embodiment of the  
USB charger;

FIG. 3 is a top plan view of the embodiment of the USB  
charger;

FIG. 4 is a bottom plan view of the embodiment of the USB  
charger;

FIG. 5 is a left side elevational view of the embodiment of the  
USB charger;

FIG. 6 is a right side elevational view of the embodiment of  
the USB charger;

FIG. 7 is a first perspective view of the embodiment of the  
USB charger;

FIG. 8 is a second perspective view of the embodiment of the  
USB charger;

FIG. 9 is a first reference view of the embodiment of the USB  
charger; and,

FIG. 10 is a second reference view of the embodiment of the  
USB charger.

The broken lines shown in the drawings are included for the  
purpose of illustrating environmental structure and form no  
part of the claimed design.

**1 Claim, 4 Drawing Sheets**

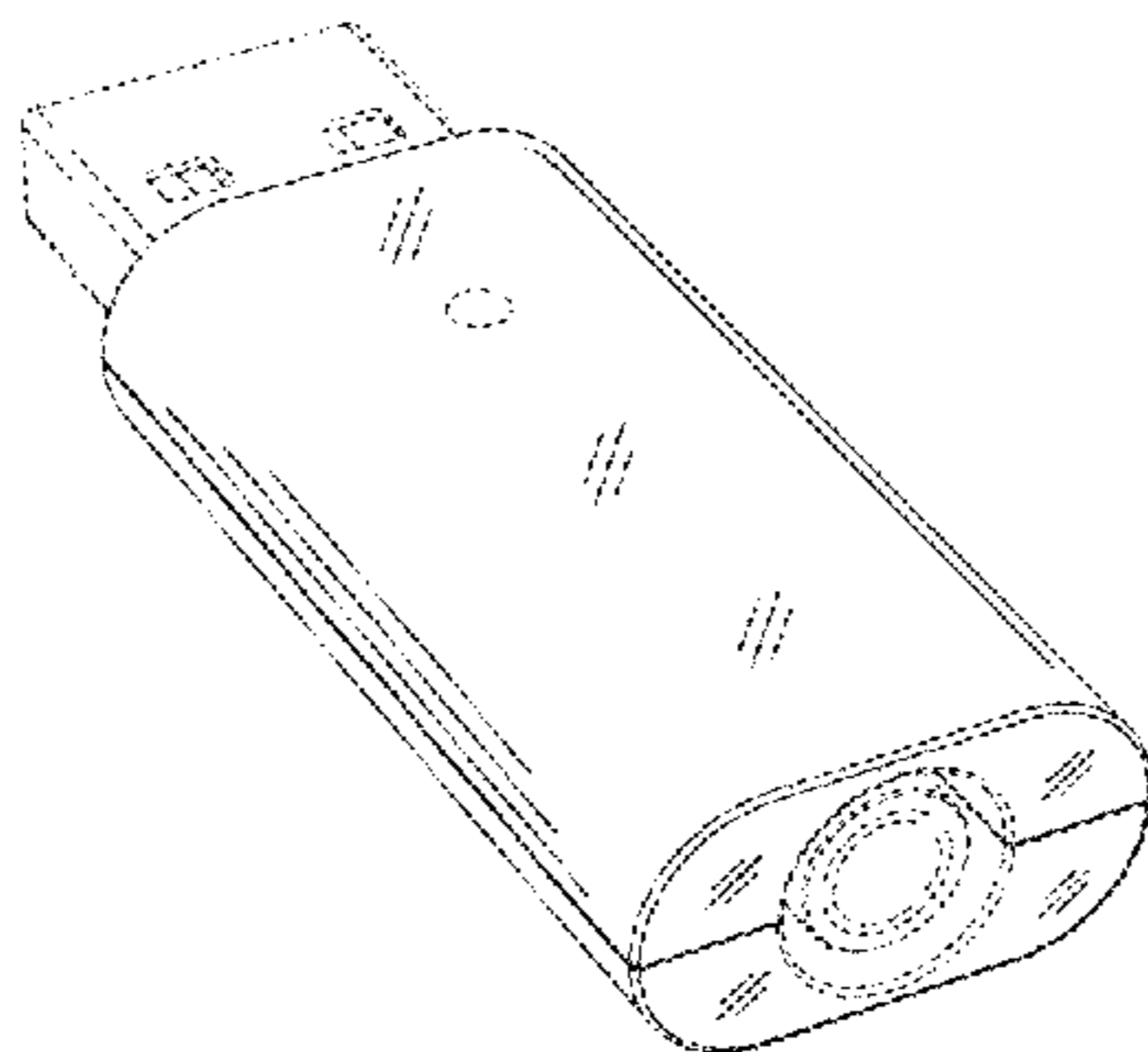

(56)

**References Cited**

U.S. PATENT DOCUMENTS

D678,841 S \* 3/2013 Choi et al. .... D13/147  
D679,248 S \* 4/2013 Choi et al. .... D13/147  
D679,249 S \* 4/2013 Choi et al. .... D13/147  
D679,250 S \* 4/2013 Choi et al. .... D13/147  
D699,188 S \* 2/2014 Akana et al. .... D13/147  
D703,145 S \* 4/2014 Akana et al. .... D13/147

D707,180 S \* 6/2014 Yi et al. .... D13/147  
D711,891 S \* 8/2014 Emami et al. .... D14/480.5  
D713,350 S \* 9/2014 Akana et al. .... D13/147  
2004/0233629 A1\* 11/2004 Wang et al. .... 361/684  
2007/0047359 A1\* 3/2007 He et al. .... 365/207  
2008/0144270 A1\* 6/2008 Dal Porto et al. .... 361/684  
2010/0193583 A1\* 8/2010 Tartavull et al. .... 235/375  
2010/0281209 A1\* 11/2010 Ni et al. .... 711/103

\* cited by examiner

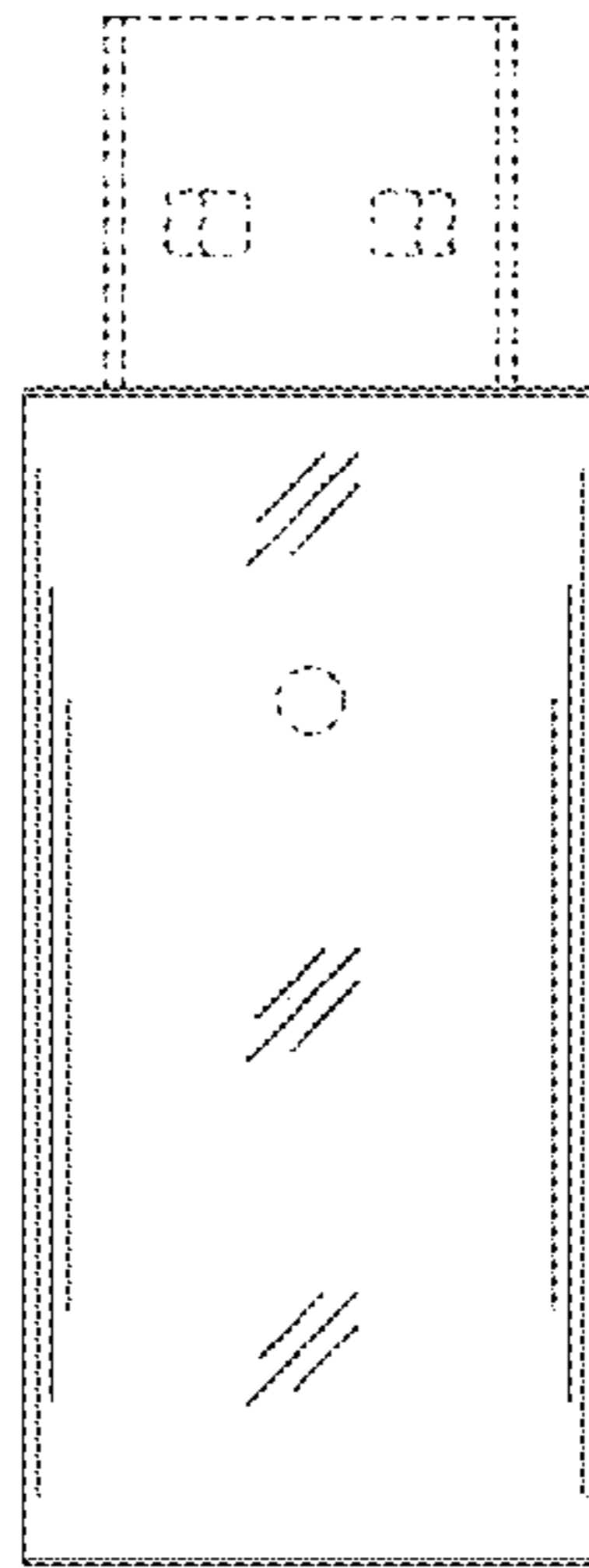

Fig. 1

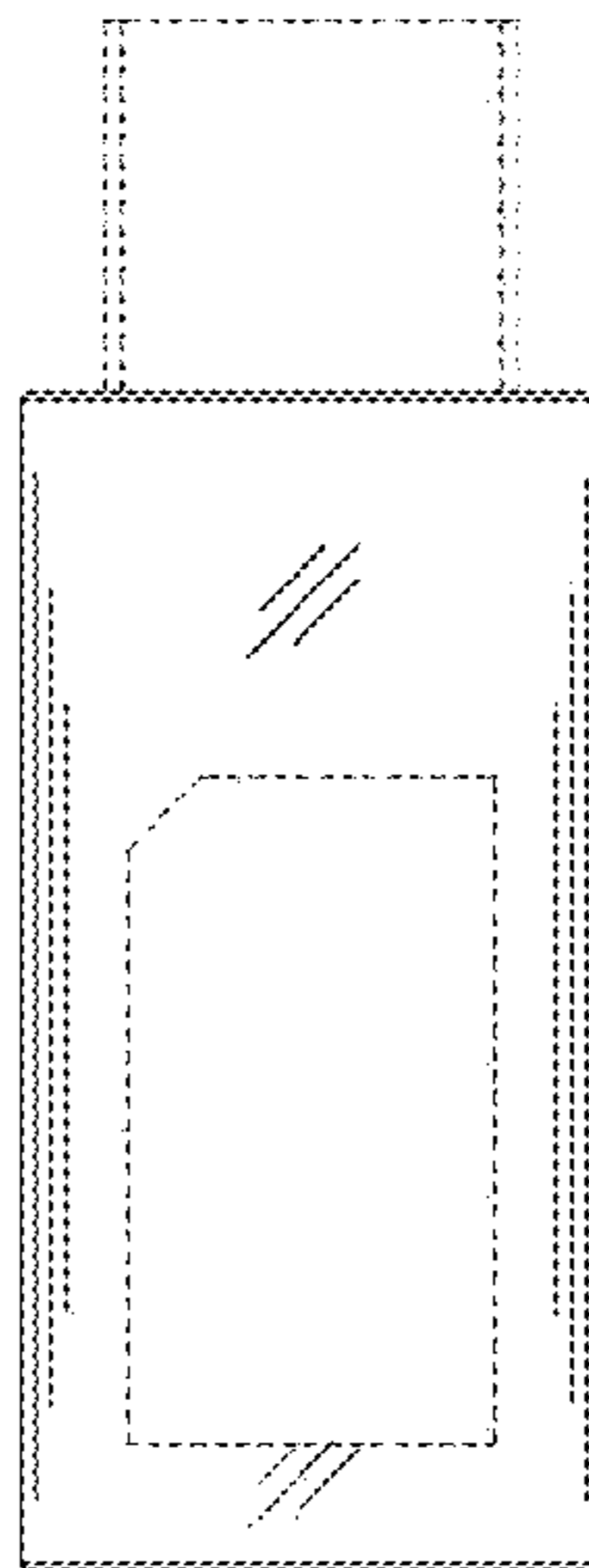

Fig. 2

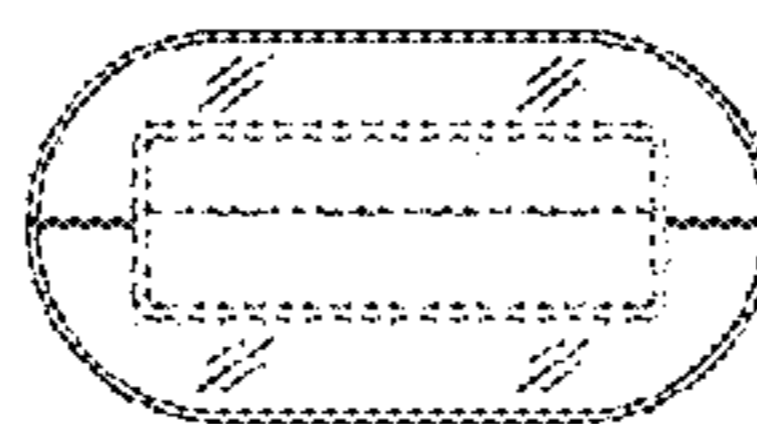

Fig. 3

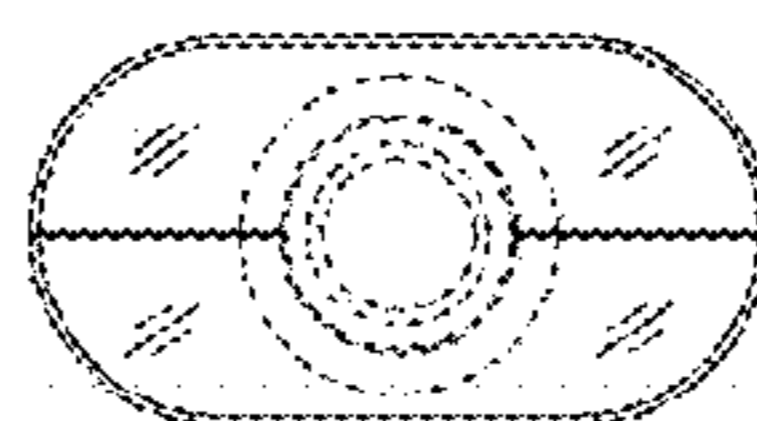

Fig. 4

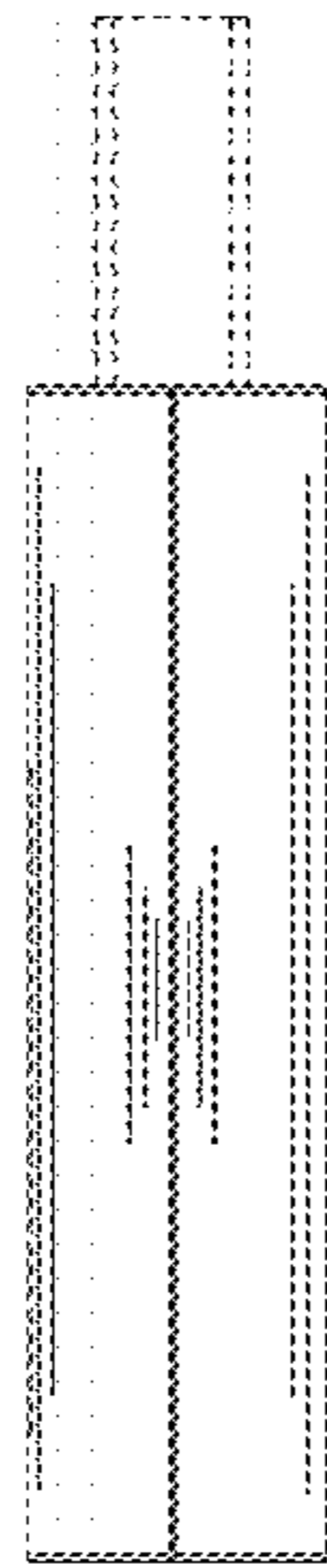

Fig. 5

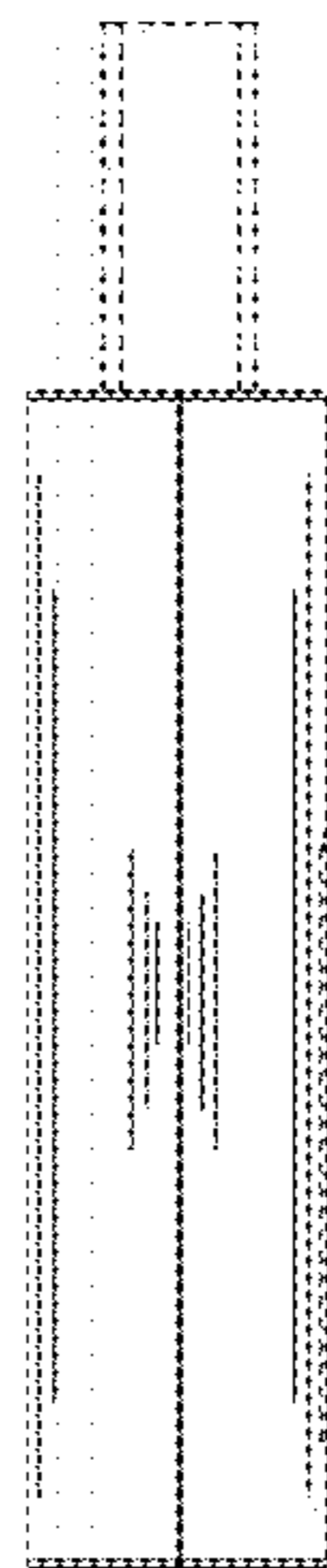

Fig. 6

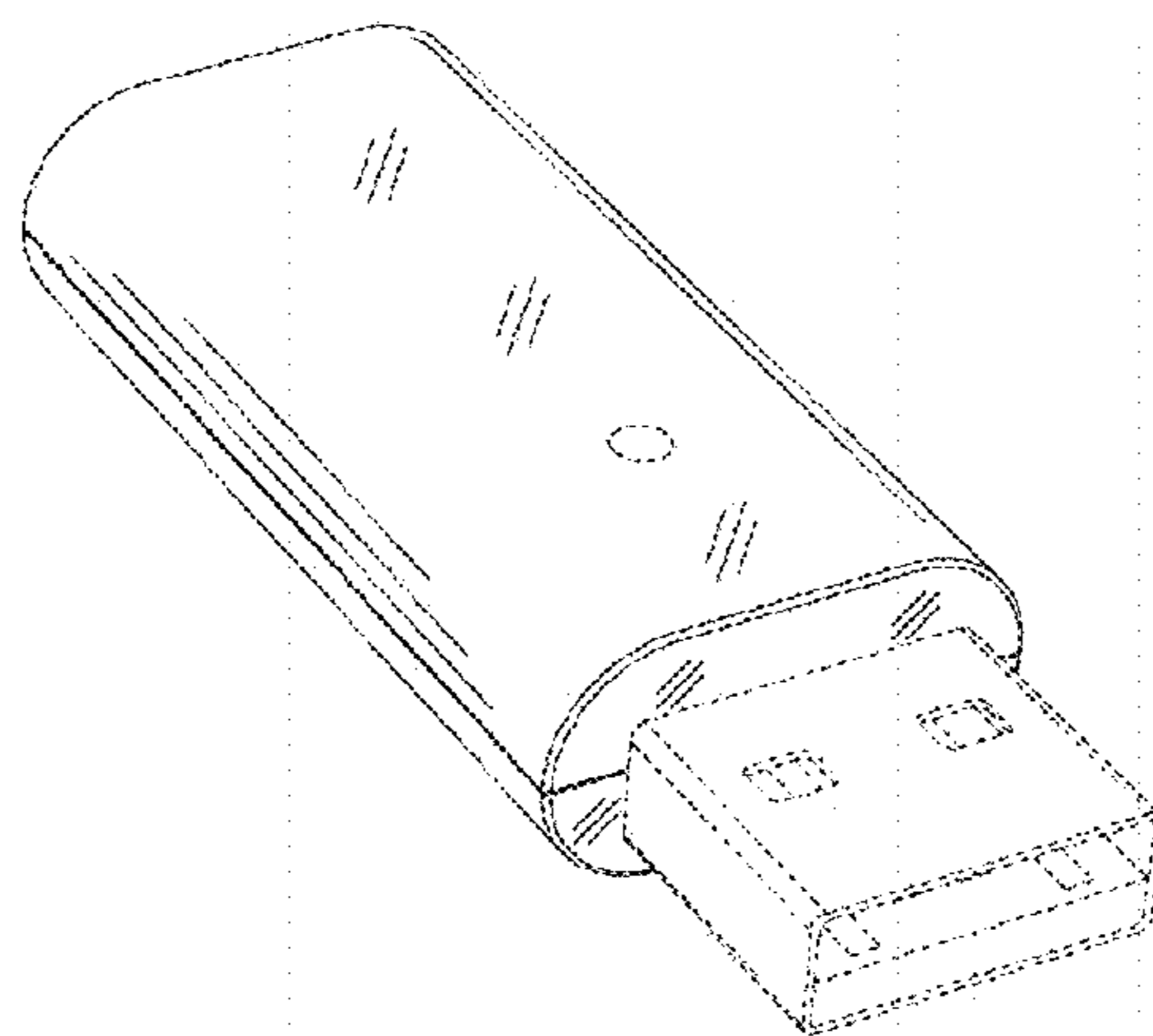

Fig. 7

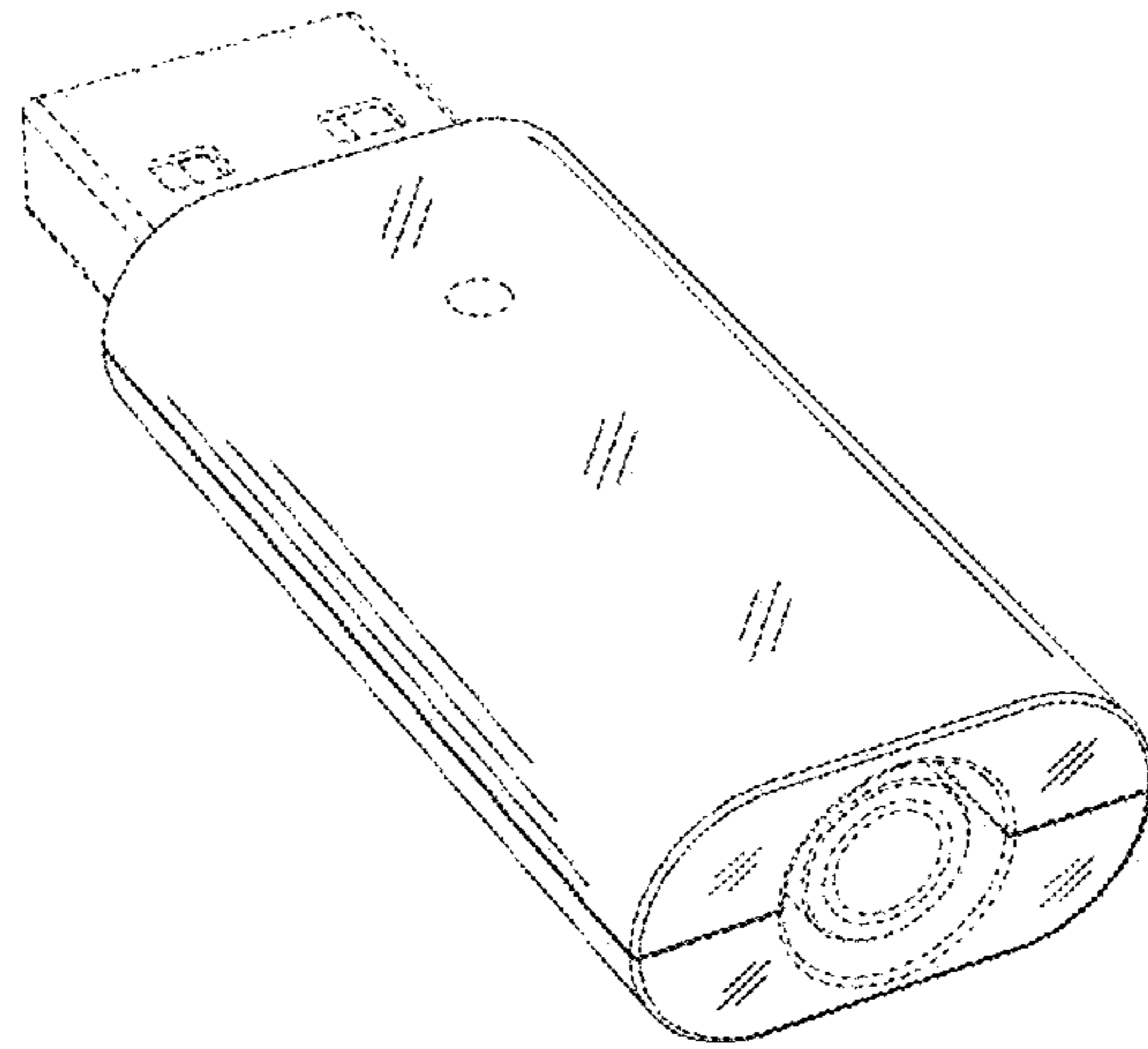

Fig. 8

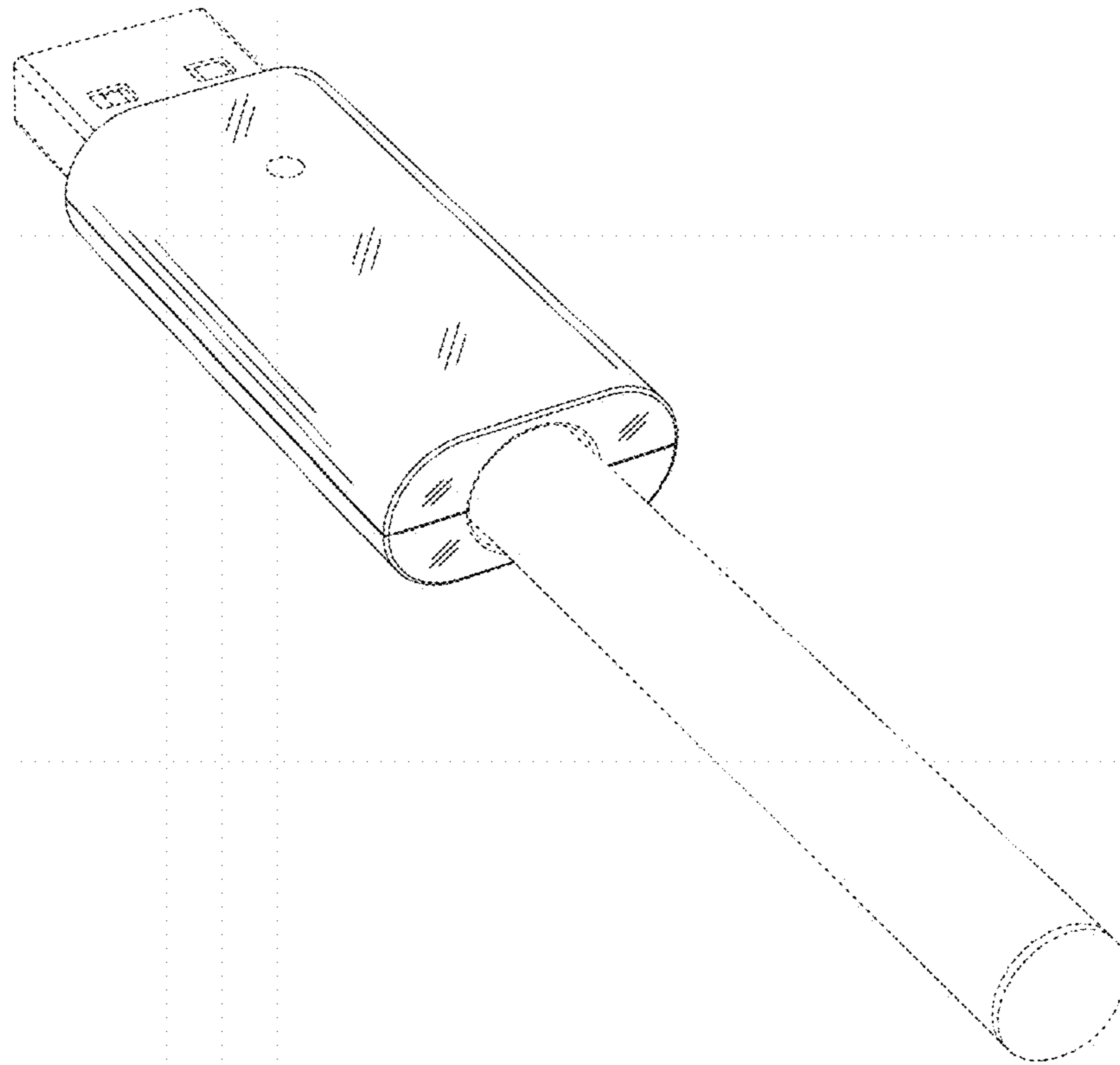

Fig. 9

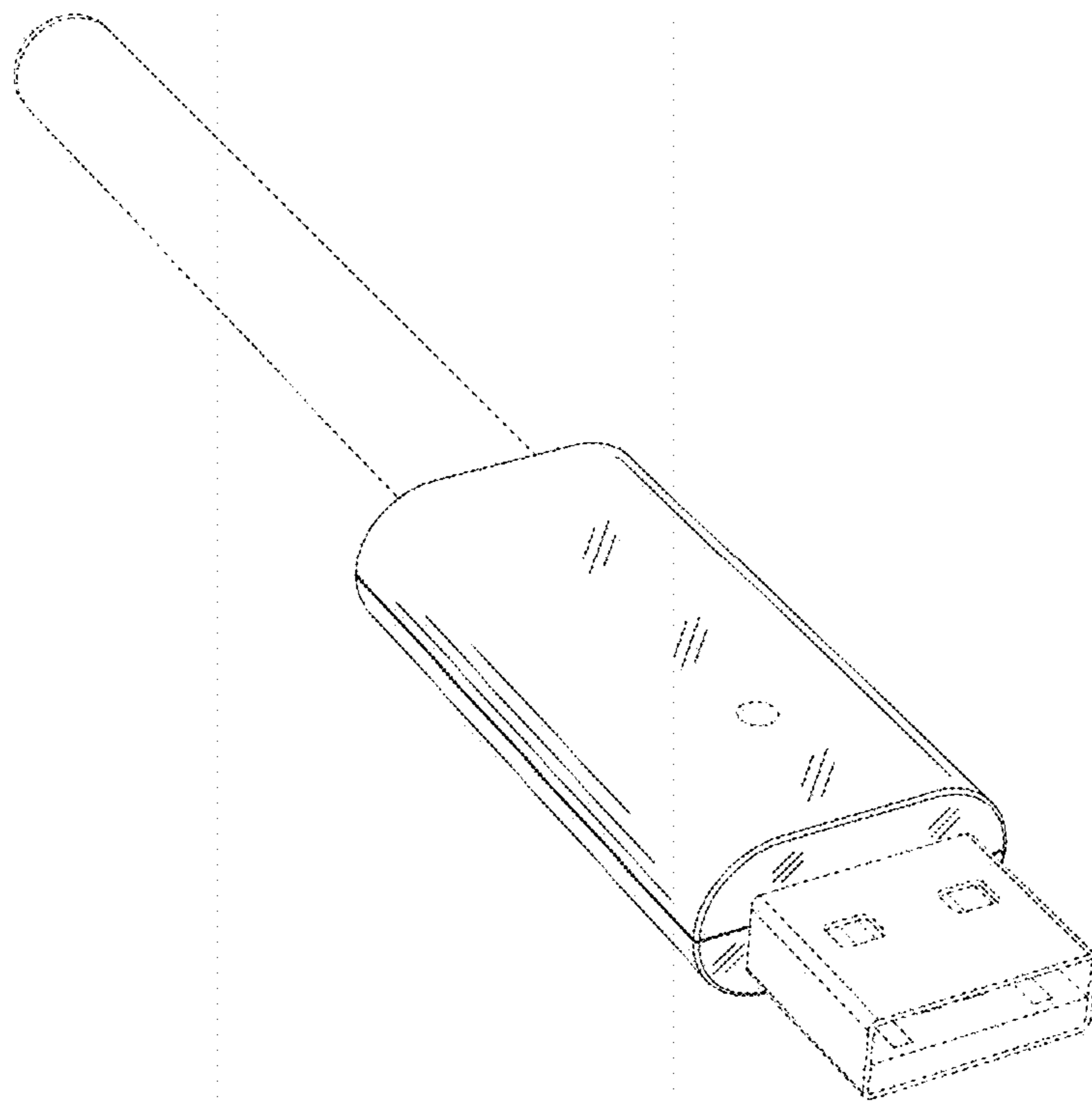

Fig. 10