

US00D736116S

(12) **United States Design Patent**
Schoenbeck et al.

(10) **Patent No.:** **US D736,116 S**
(45) **Date of Patent:** **** Aug. 11, 2015**

(54) **CONNECTION ASSEMBLY**

(71) Applicant: **ST. ANTONI LLC**, Woodland Hills, CA (US)

(72) Inventors: **Dewi Schoenbeck**, Calabasas, CA (US);
John Schoenbeck, Calabasas, CA (US)

(**) Term: **14 Years**

(21) Appl. No.: **29/494,542**

(22) Filed: **Jun. 20, 2014**

(51) **LOC (10) Cl.** **02-07**

(52) **U.S. Cl.**
USPC **D11/220**

(58) **Field of Classification Search**

USPC D11/220, 22, 226, 218; 24/1, 681,
24/689-691, 18, 683, 108, 674, 692,
24/621-623, 671, 662, 618; 292/319;
D8/382
CPC A44B 1/08; A44B 17/0088
See application file for complete search history.

(56) **References Cited**

U.S. PATENT DOCUMENTS

4,165,555	A	8/1979	Boxer et al.	
5,189,767	A *	3/1993	Reitsma	24/633
D382,223	S	8/1997	Harrison	
5,918,318	A	7/1999	Jones	
5,970,524	A	10/1999	Becker et al.	
6,185,751	B1	2/2001	Mason	
D442,113	S	5/2001	Nisguretsky	
D503,646	S	4/2005	Rapport	
6,990,694	B2	1/2006	Poole	
D552,003	S *	10/2007	Lecut	D11/3
D579,194	S	10/2008	Caylor	
D613,938	S	4/2010	Alexander	
D627,146	S	11/2010	Kantor et al.	
D631,780	S *	2/2011	Levy	D11/87
7,905,111	B2 *	3/2011	Saltz	63/3
D653,153	S	1/2012	Froehlich	

(Continued)

OTHER PUBLICATIONS

Notice of Allowance for U.S. Appl. No. 29/494,543 mailed Dec. 8, 2014.

(Continued)

Primary Examiner — Zenia Bennett

(74) *Attorney, Agent, or Firm* — Brooks Acordia IP Law, PC; Douglas N. Larson

(57) **CLAIM**

We claim the ornamental design for a connection assembly, substantially as shown and described.

DESCRIPTION

FIG. 1 is a perspective view of a connection assembly showing our new design;
FIG. 2 is a front plan view thereof;
FIG. 3 is a left side elevational view thereof;
FIG. 4 is a right side elevational view thereof;
FIG. 5 is a top view thereof;
FIG. 6 is a bottom view thereof;
FIG. 7 is a perspective view of a connection assembly showing a second embodiment of our new design;
FIG. 8 is a front plan view thereof;
FIG. 9 is a left side elevational view thereof;
FIG. 10 is a right side elevational view thereof;
FIG. 11 is a top view thereof;
FIG. 12 is a bottom view thereof;
FIG. 13 is a perspective view of a connection assembly showing a third embodiment of our new design;
FIG. 14 is a front plan view thereof;
FIG. 15 is a left side elevational view thereof;
FIG. 16 is a right side elevational view thereof;
FIG. 17 is a top view thereof; and,
FIG. 18 is a bottom view thereof.
The broken lines shown in the drawings are included for the purpose of illustrating environmental structure and form no part of the claimed design.

1 Claim, 6 Drawing Sheets

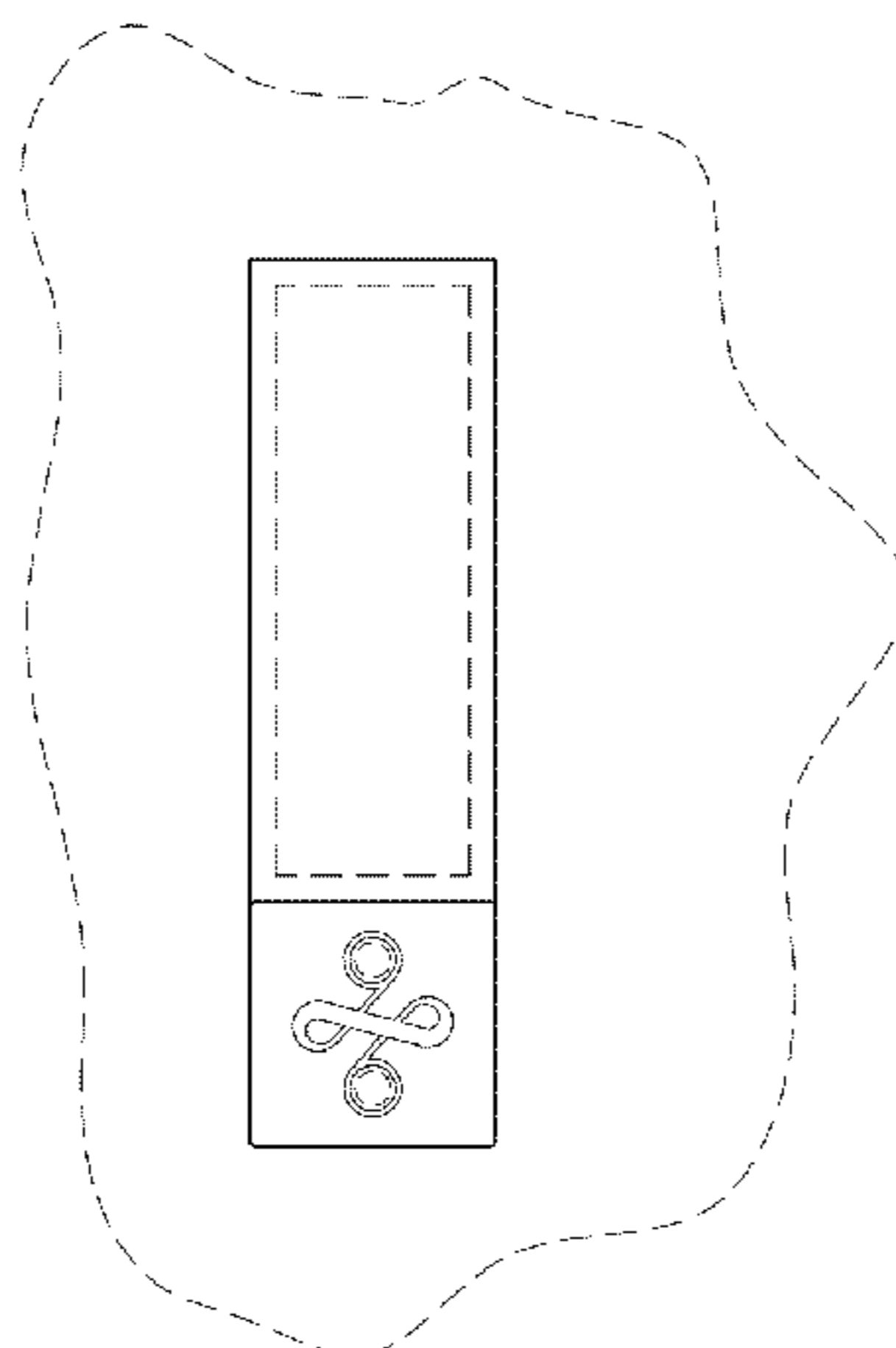

(56)

References Cited

U.S. PATENT DOCUMENTS

D668,576	S *	10/2012	Outland	D11/79
D673,874	S *	1/2013	Long et al.	D11/87
8,359,671	B1	1/2013	Glass et al.		
D705,695	S	5/2014	Wall		
D707,584	S *	6/2014	Webb	D11/87
D712,773	S *	9/2014	Mounce	D11/4
2008/0222778	A1	9/2008	Dierssen-Morice et al.		
2008/0250815	A1 *	10/2008	Wachler et al.	63/1.15
2011/0209268	A1	9/2011	Smitherman		
2012/0311768	A1	12/2012	Ladyzhenskaya et al.		
2014/0090149	A1	4/2014	Zuiderveen et al.		

OTHER PUBLICATIONS

Ever Socks Company, "Custom Logo Embroidered Socks," Retrieved from Internet on Aug. 20, 2014, URL: <<http://www.eversocks.com/monogram-series/133-custom-logo-embroidered-socks-444.html>>.

Rakuten Global Market, "Polo Ralph Lauren Socks," Retrieved from Internet on Aug. 19, 2014, URL: <<http://global.rakuten.com/en/store/otoku-shop/item/2018-023-900/?s-id=borderless>>.

Schmuck Fachshop, "Schmuck Kreuz," Retrieved from Internet on Aug. 19, 2014, URL: <<http://www.bigis-schatzkiste.de/schmuck-shop/Anhaenger/Kreuzanhaenger/Kreuzanhaenger-verschlungen>>.

Non-Final Office action for U.S. Appl. No. 29/494,539 mailed Jan. 21, 2015.

* cited by examiner

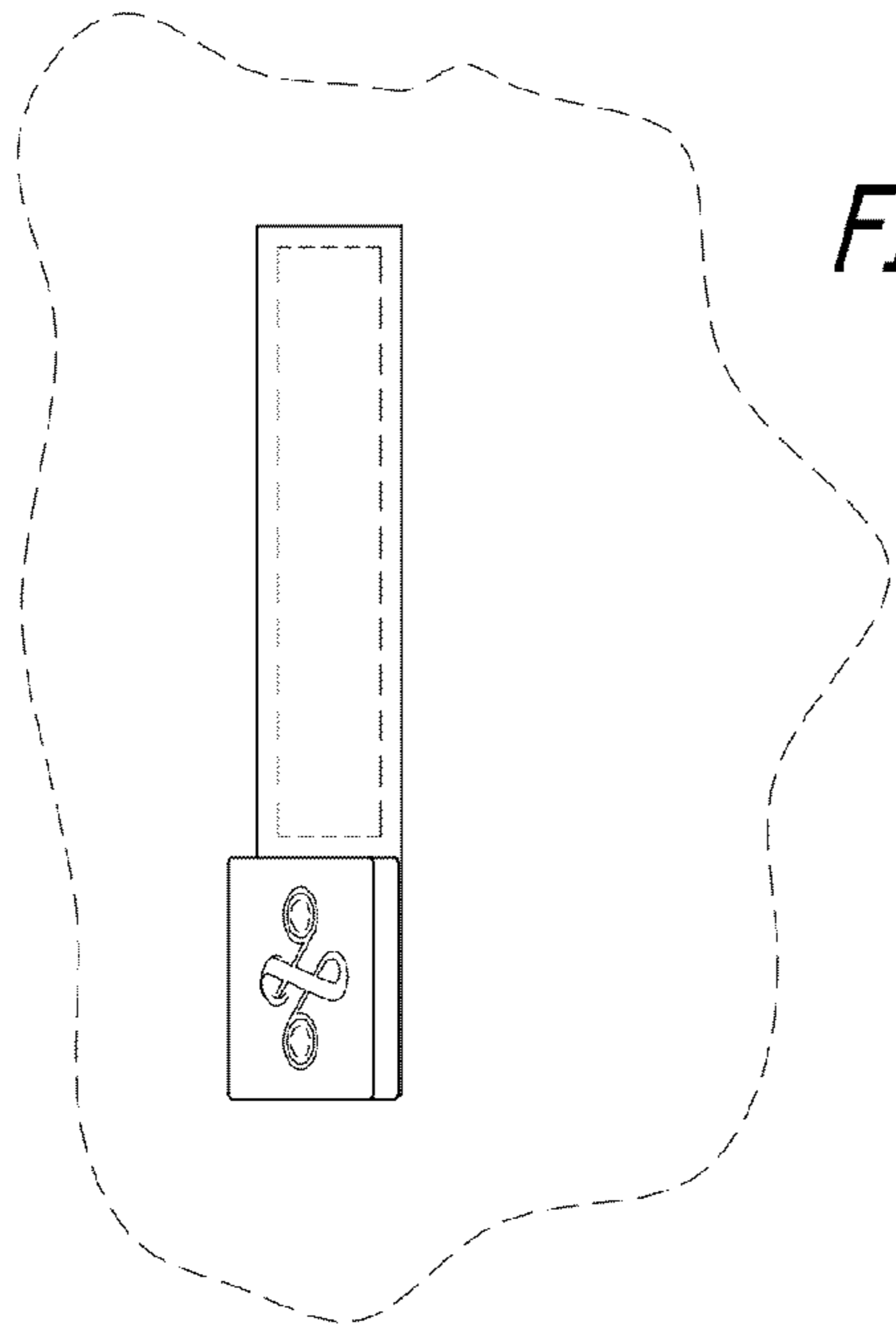

FIG. 1

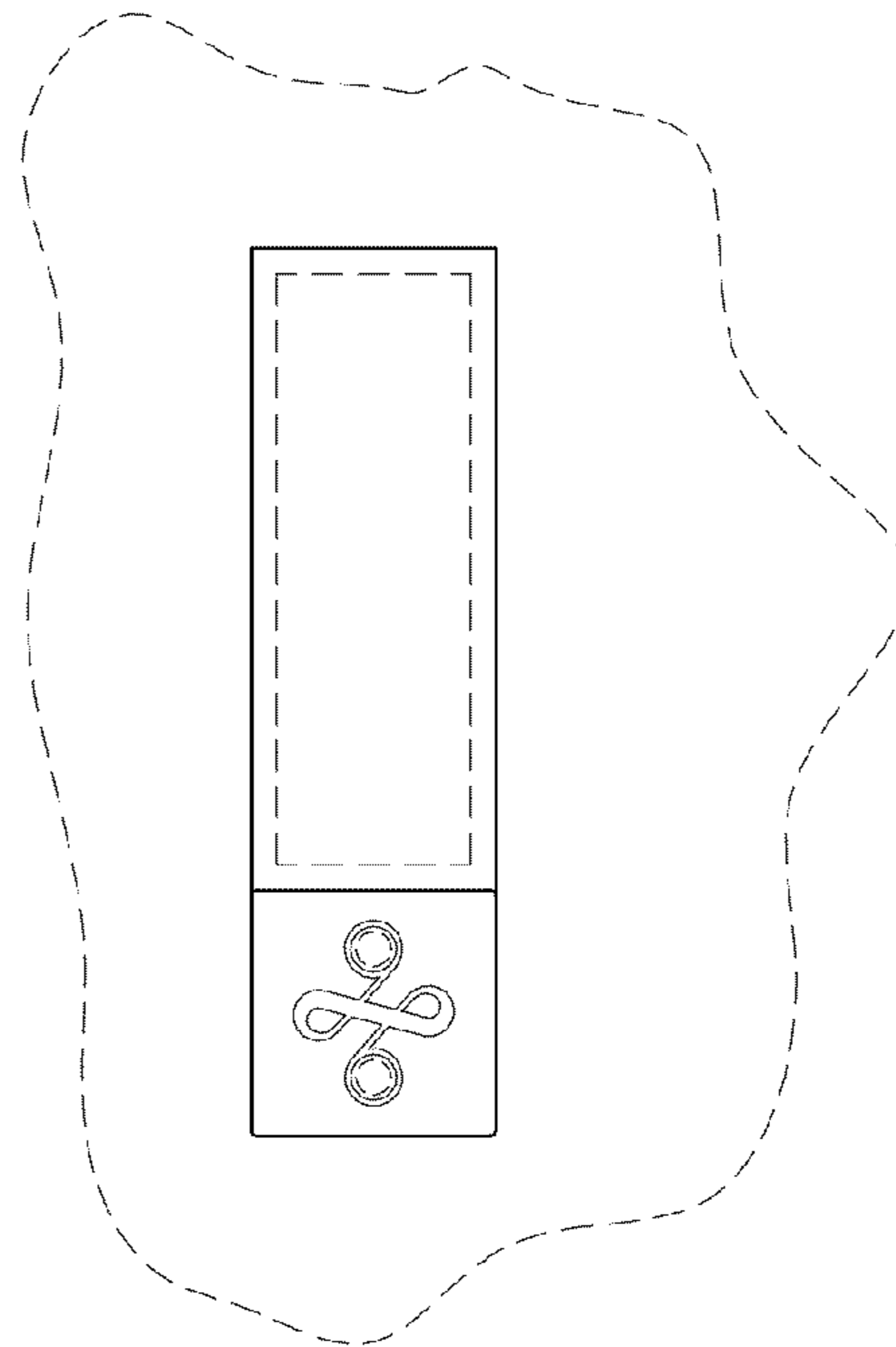

FIG. 2

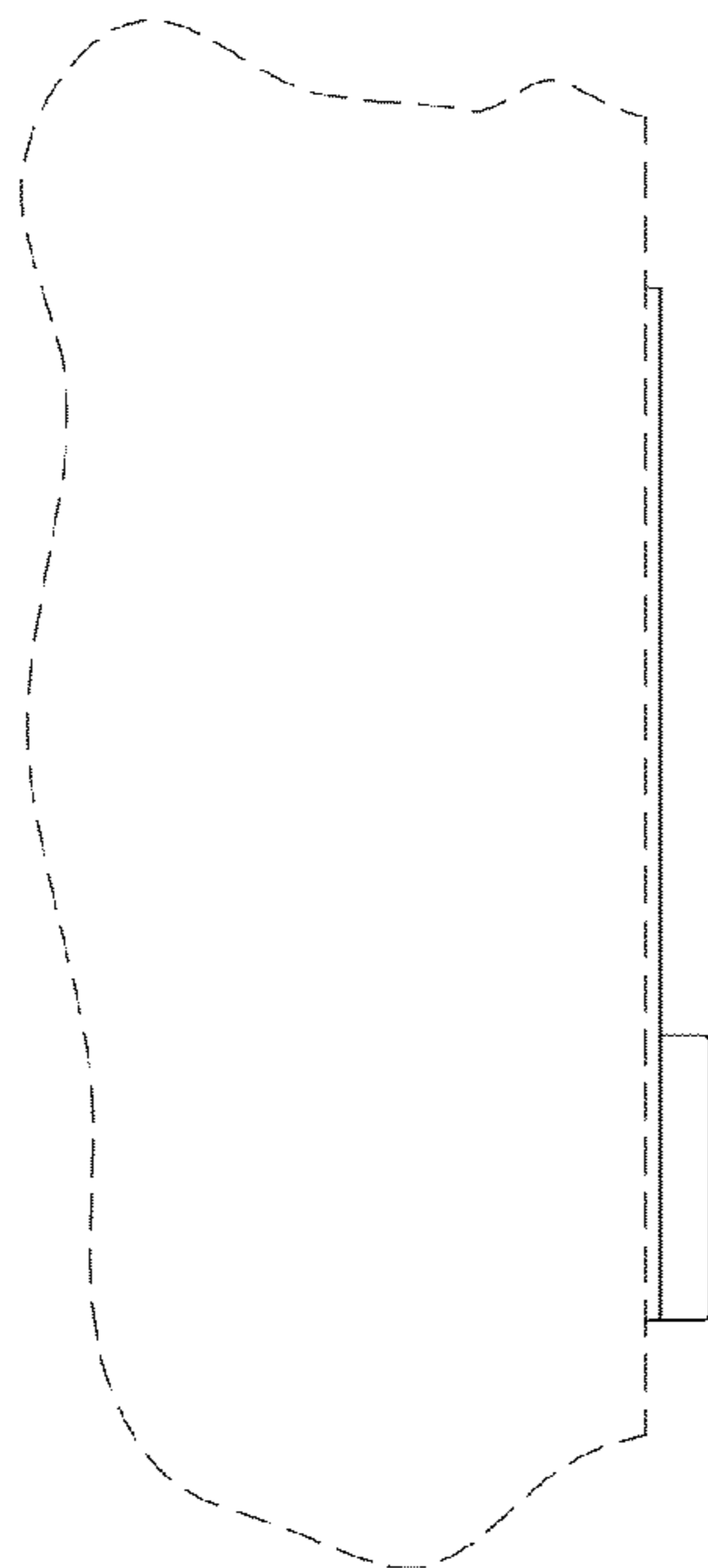

FIG. 3

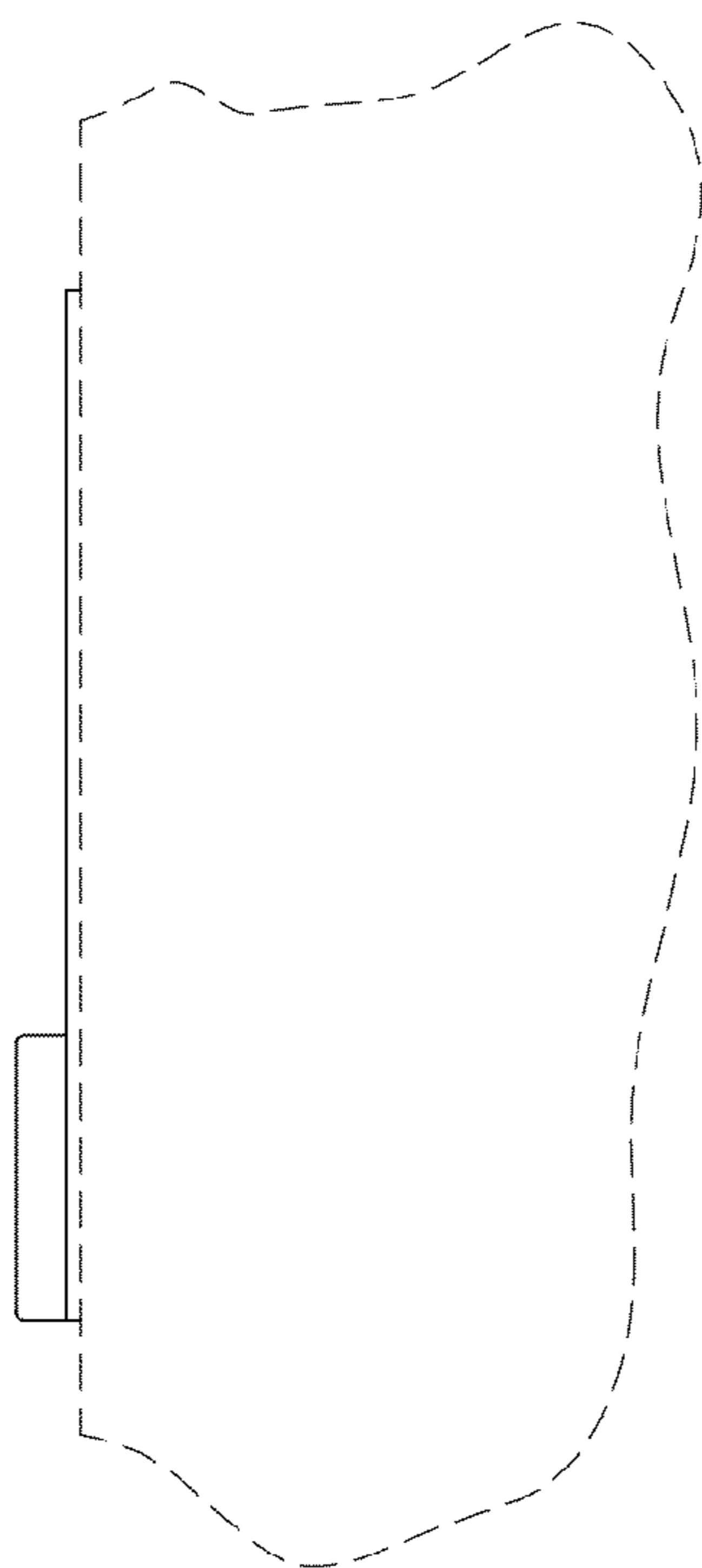

FIG. 4

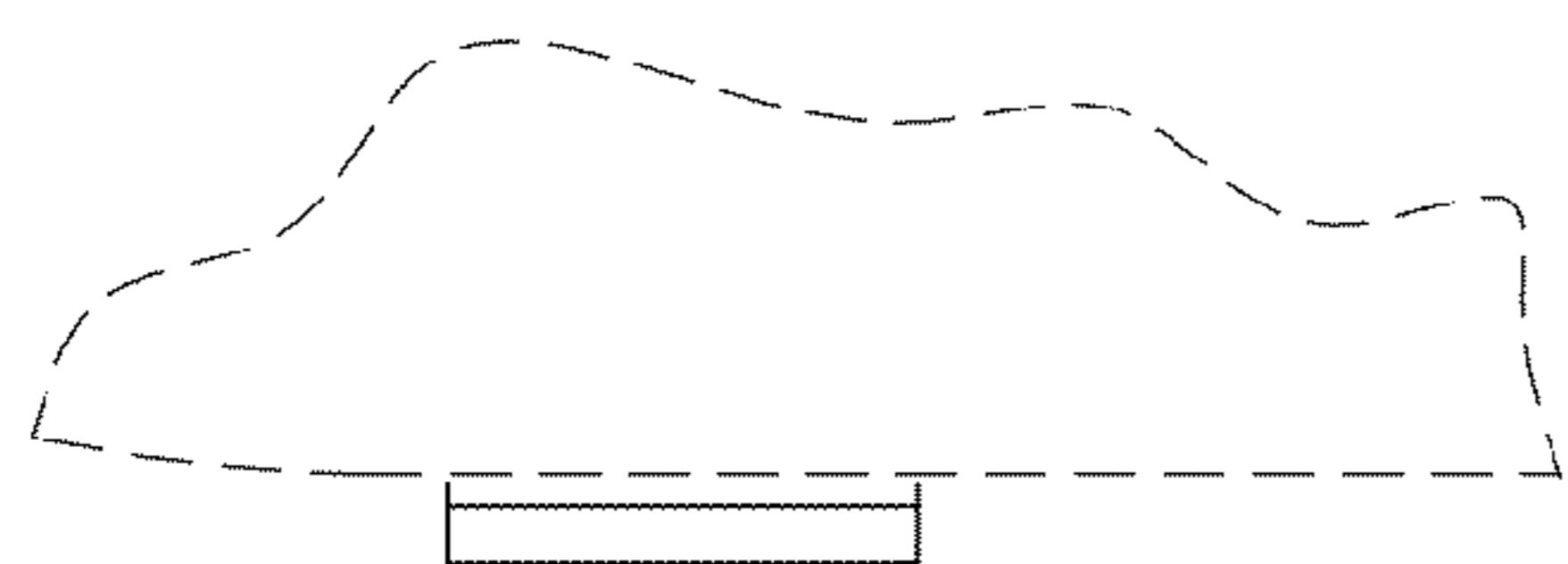
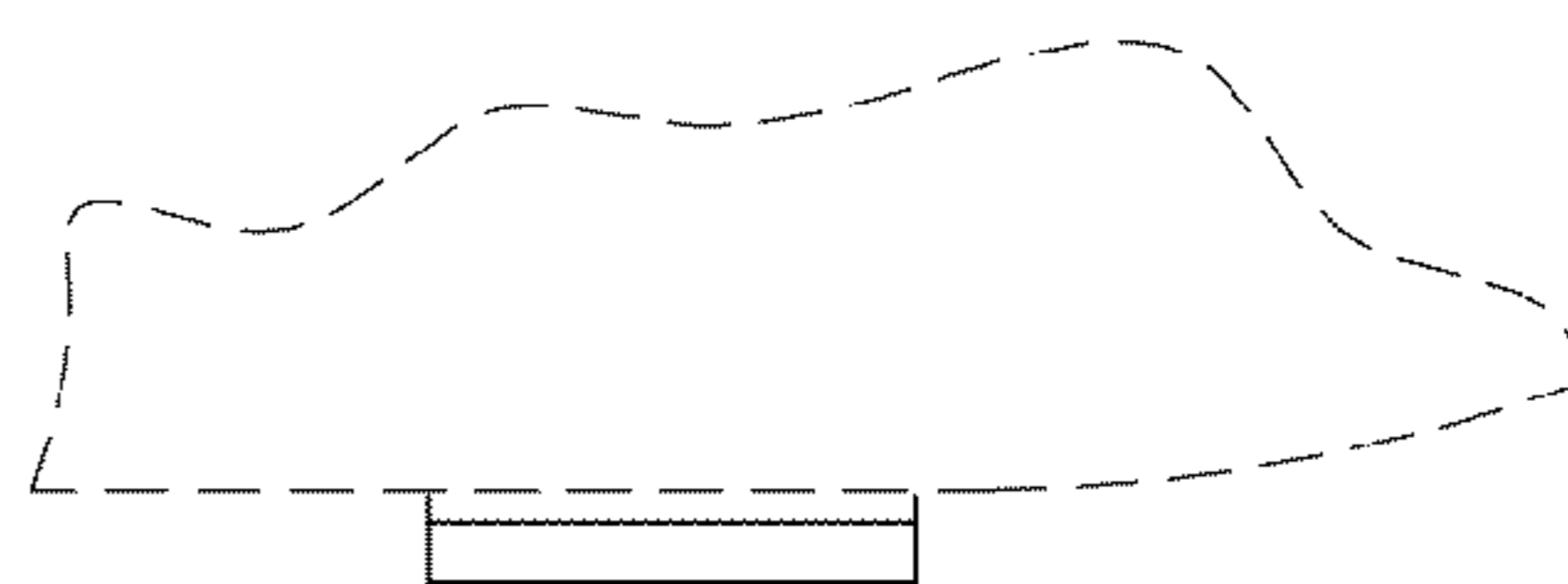

FIG. 5

FIG. 6



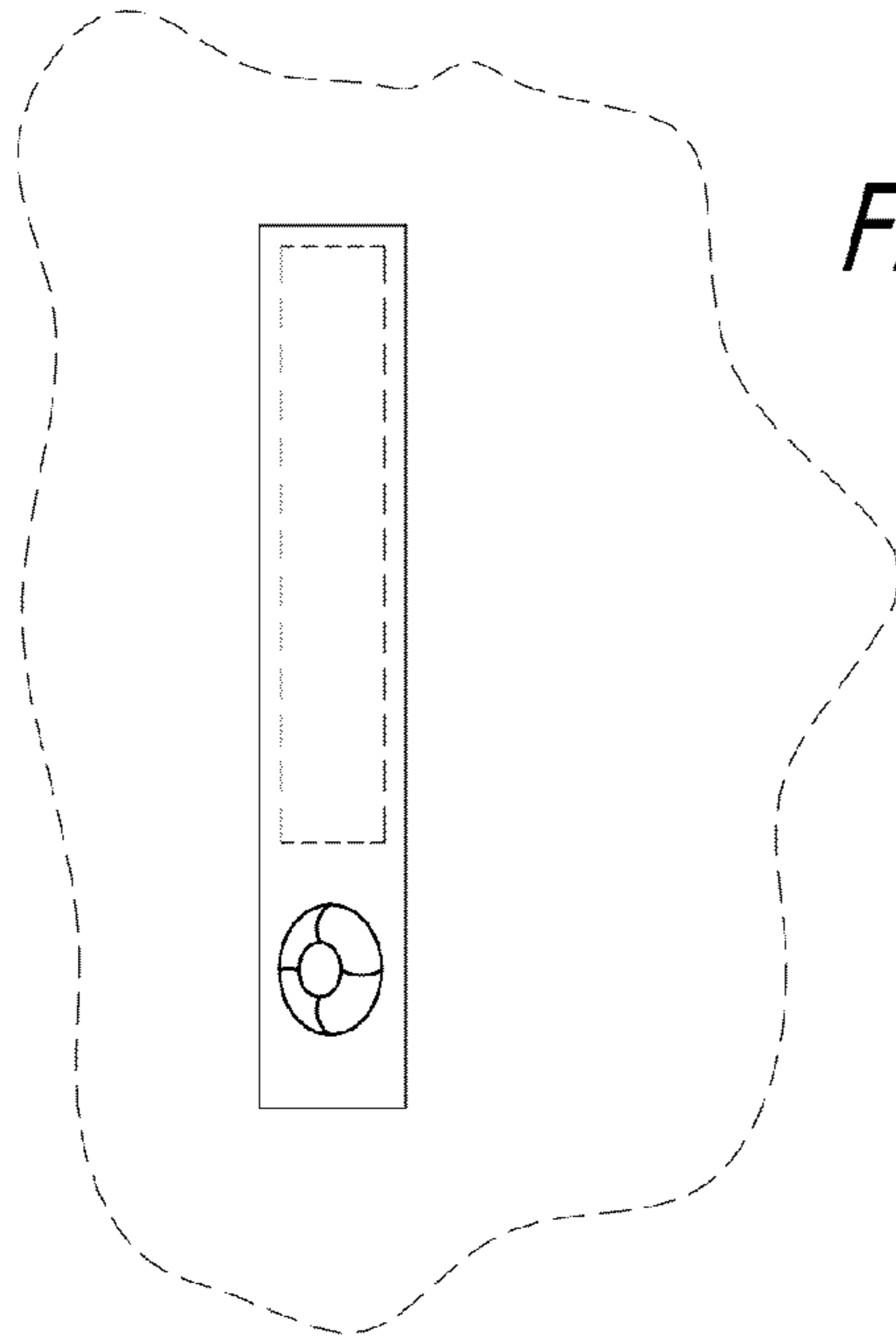

FIG. 7

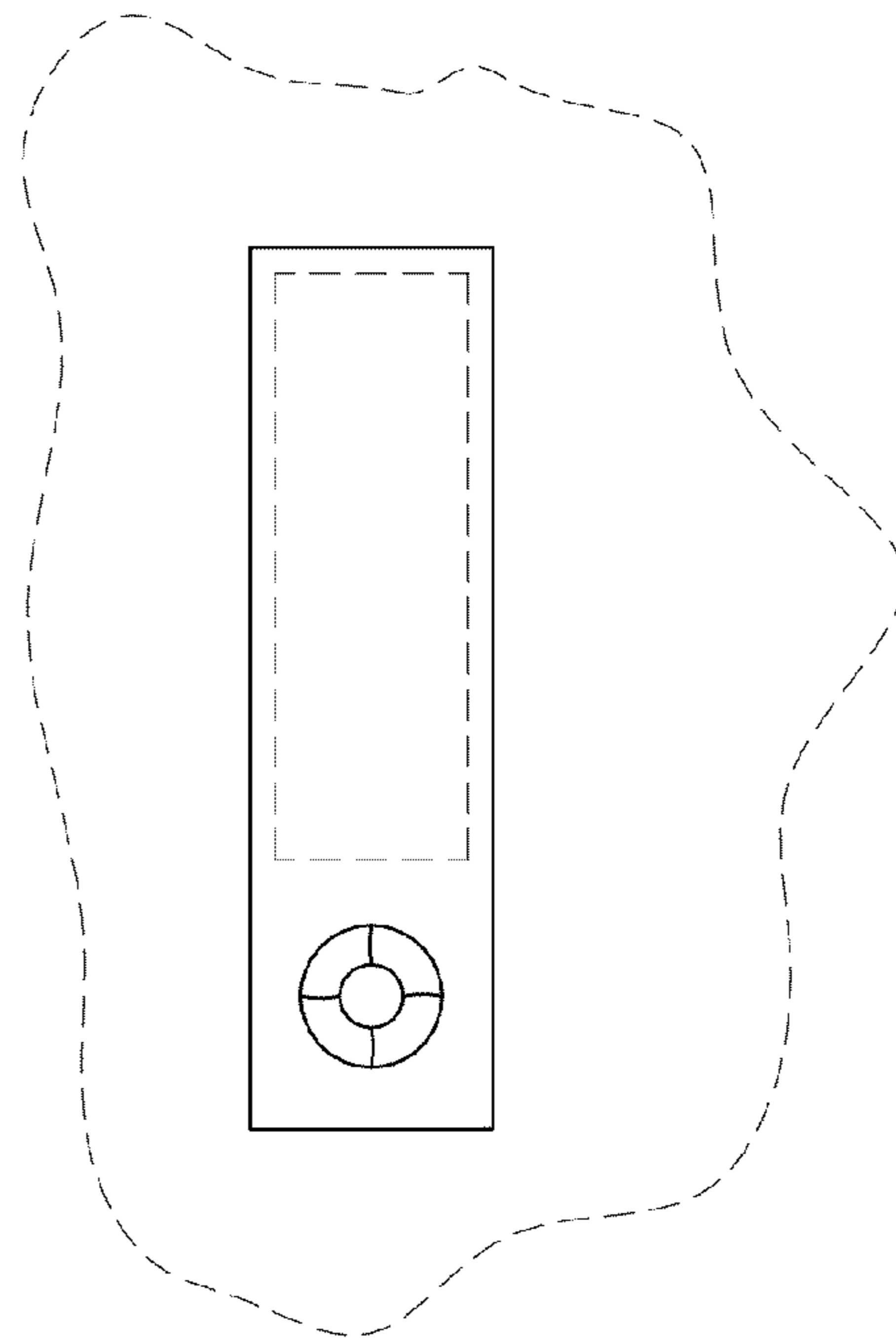

FIG. 8

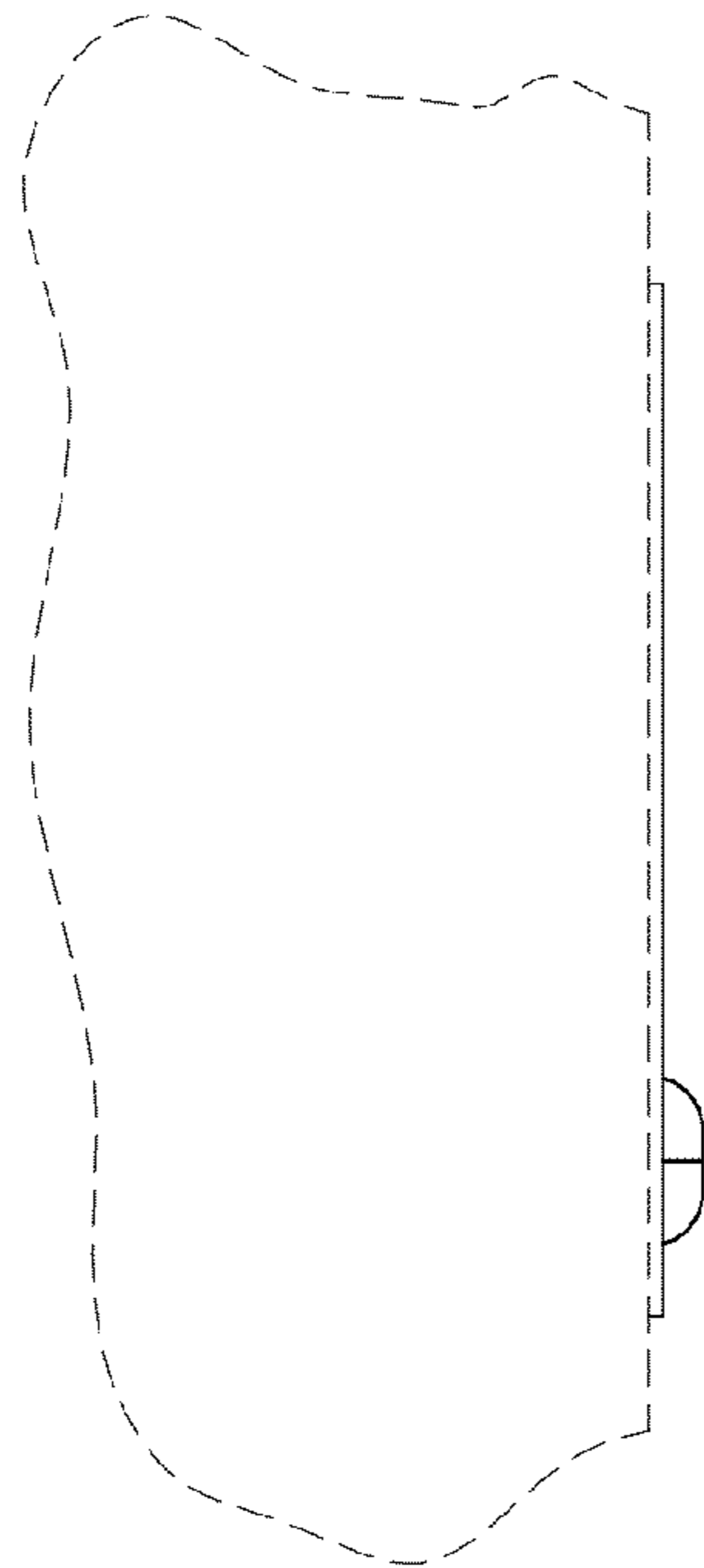

FIG. 9

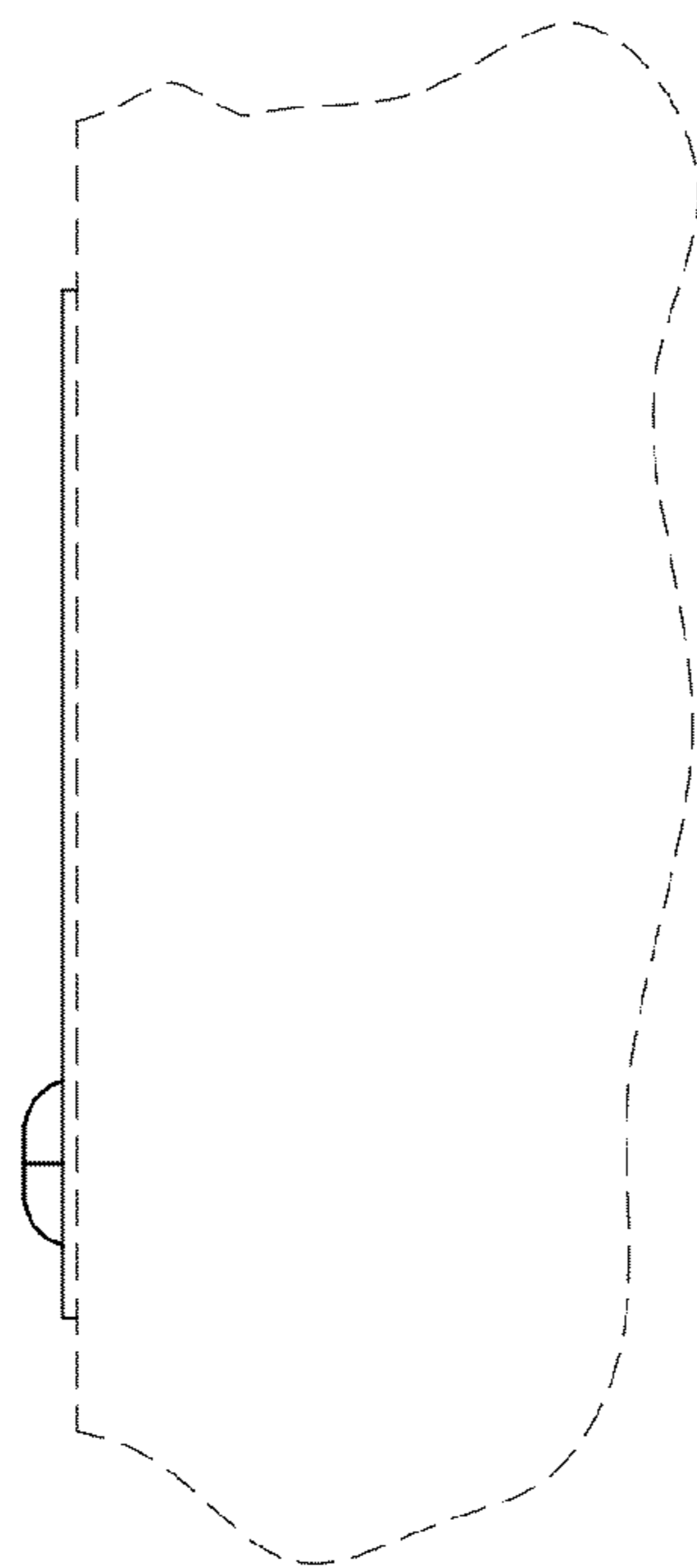

FIG. 10

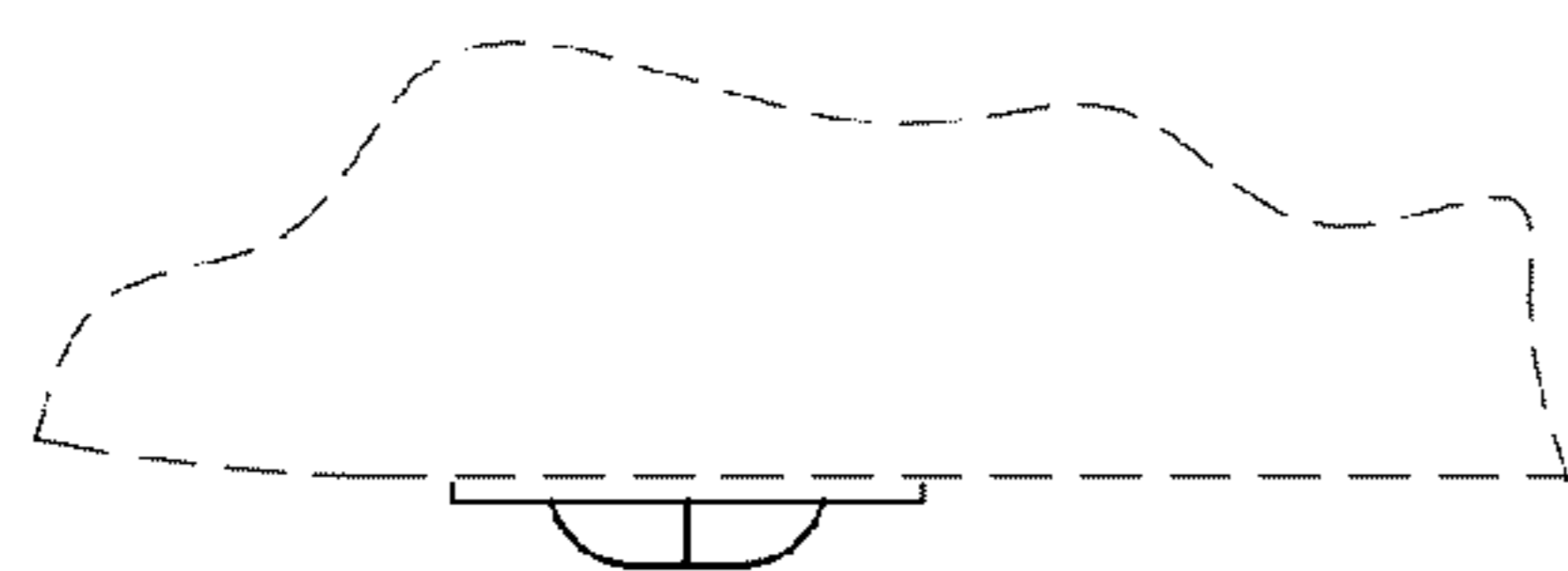
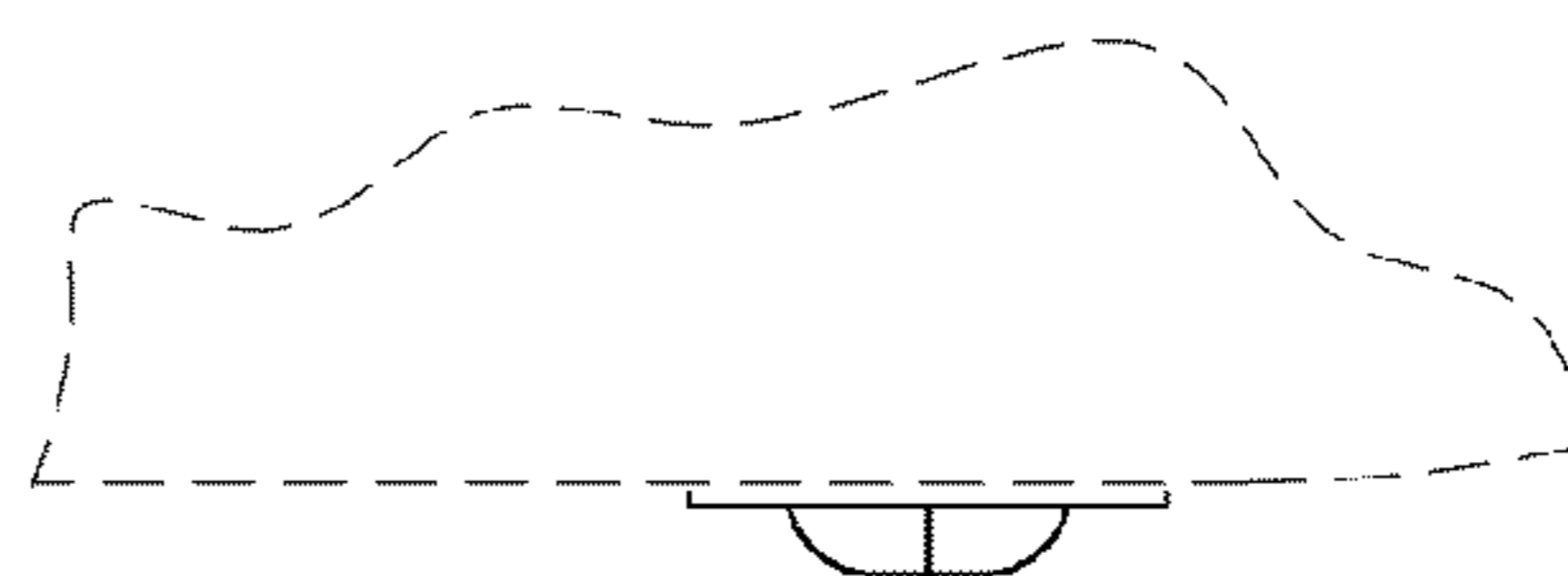

FIG. 11

FIG. 12



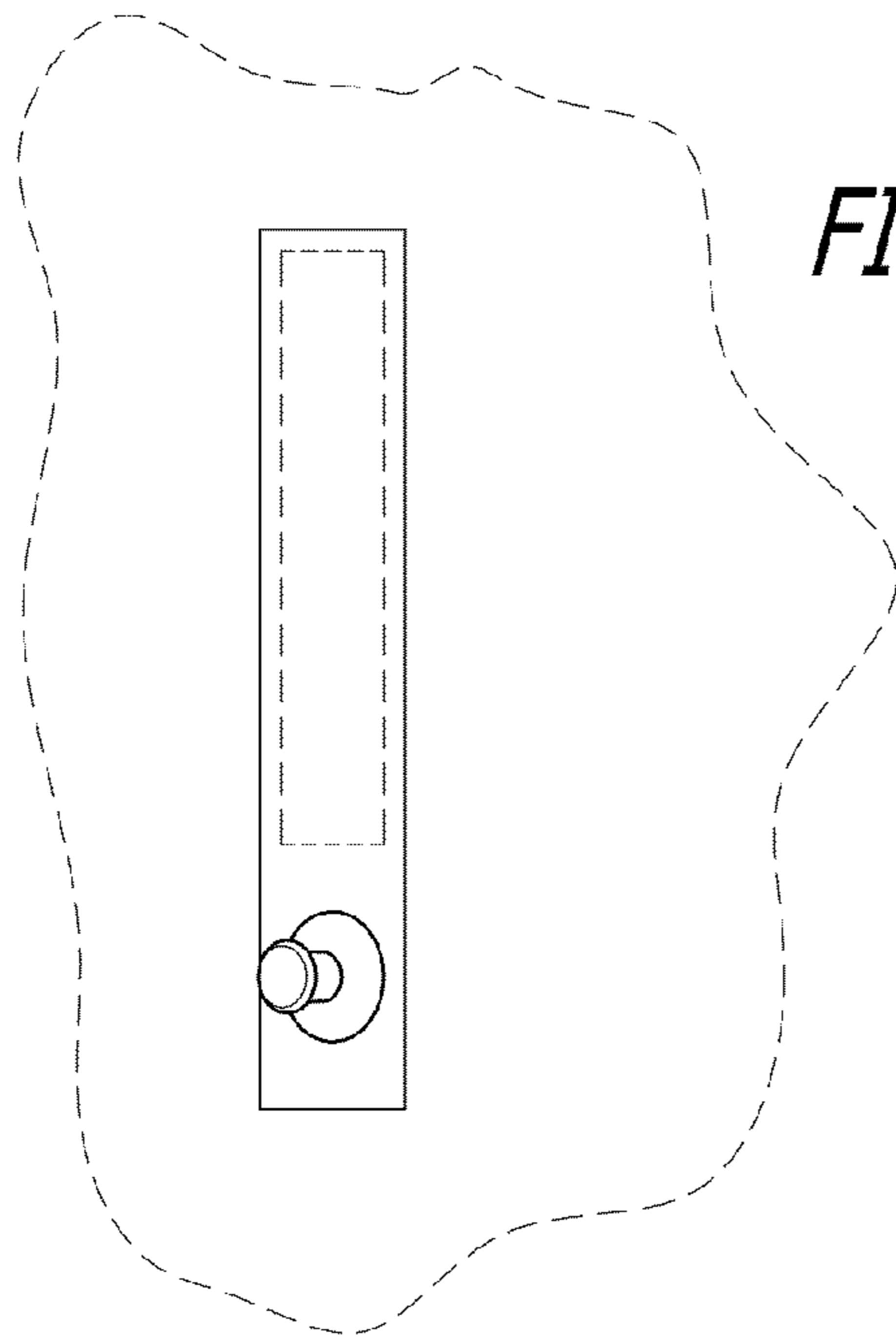

FIG. 13

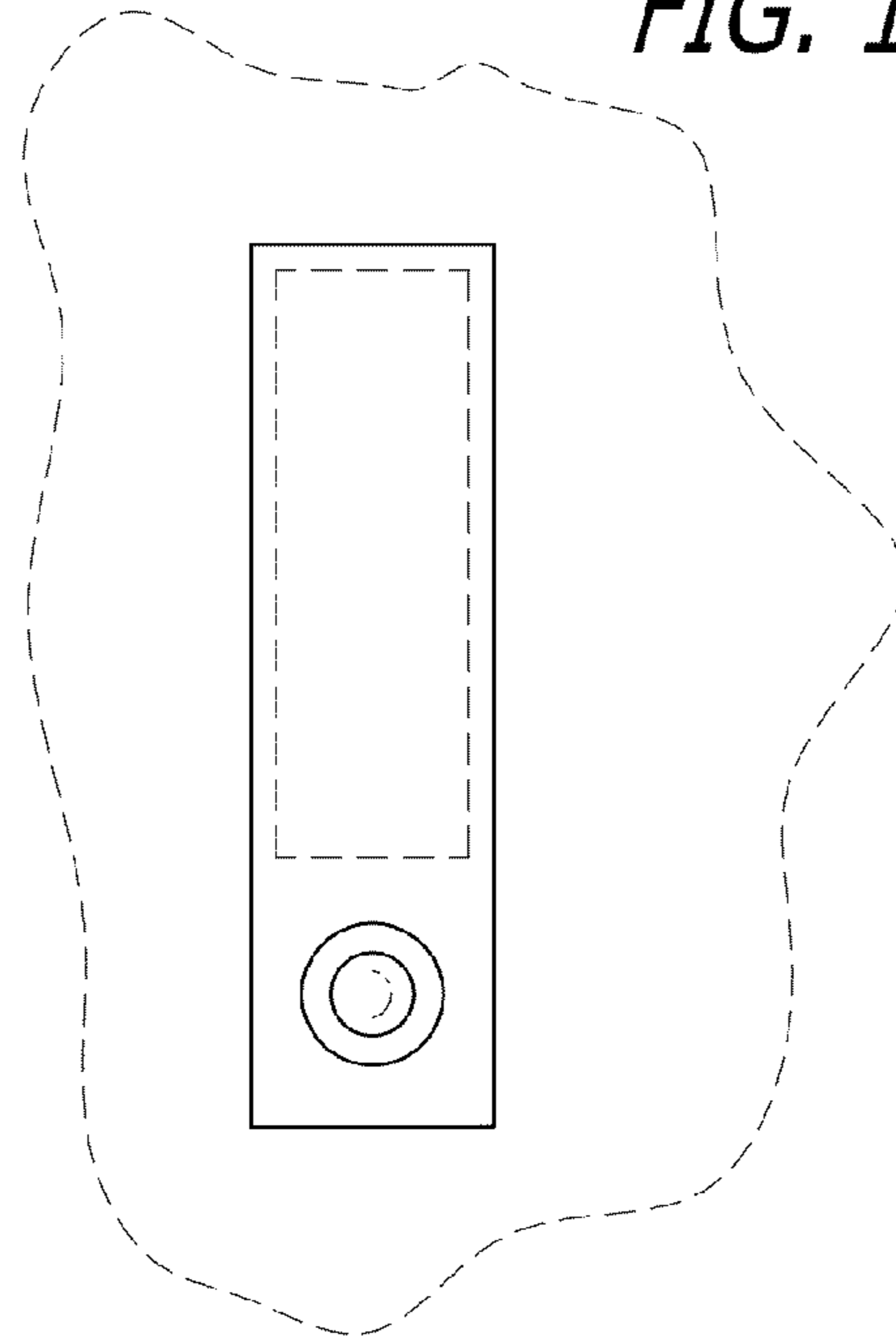

FIG. 14

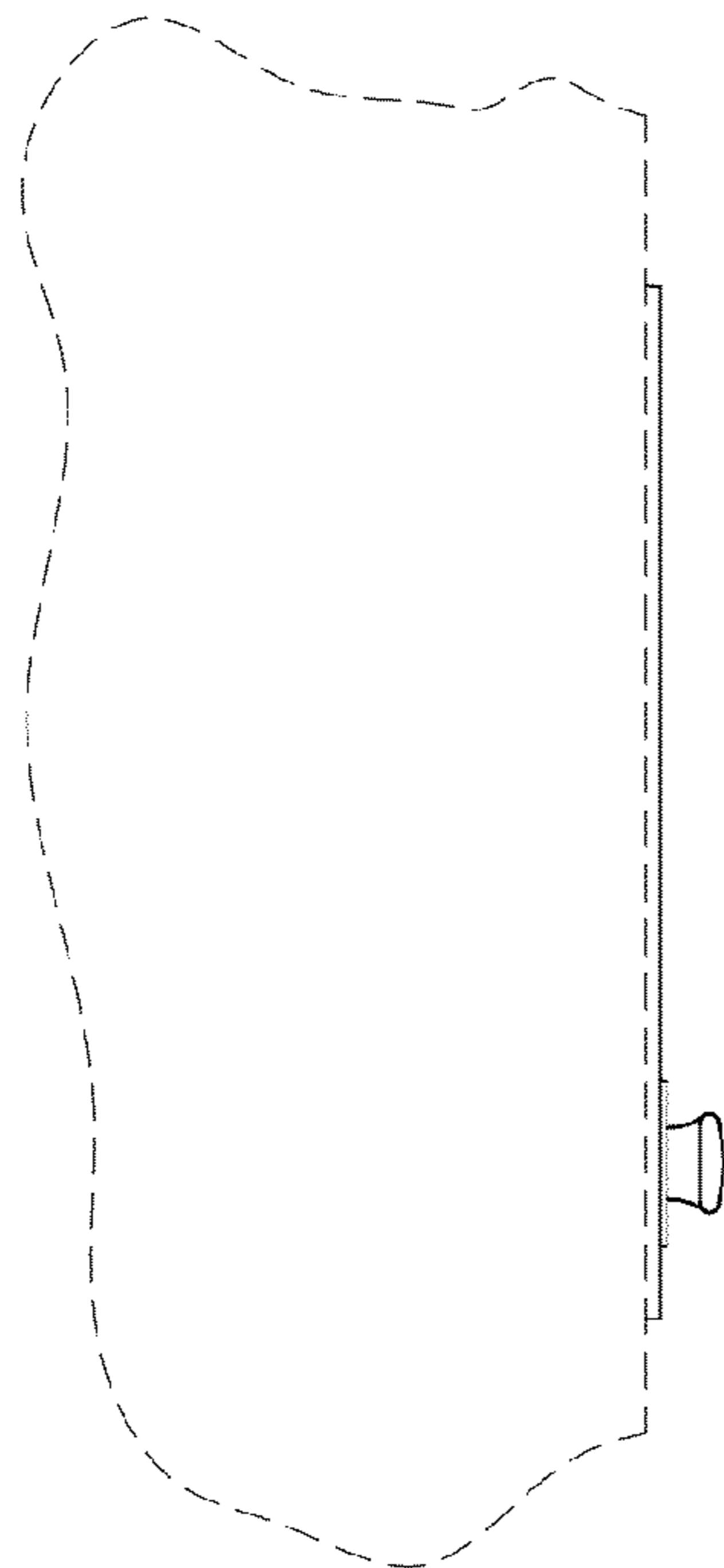

FIG. 15

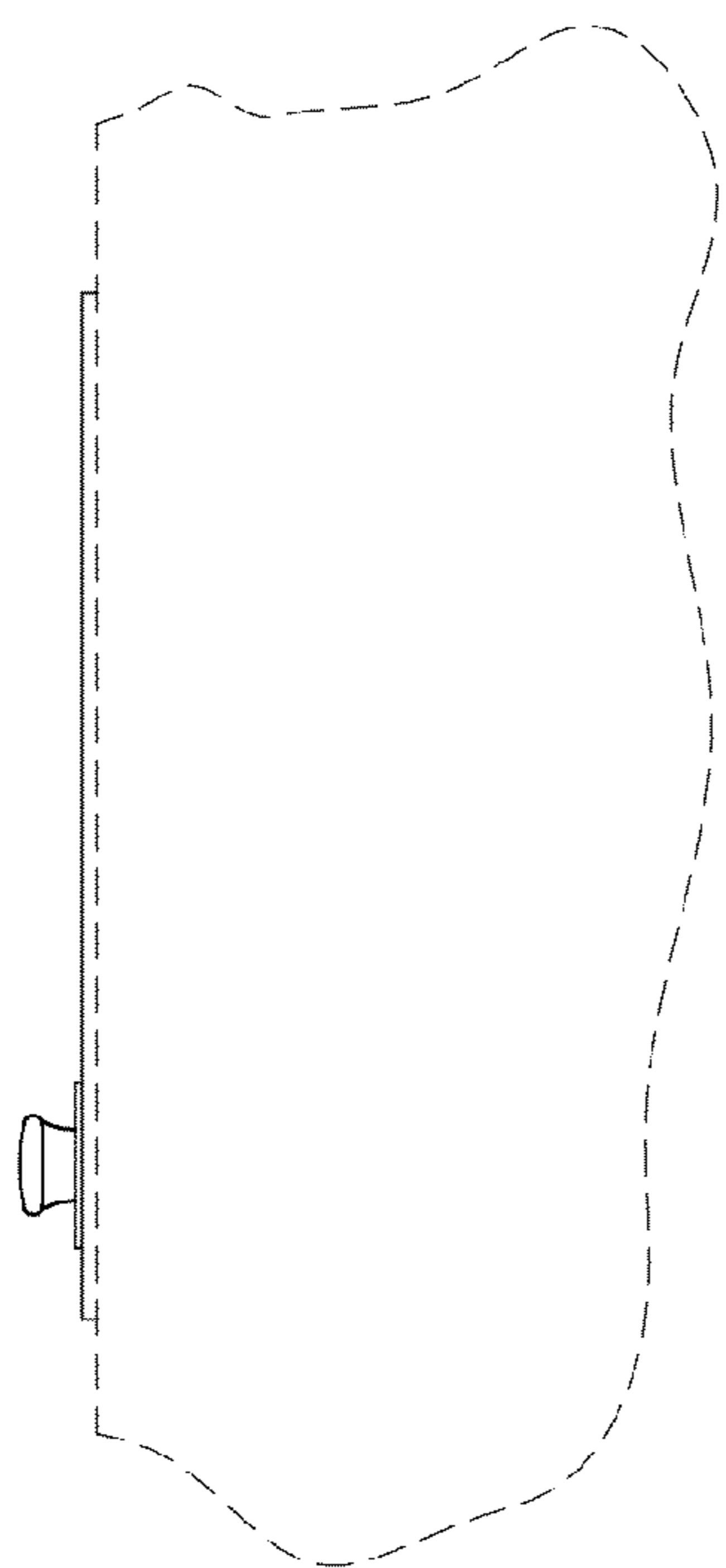

FIG. 16

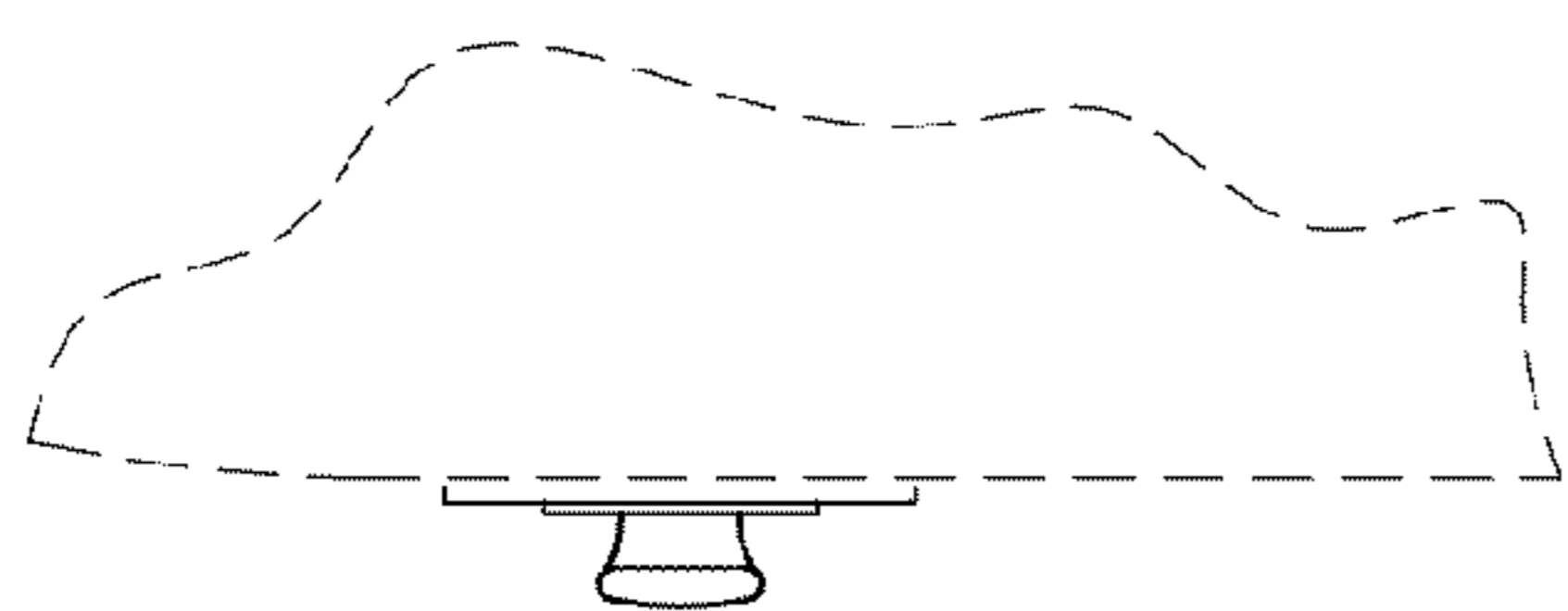

FIG. 17

FIG. 18

