

US00D736094S

(12) **United States Design Patent**
Jeong

(10) **Patent No.:** **US D736,094 S**
(45) **Date of Patent:** **** Aug. 11, 2015**

- (54) **CONTAINER FOR COSMETICS**
- (71) Applicant: **LG HOUSEHOLD & HEALTH CARE LTD.**, Seoul (KR)
- (72) Inventor: **Song Eun Jeong**, Seoul (KR)
- (73) Assignee: **LG HOUSEHOLD & HEALTH CARE LTD.**, Seoul (KR)
- (**) Term: **14 Years**
- (21) Appl. No.: **29/512,441**
- (22) Filed: **Dec. 18, 2014**
- (30) **Foreign Application Priority Data**
Nov. 27, 2014 (KR) 30-2014-0057436
- (51) **LOC (10) Cl.** **09-01**
- (52) **U.S. Cl.**
USPC **D9/682**
- (58) **Field of Classification Search**
USPC D9/682-694, 719, 516, 517, 520, 526,
D9/529, 544, 545, 549-558, 563-568, 435,
D9/436, 444, 445, 447-449, 441, 451, 655,
D9/661, 664, 667; D6/542; D28/76-91.1
CPC B65D 83/14; B65D 83/16; B65D 83/20;
B65D 83/22; B65D 83/222; B65D 83/38;
B65D 83/40; B65D 1/0223; B65D 2501/0081;
B05B 11/00; B05B 11/0037; B05B 11/3001;
B05B 11/3042; B05B 11/3043; B05B
11/3045; B05B 11/3047; B05B 11/3052;
B05B 11/3059; B05B 11/306; A45D
2034/007; A45D 34/00
See application file for complete search history.

- (56) **References Cited**
U.S. PATENT DOCUMENTS
D117,140 S * 10/1939 Gaige D28/82
D153,793 S * 5/1949 Hageman et al. D9/669

- D196,613 S * 10/1963 Platte D9/558
- D208,825 S * 10/1967 Hutton D9/686
- D338,828 S * 8/1993 Segati D9/694
- D378,665 S * 4/1997 Fenton et al. D9/558
- D382,487 S * 8/1997 Tippitt et al. D9/555
- D404,293 S * 1/1999 Bertolini et al. D9/693
- D425,432 S * 5/2000 Lewin D9/558
- D444,389 S * 7/2001 Bakic D9/539
- D449,229 S * 10/2001 Mohary et al. D9/558
- D449,230 S * 10/2001 Harris et al. D9/558
- D468,214 S * 1/2003 Kuzma et al. D9/558
- 7,134,577 B1 * 11/2006 Verma 222/321.9
- D618,557 S * 6/2010 Jin et al. D9/655
- D680,442 S * 4/2013 Park et al. D9/682
- D681,475 S * 5/2013 Park D9/682
- D683,236 S * 5/2013 Park et al. D9/682
- D687,716 S * 8/2013 Lee D9/682
- D690,204 S * 9/2013 Crawford et al. D9/565
- D694,121 S * 11/2013 Park D9/682
- 2005/0072808 A1 * 4/2005 Kitamura 222/309
- 2010/0006606 A1 * 1/2010 Lee 222/383.1
- 2014/0331416 A1 * 11/2014 Akinbobola et al. 8/405

* cited by examiner

Primary Examiner — Catherine Tuttle

(57) **CLAIM**
The ornamental design for a container for cosmetics, as shown and described.

DESCRIPTION

FIG. 1 is a perspective view of a container for cosmetics showing my new design;
 FIG. 2 is a front elevational view thereof, the rear view being a mirror image;
 FIG. 3 is a left side elevational view thereof;
 FIG. 4 is a right side elevational view thereof;
 FIG. 5 is a top plan view thereof;
 FIG. 6 is a bottom plan view thereof;
 FIG. 7 is an exploded view thereof; and,
 FIG. 8 is an enlarged detailed view of the exploded view of FIG. 7 as shown in circle 8 in FIG. 7.
 The container for cosmetics is made of a synthetic resin.

1 Claim, 8 Drawing Sheets

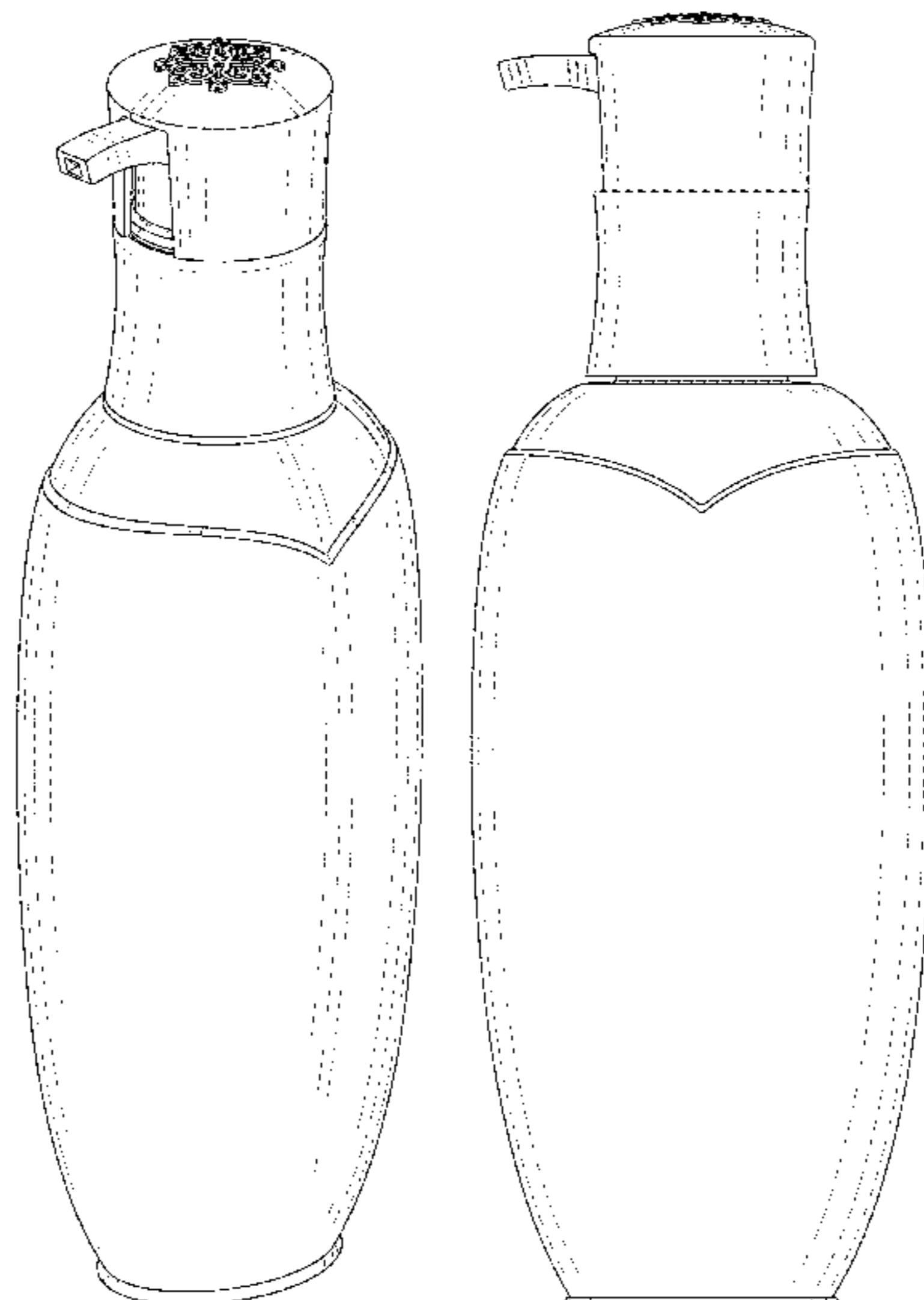

FIG. 1

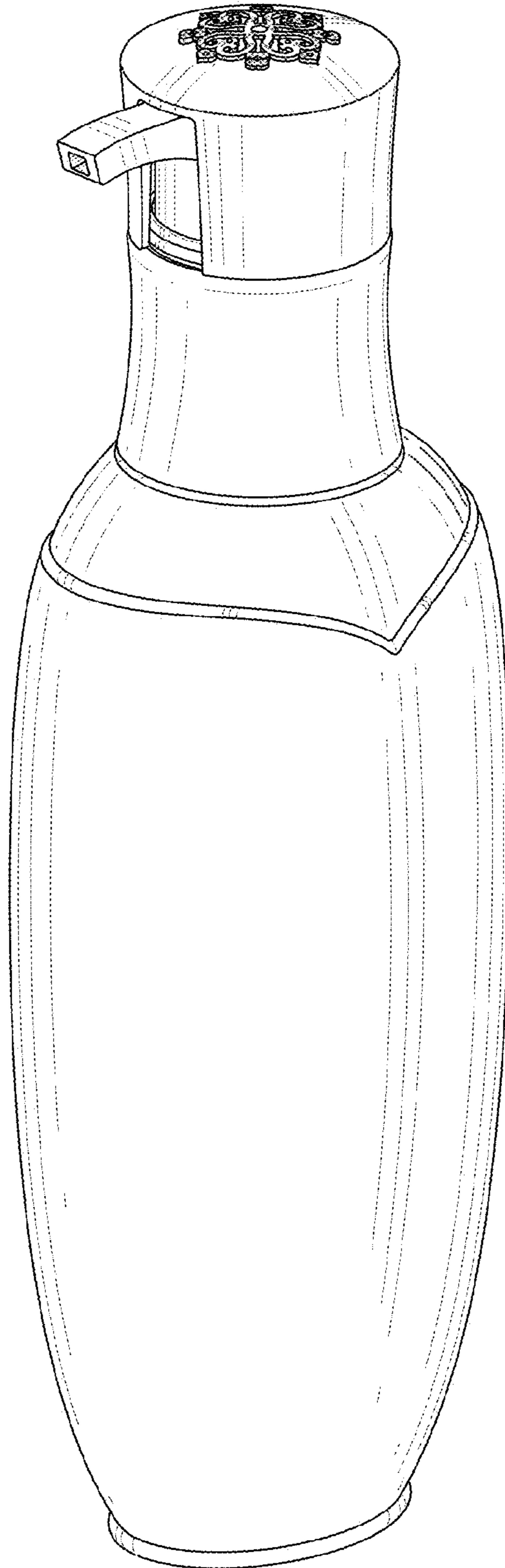

FIG. 2

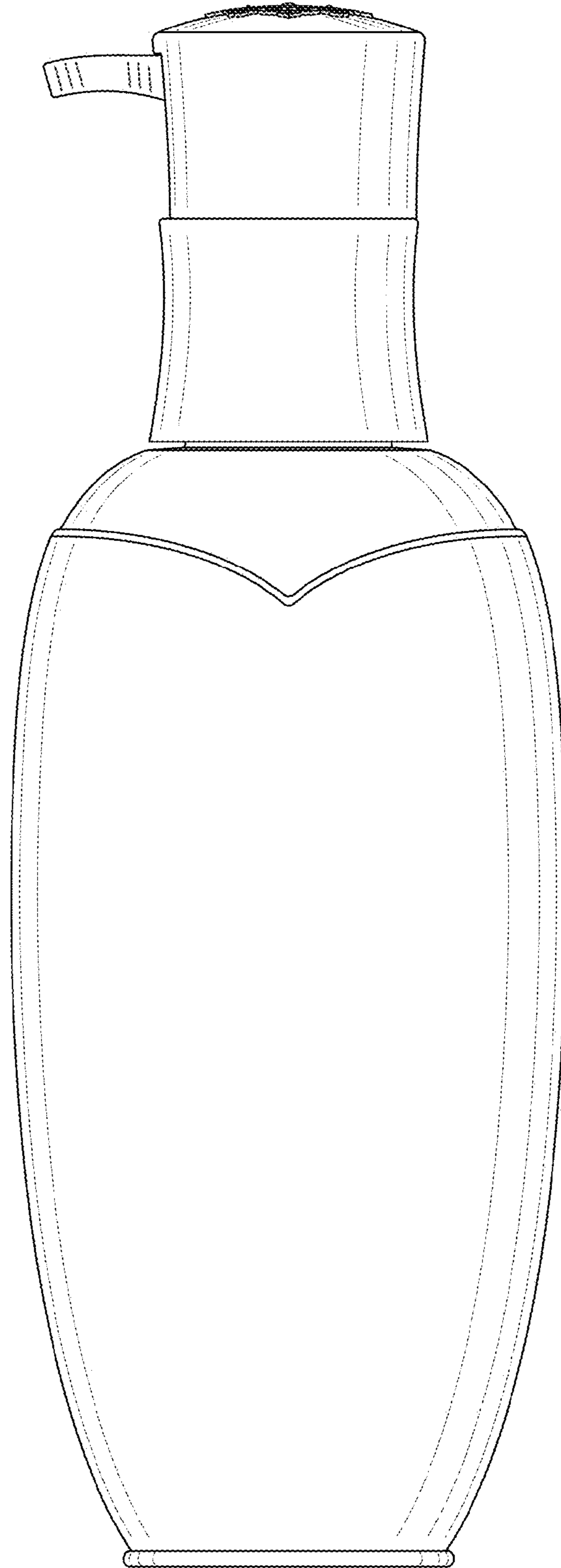

FIG. 3

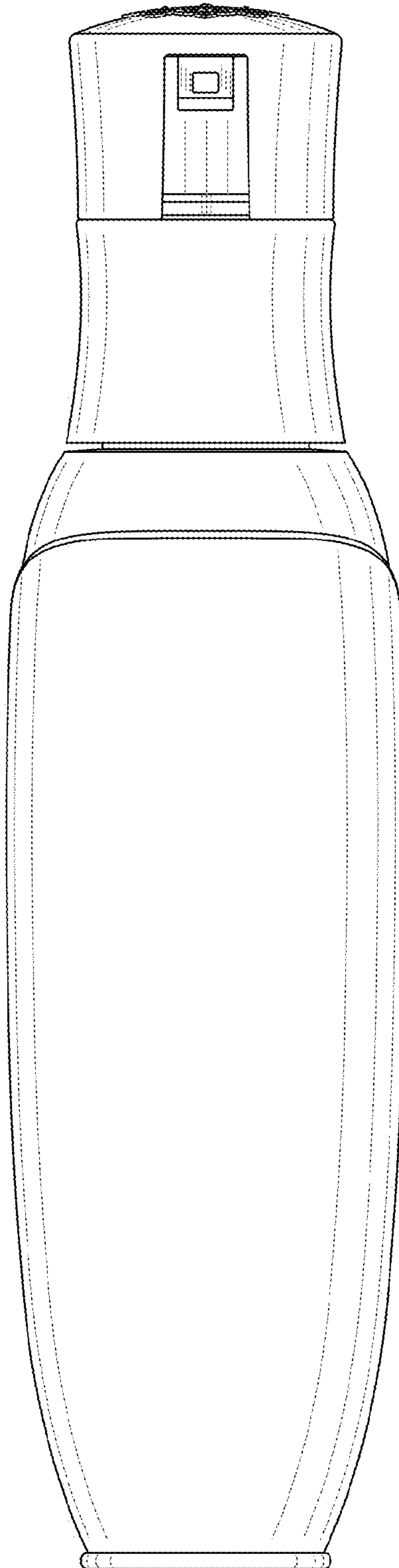

FIG. 4

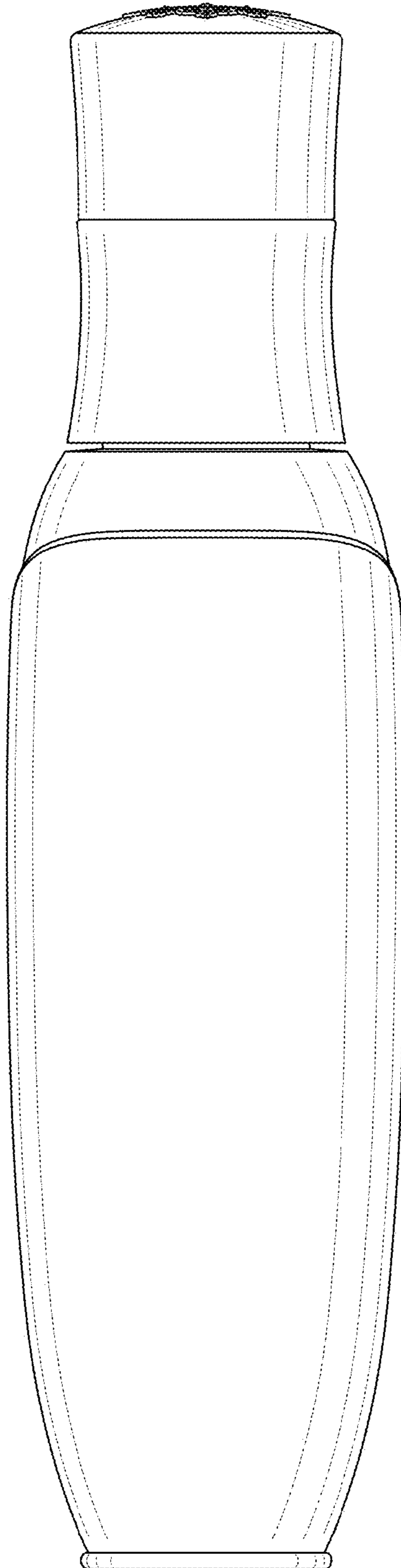

FIG. 5

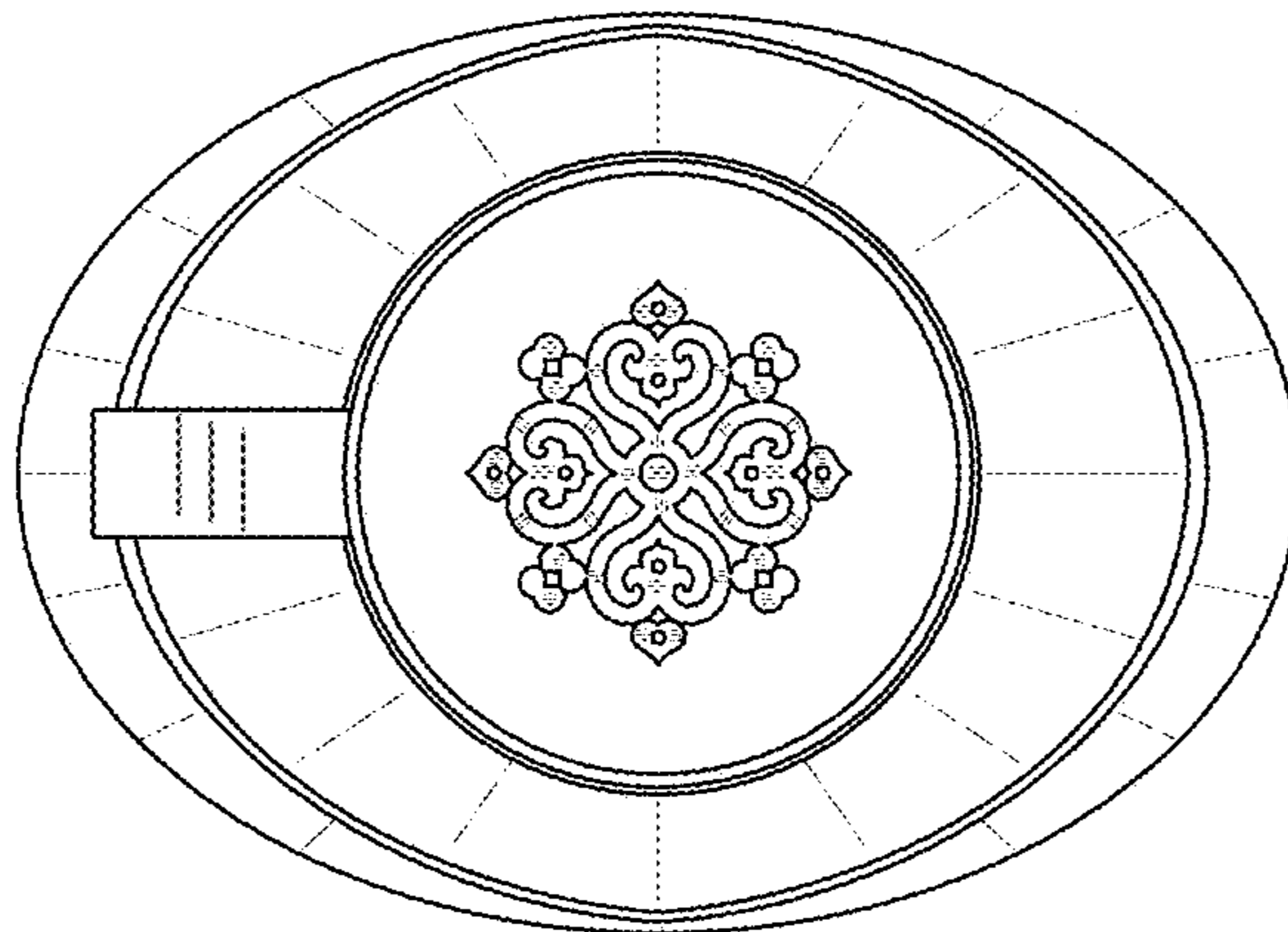

FIG. 6

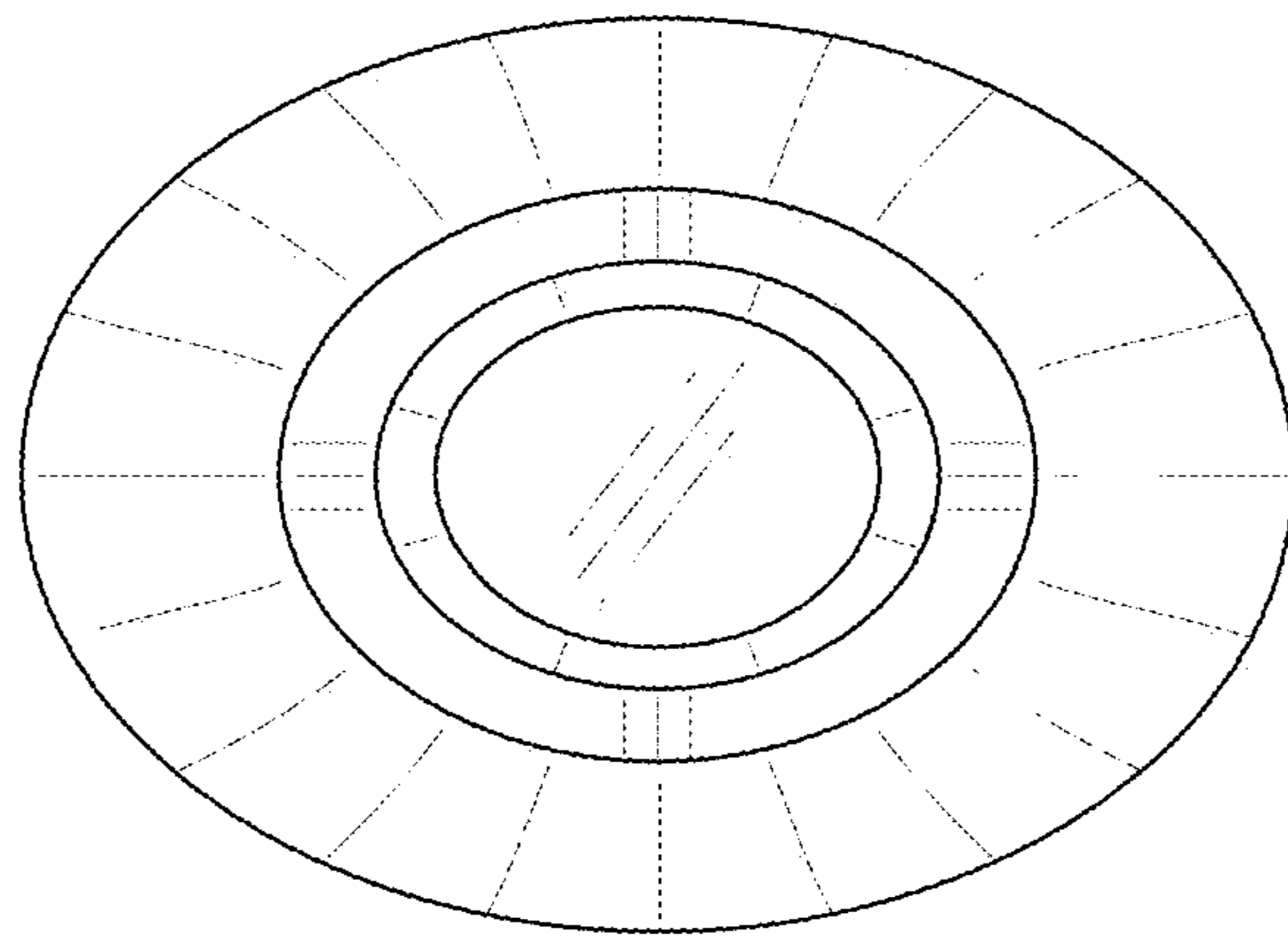

FIG. 7



FIG. 8

