

US00D736075S

(12) **United States Design Patent**
Forbes et al.

(10) **Patent No.:** **US D736,075 S**

(45) **Date of Patent:** **** Aug. 11, 2015**

(54) **ORNAMENT ATTACHMENT CLIP**

(71) Applicant: **TARGET BRANDS, INC.**,
Minneapolis, MN (US)

(72) Inventors: **Kathryn D. Forbes**, Minnetonka, MN
(US); **Monica R. Rush**, Minneapolis,
MN (US)

(73) Assignee: **TARGET BRANDS, INC.**,
Minneapolis, MN (US)

(**) Term: **14 Years**

(21) Appl. No.: **29/460,102**

(22) Filed: **Jul. 8, 2013**

(51) **LOC (10) Cl.** **08-05**

(52) **U.S. Cl.**
USPC **D8/396**

(58) **Field of Classification Search**
USPC D8/394, 396
CPC A45D 8/12; A45D 8/04; A45D 8/20;
A45D 8/00

See application file for complete search history.

(56) **References Cited**

U.S. PATENT DOCUMENTS

2,053,139	A	9/1936	Donovan et al.	
2,063,924	A	12/1936	Hanko	
2,521,394	A	9/1950	Minners	
2,599,303	A	6/1952	Ward	
3,386,070	A	5/1968	Jansson et al.	
5,975,092	A *	11/1999	Tsai	132/275
5,988,184	A *	11/1999	Shu	132/277
7,175,145	B2	2/2007	Simpson	
7,419,277	B2	9/2008	Von Ronn et al.	
7,419,283	B2	9/2008	Von Ronn et al.	
7,717,388	B2	5/2010	Rizzo	
7,992,579	B2 *	8/2011	Longoria et al.	132/279
8,109,279	B2 *	2/2012	Chudzik et al.	132/277

(Continued)

OTHER PUBLICATIONS

Office Action from Canadian Patent Application No. 153,489, mailed Aug. 14, 2014 (2 pages).

(Continued)

Primary Examiner — Holly Baynham

(74) *Attorney, Agent, or Firm* — Griffiths & Seaton PLLC;
JoAnn M. Seaton

(57) **CLAIM**

The ornamental design for an ornament attachment clip, as shown and described.

DESCRIPTION

FIG. 1 is a front, perspective view of an ornament attachment clip showing our new design in a closed position;

FIG. 2 is a front view thereof;

FIG. 3 is a rear view thereof;

FIG. 4 is a right side view thereof;

FIG. 5 is a left side view thereof;

FIG. 6 is a top view thereof; and

FIG. 7 is a bottom view thereof.

FIG. 8 is a front, perspective view of the ornament attachment clip of FIG. 1 with additional environmental subject matter illustrated in broken lines.

FIG. 9 is a front, perspective view of the ornament attachment clip of FIG. 1 in an open position;

FIG. 10 is a front view thereof;

FIG. 11 is a rear view thereof;

FIG. 12 is a right side view thereof;

FIG. 13 is a left side view thereof;

FIG. 14 is a top view thereof; and,

FIG. 15 is a bottom view thereof.

The features shown in broken lines are portions of the ornament attachment clip or environmental subject matter to the ornament attachment clip forming no part of the claimed design. The features shown in long dash-short dash bolded broken lines indicate the bounds of the claimed design and otherwise form no part of the claimed design.

1 Claim, 15 Drawing Sheets

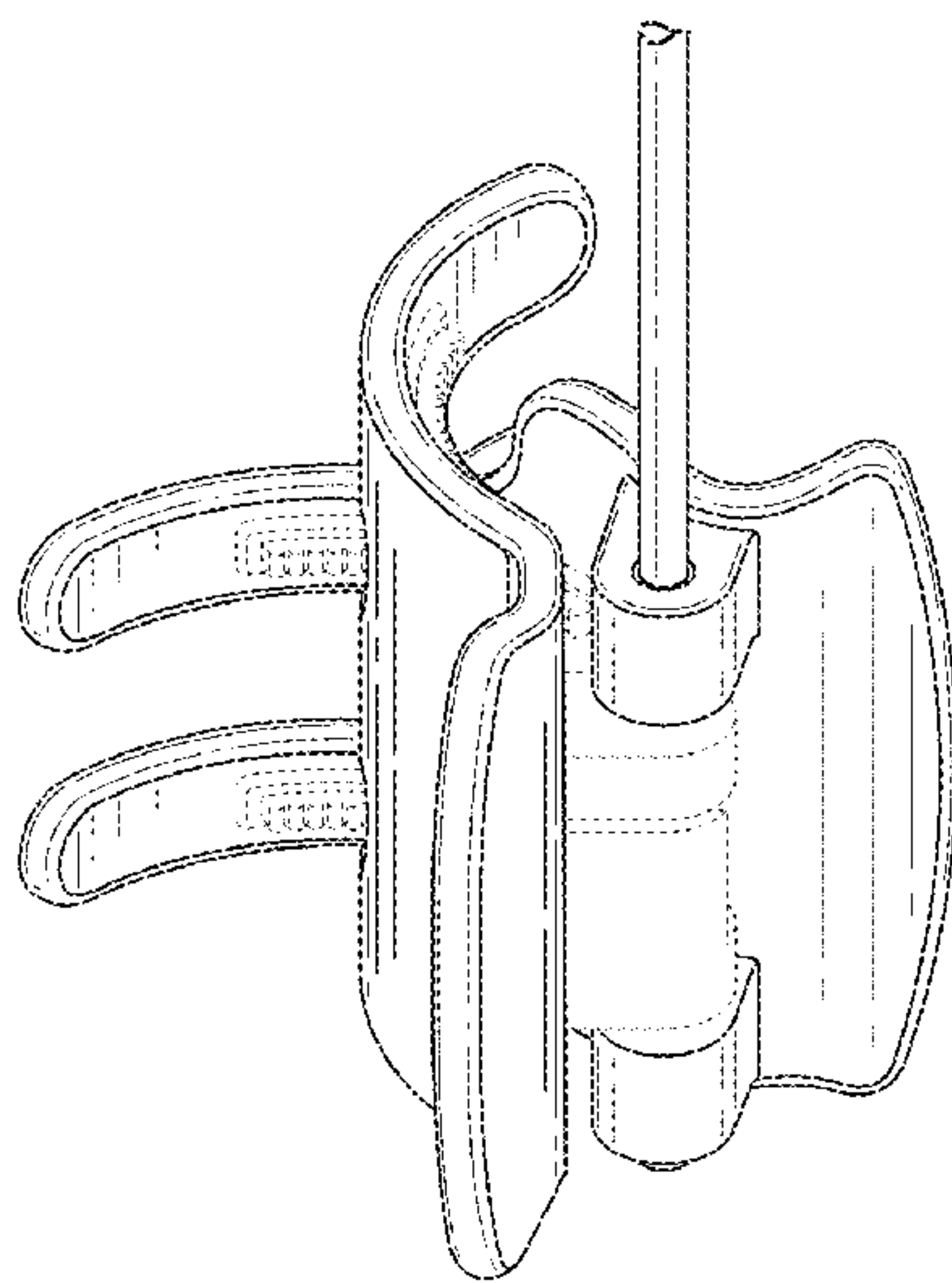

(56)

References Cited

U.S. PATENT DOCUMENTS

8,186,364	B2 *	5/2012	Silva	132/275
8,276,598	B1 *	10/2012	Shepard et al.	132/275
8,863,761	B2 *	10/2014	Wang	132/277
2007/0029222	A1	2/2007	Shepardson	
2007/0031635	A1	2/2007	Shepardson	
2010/0096526	A1	4/2010	Richardson	
2011/0114807	A1	5/2011	Richardson	

OTHER PUBLICATIONS

“Candle Clip-On Ornaments”, printed from <http://store.gianis.com/gm501r.html> available at least as early as Sep. 14, 2011 (1 page).
Photograph of Hair Clip, (1 page).

“What is it with Boys Being Obsessed with Hair Clips?” printed from <http://sheenaspace.wordpress.com/2012/05/01/what-is-it-with-boys-being-obsessed-with-hair-clips/> published May 1, 2012 (2 pages).

“Club Pack of 24 Red and Gold Glass Candle Clip-On Christmas Ornaments 5.5”, printed from <http://shop.christmascentral.com/items/item.aspx?itemid=10836187> available at least as early as Sep. 14, 2011 (2 pages).

“Classic Medium Claw Clips”, printed from www.goody.com/Products/Hair_Accessories/Classics_Medium_Claw_Clips, (1 page).

“Holiday Hair”, printed from www.styleblueprint.com/health-and-beauty/holiday-hair/ posted on Dec. 8, 2011 (7 pages).

* cited by examiner

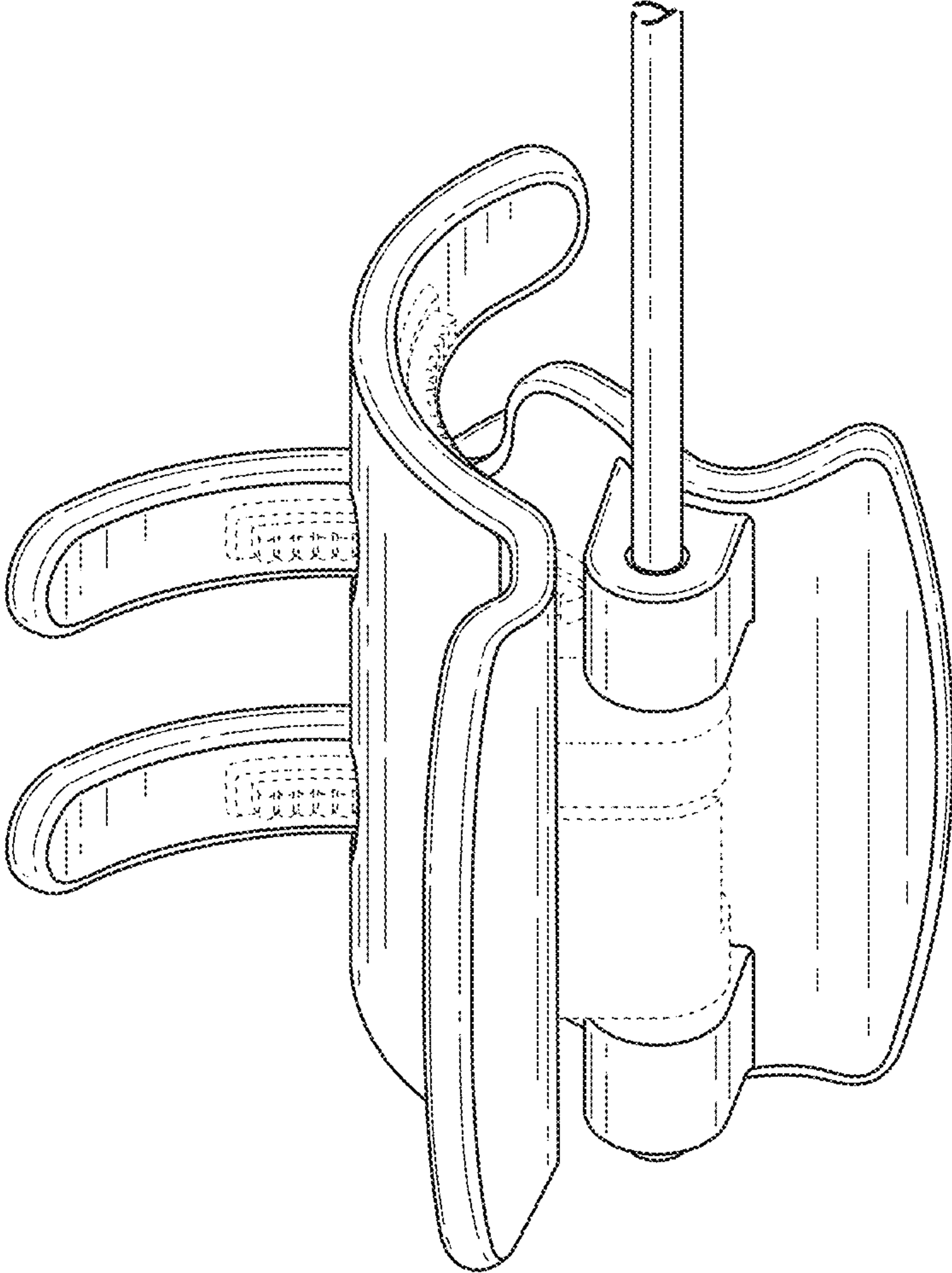

FIG. 1

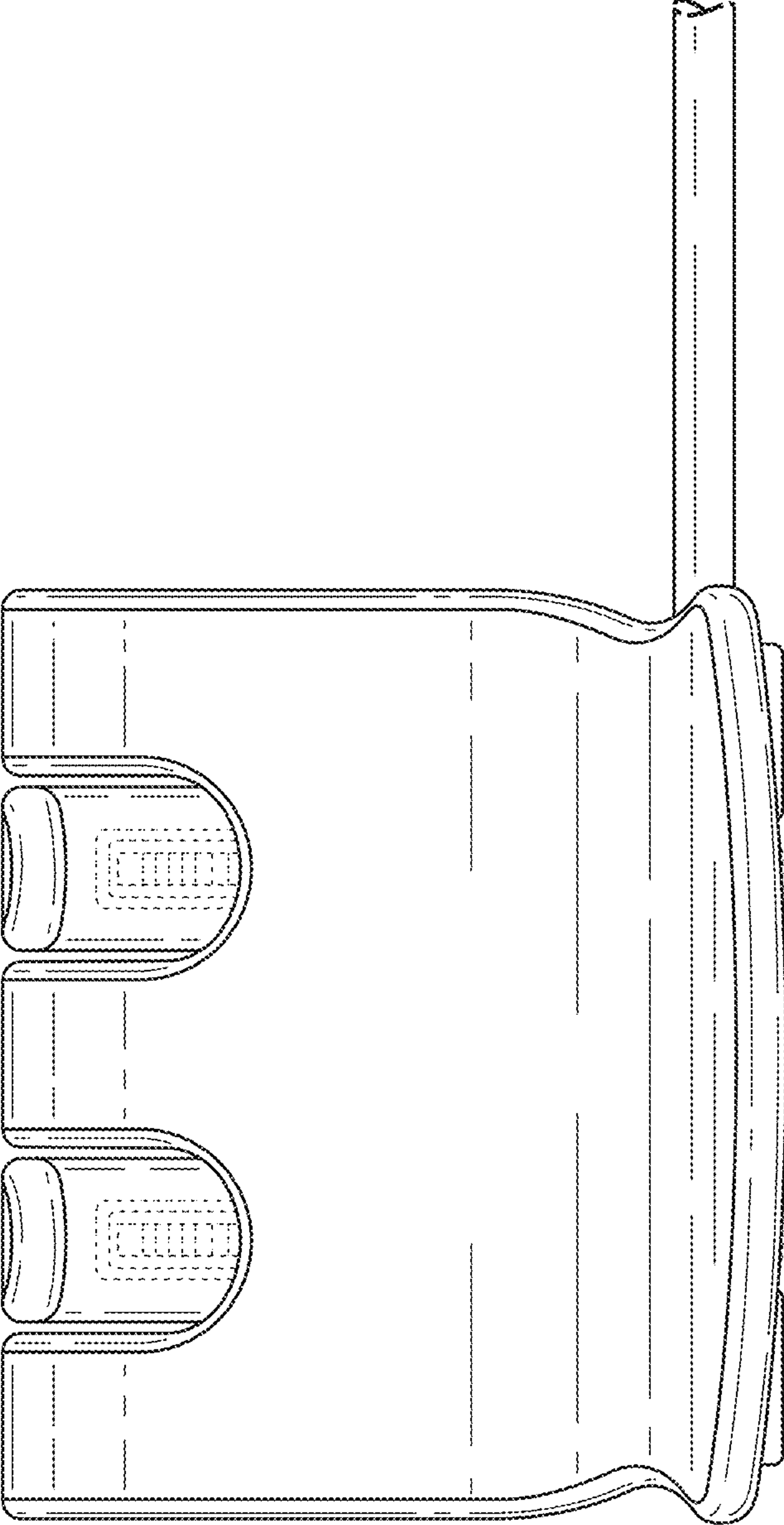

FIG. 2

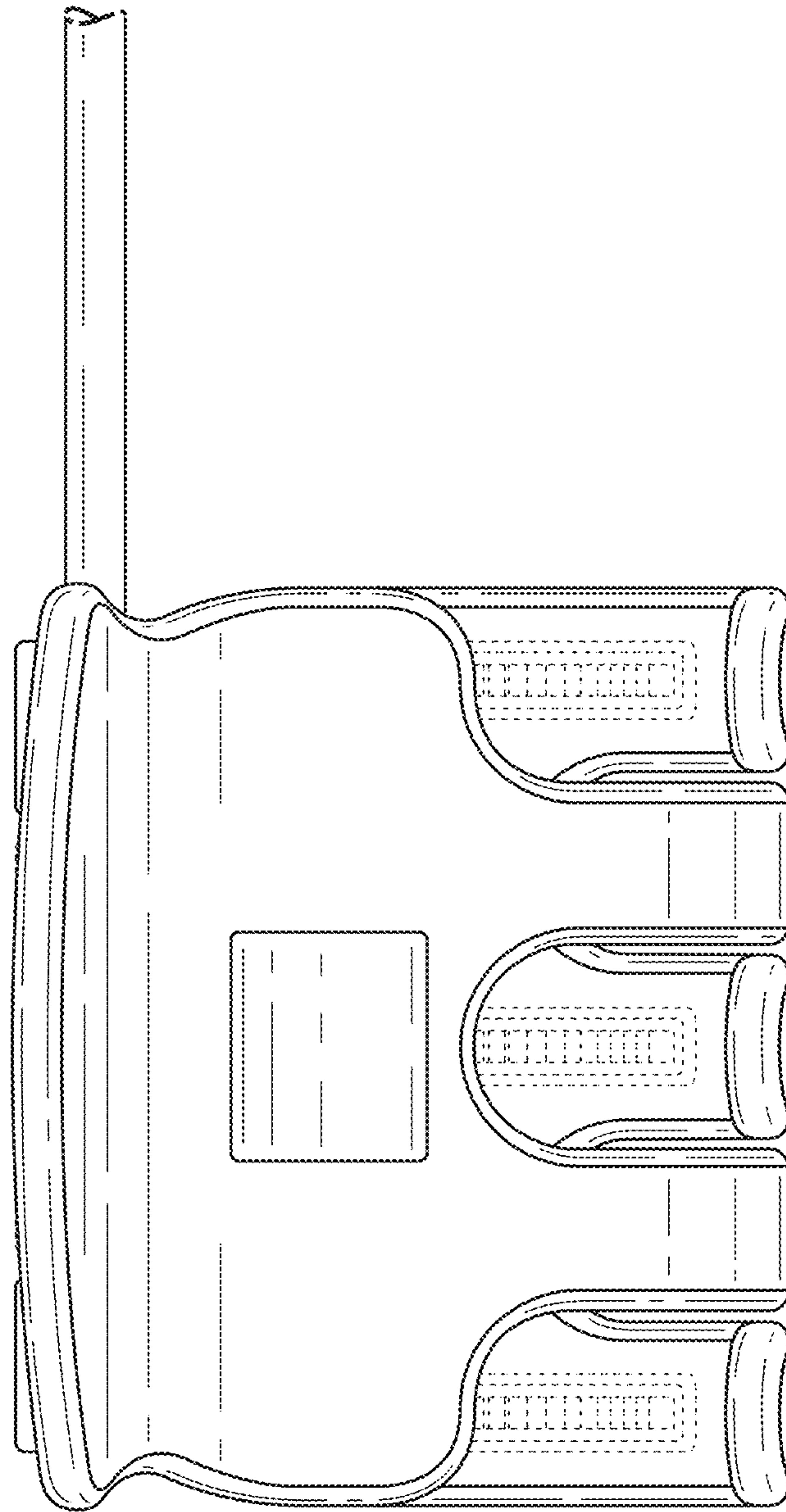

FIG. 3

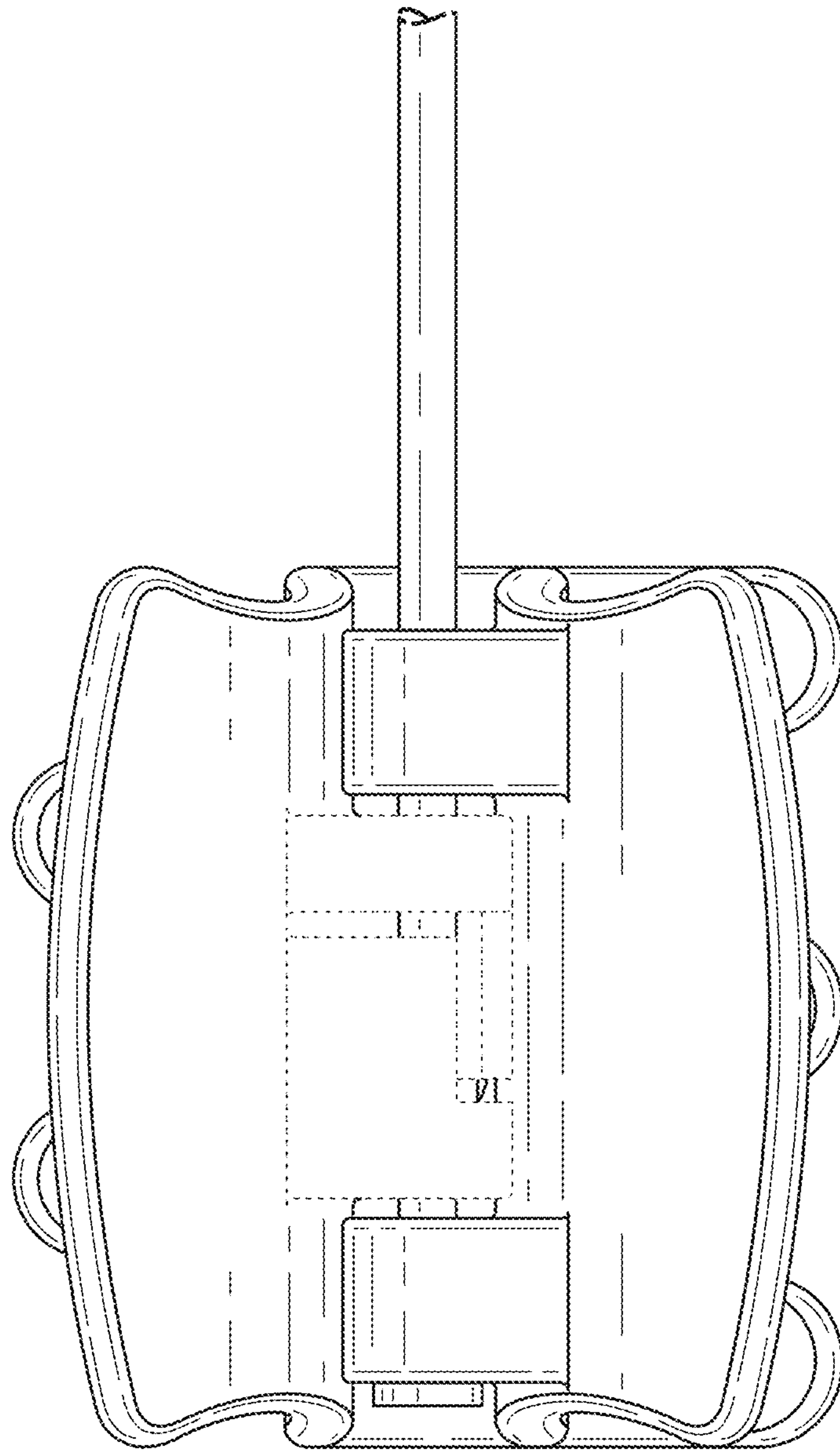

FIG. 4

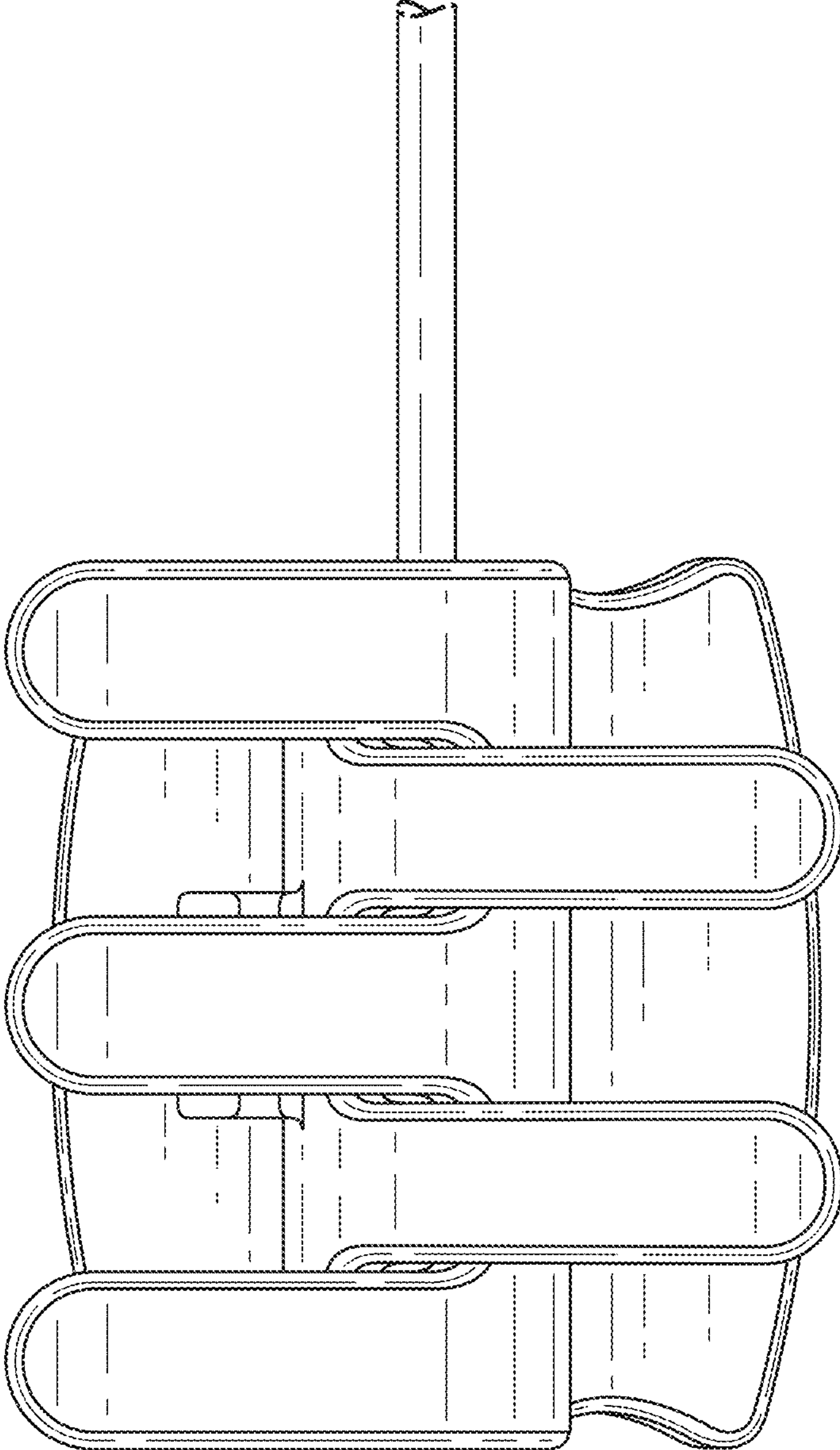

FIG. 5

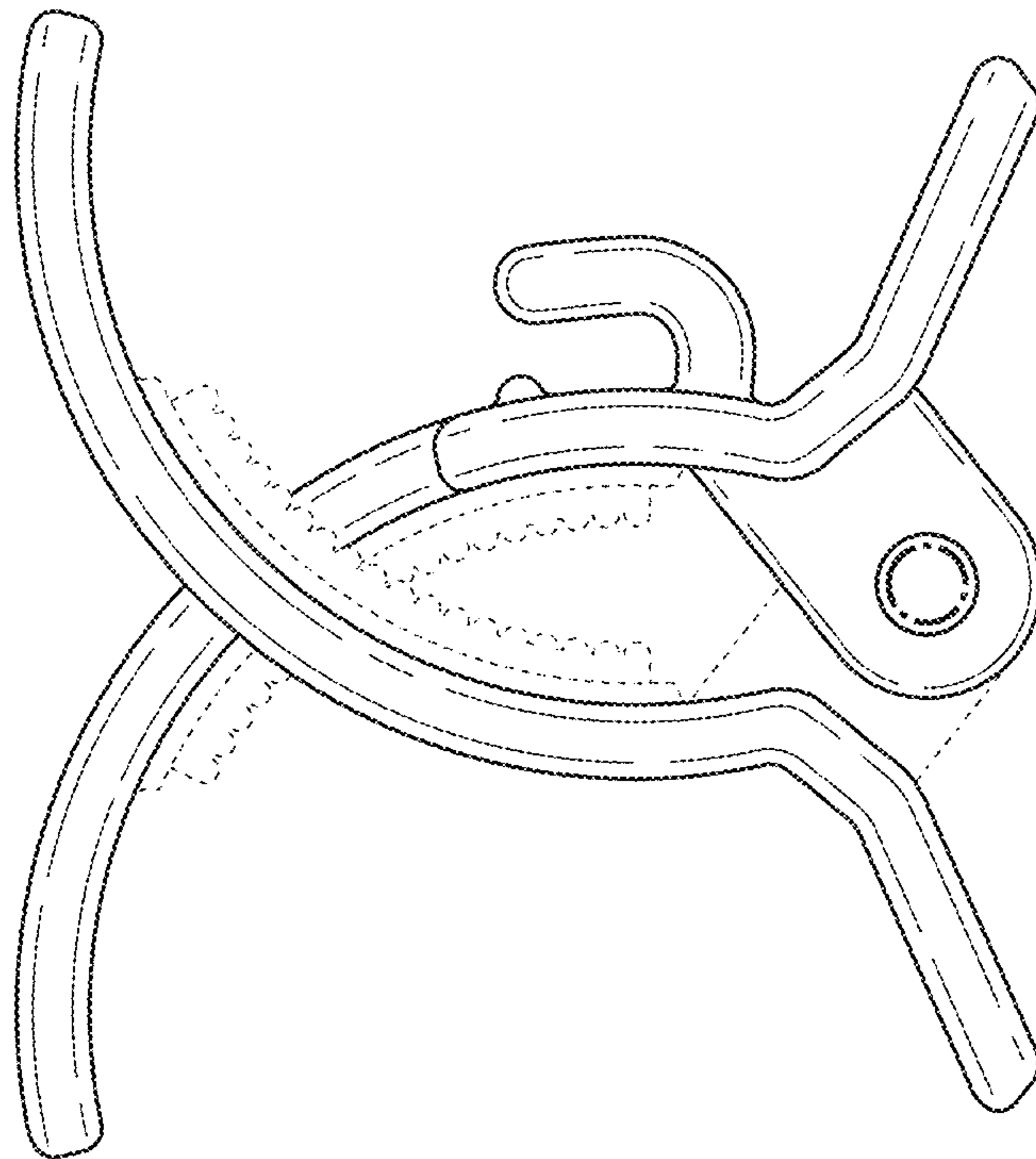

FIG. 6

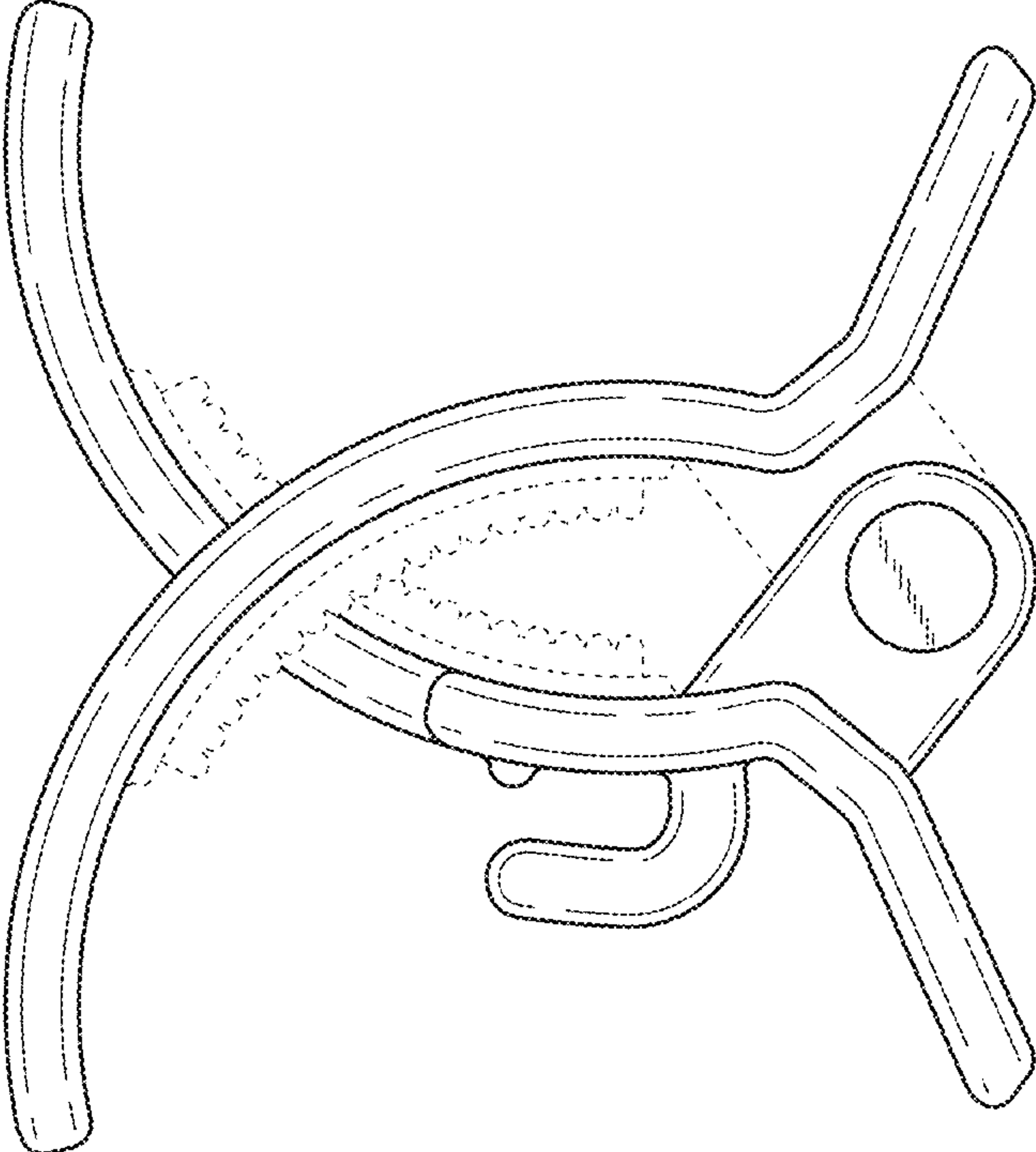

FIG. 7

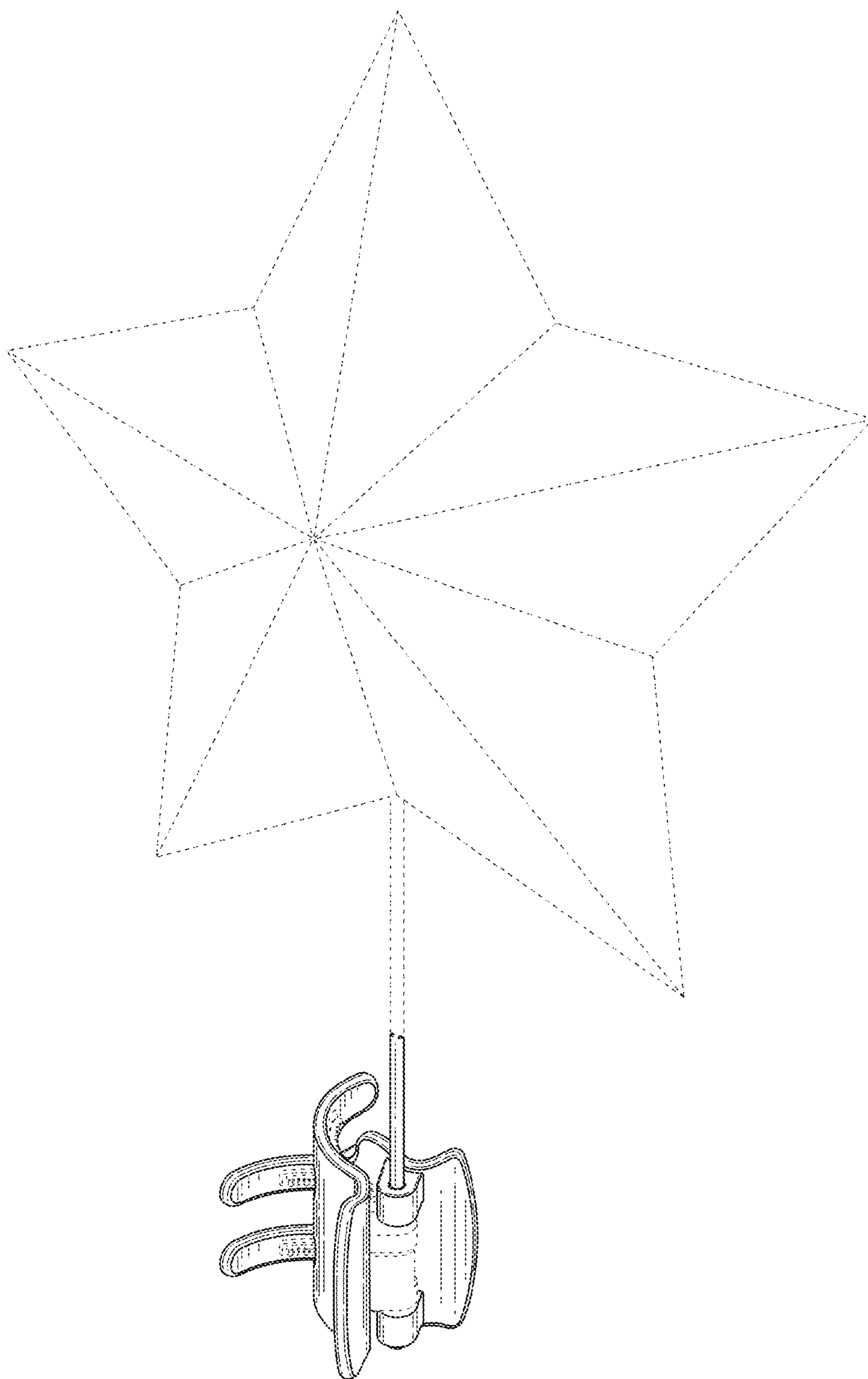

FIG. 8

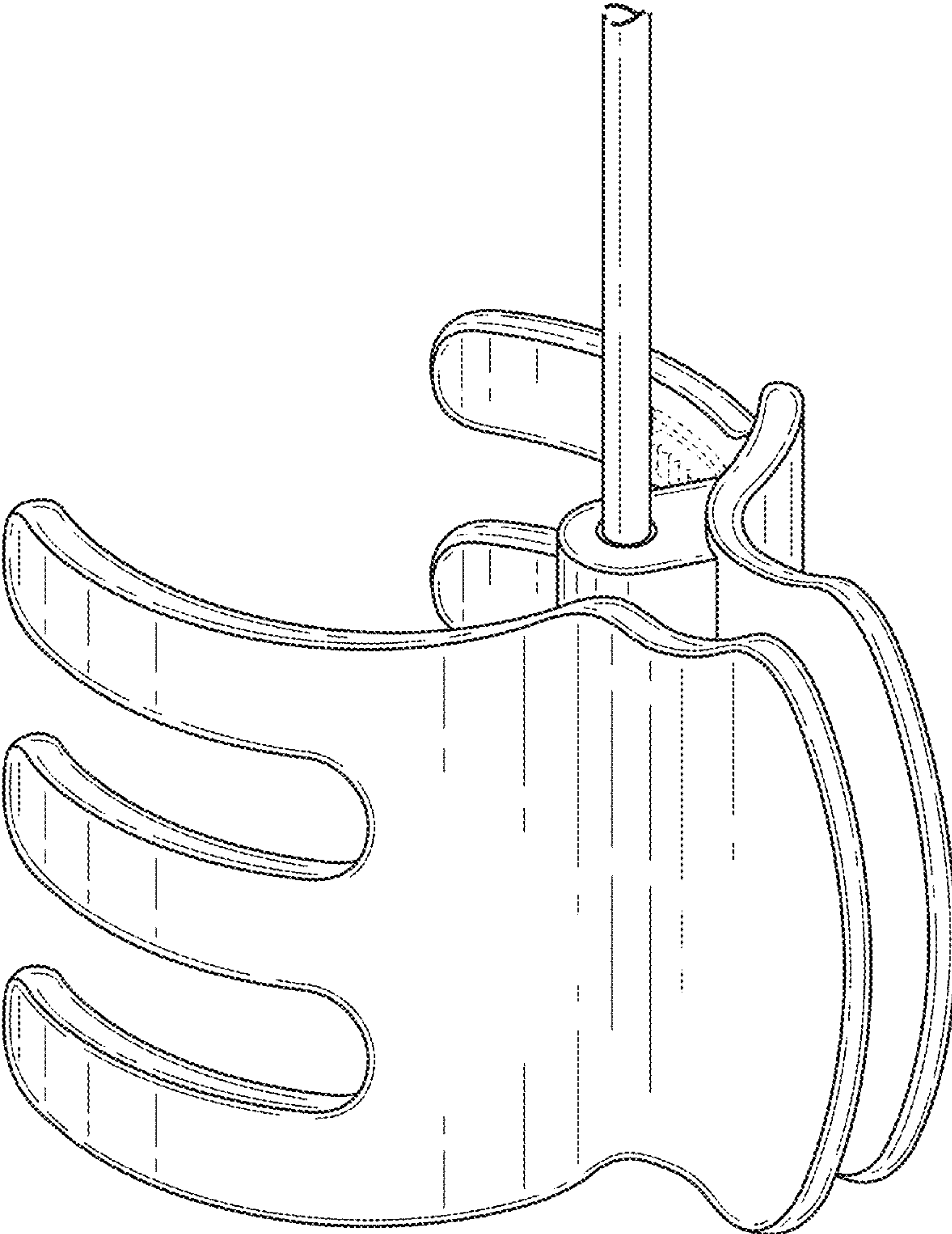

FIG. 9

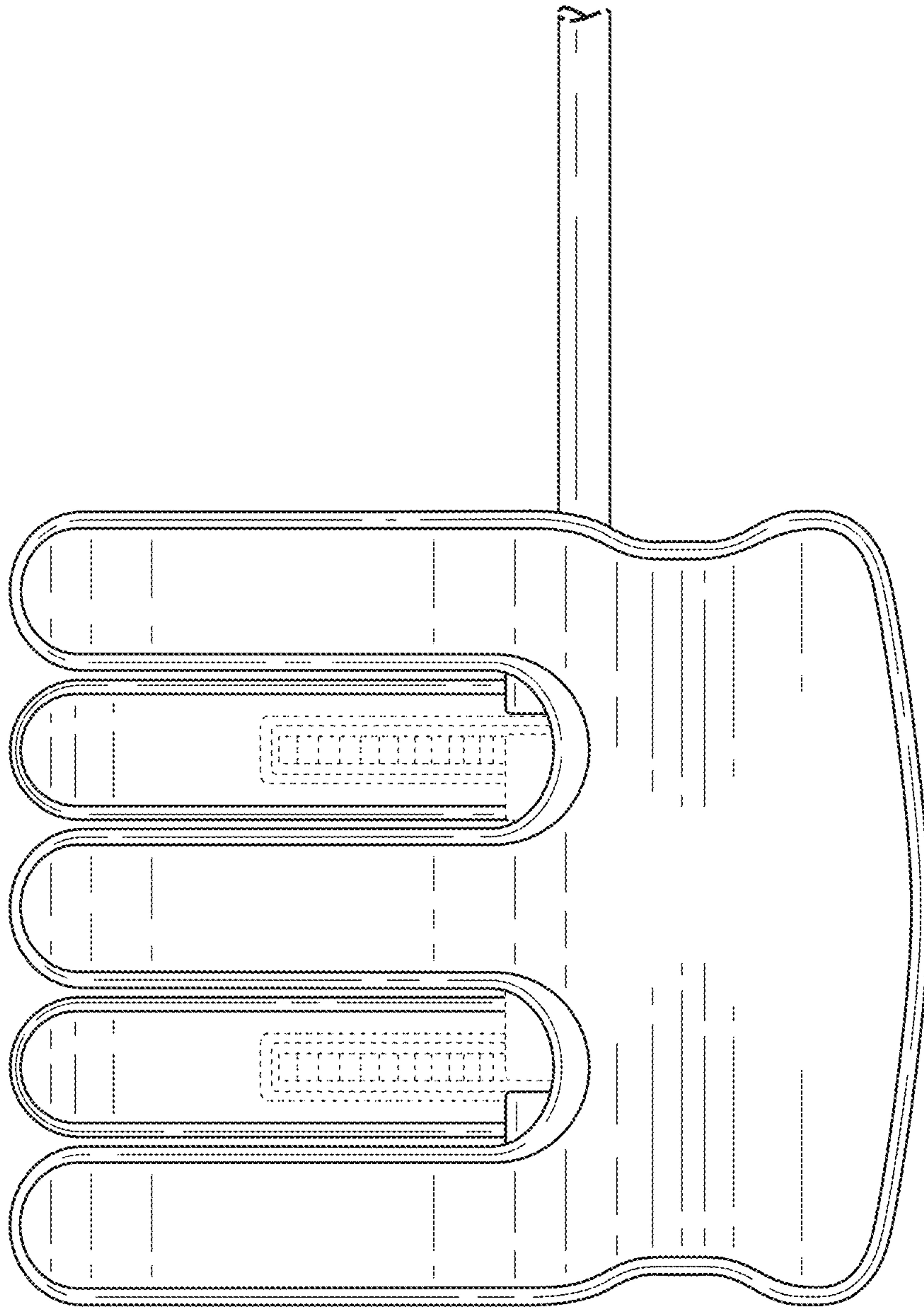

FIG. 10

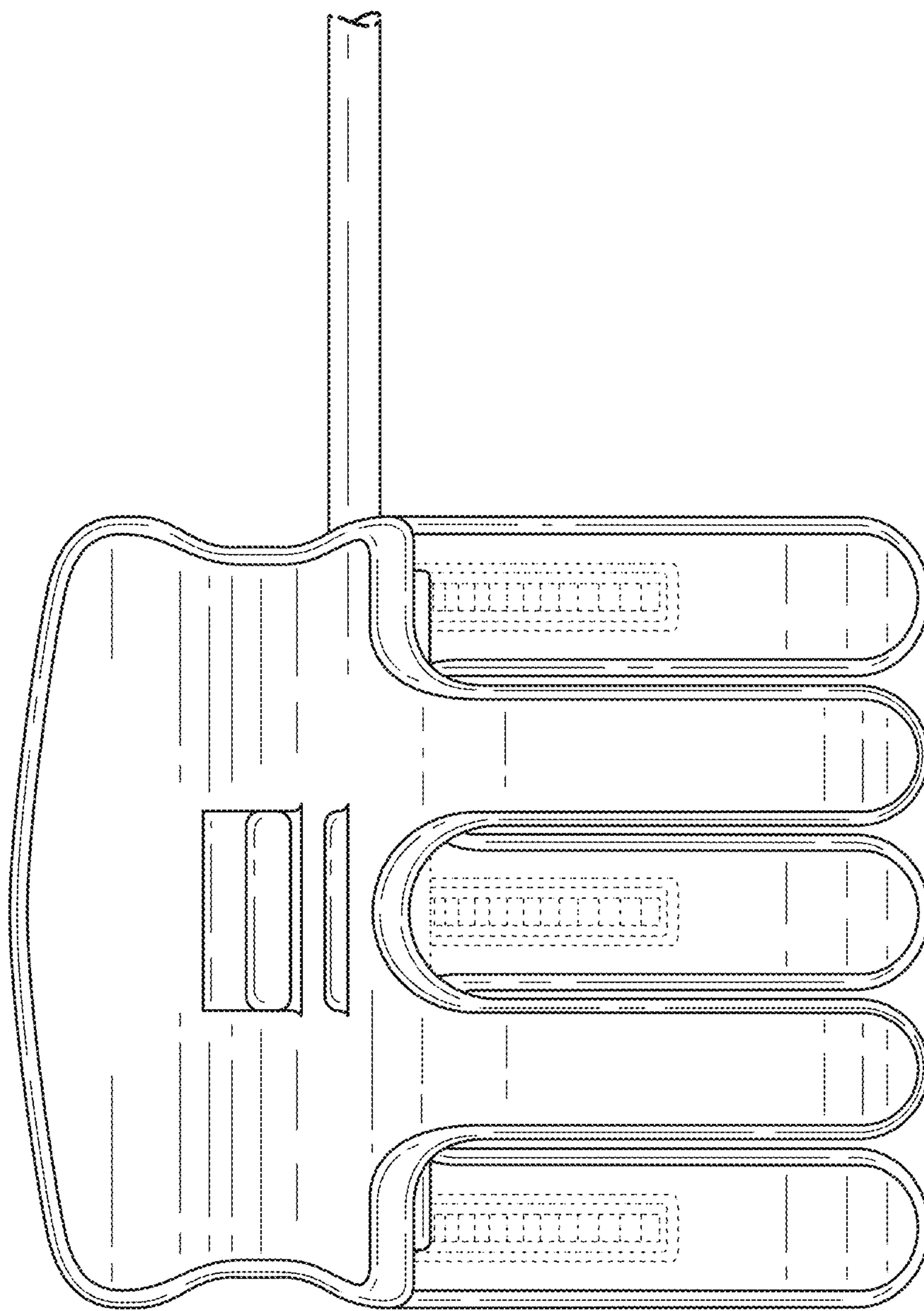

FIG. 11

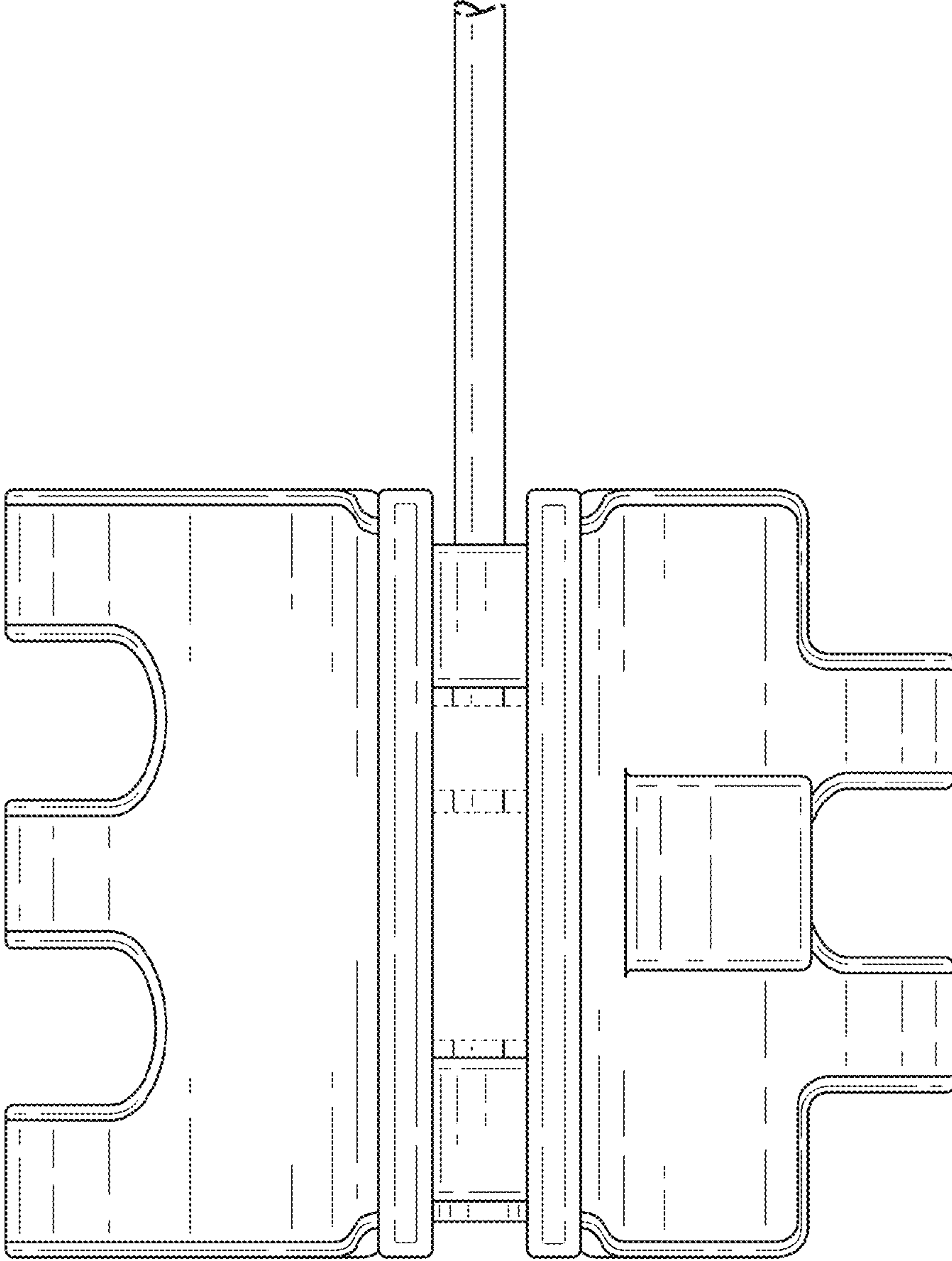

FIG. 12

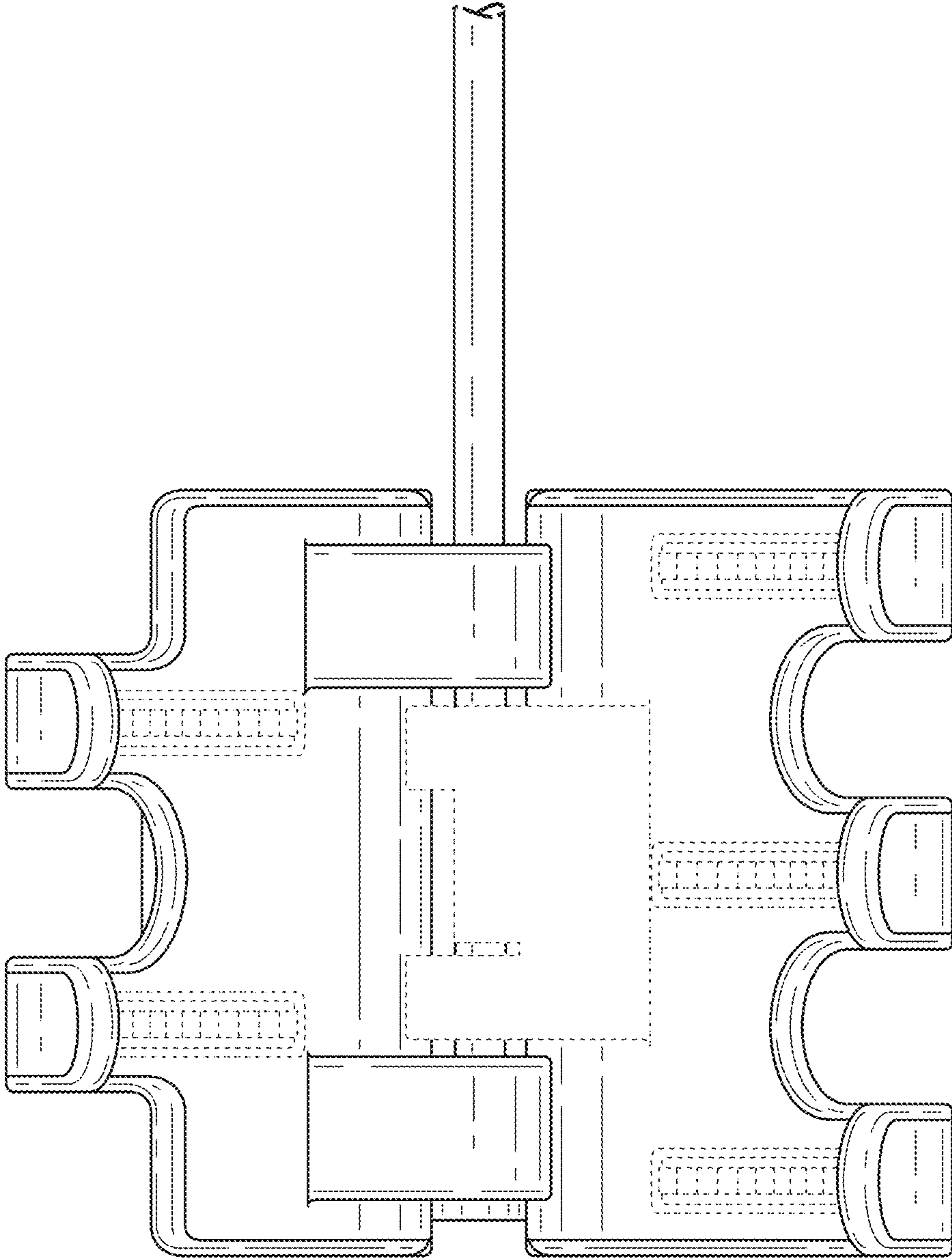

FIG. 13

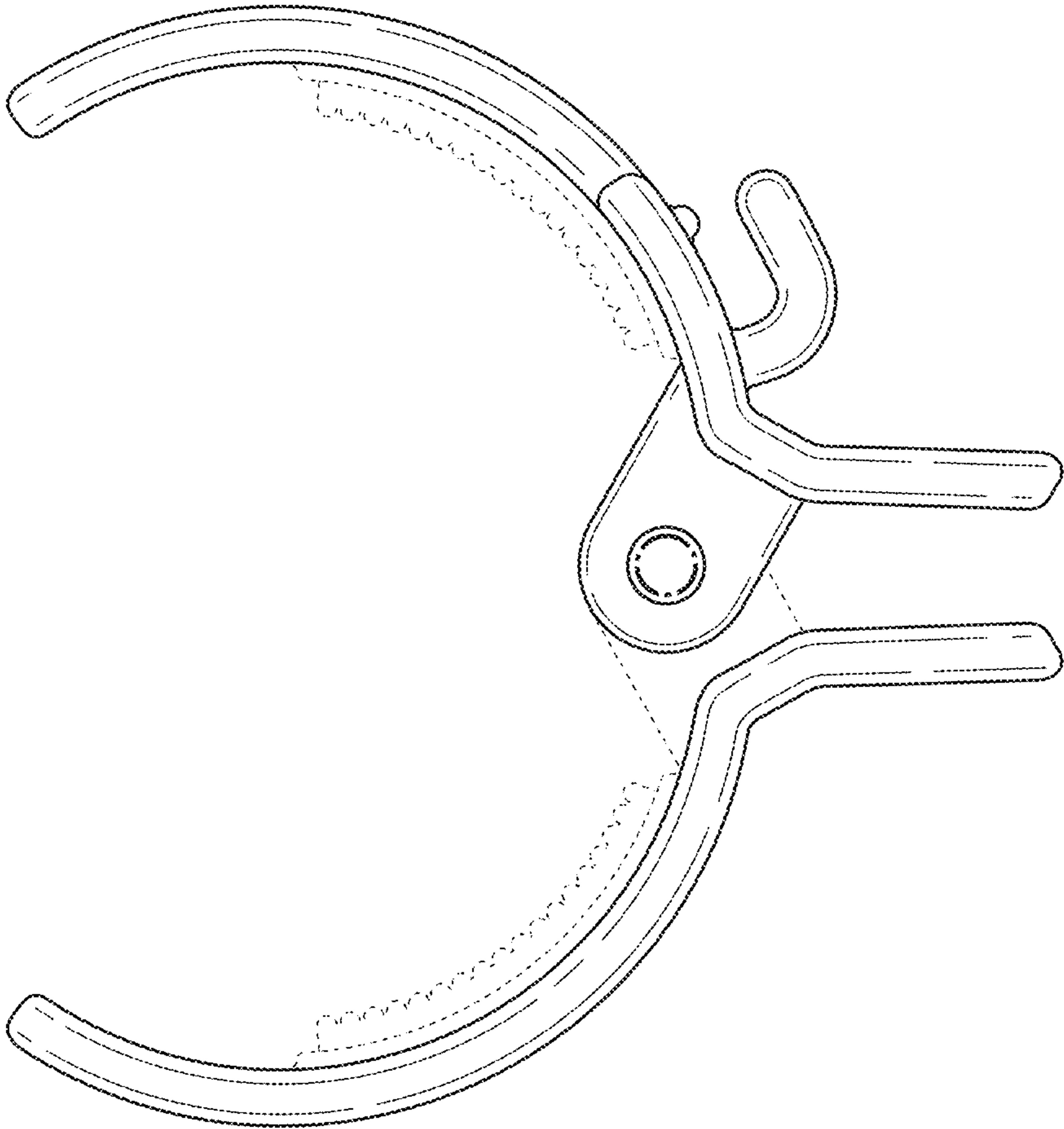

FIG. 14

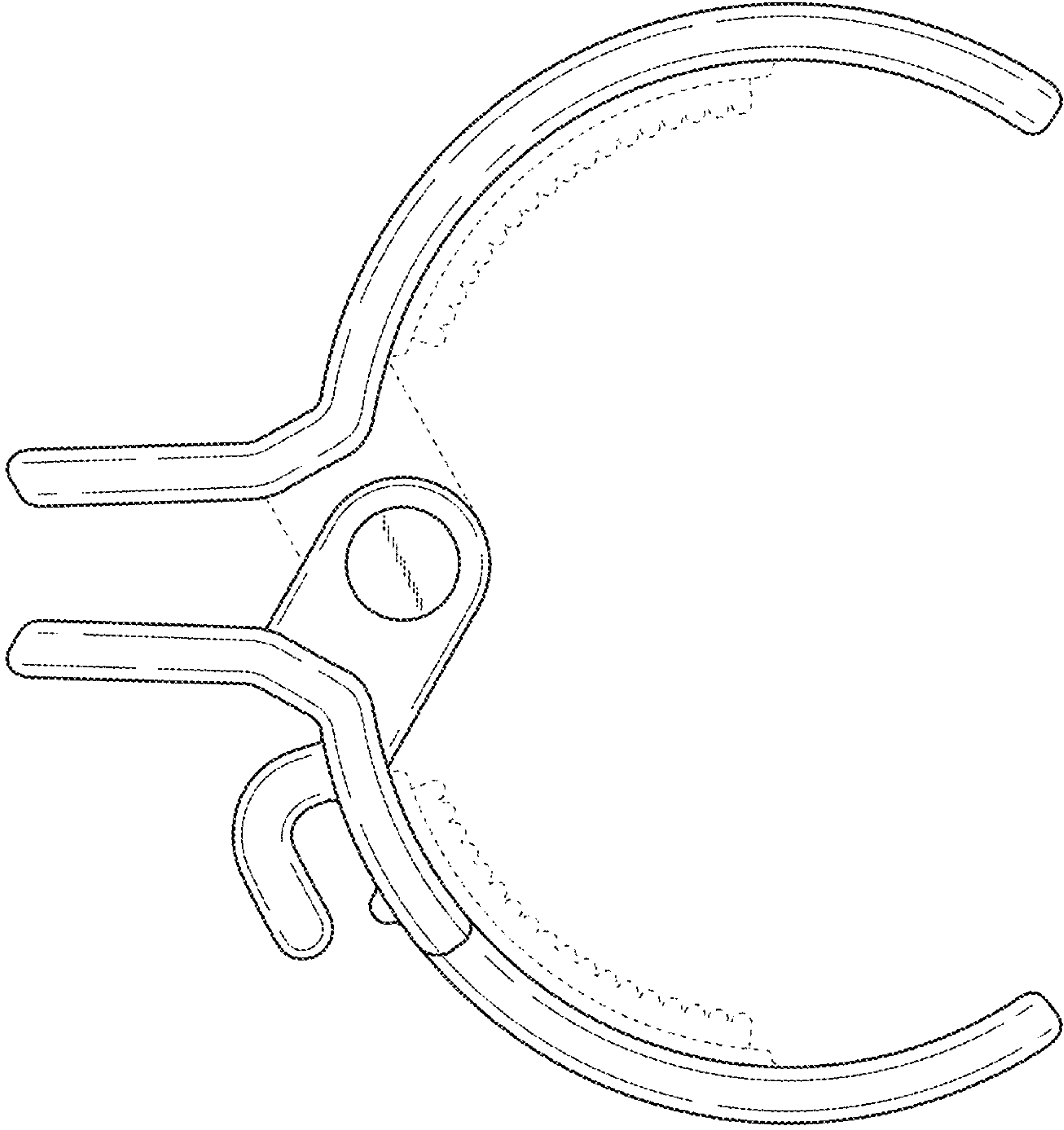

FIG. 15