

US00D736028S

(12) **United States Design Patent**  
**Baacke et al.**

(10) **Patent No.:** **US D736,028 S**  
(45) **Date of Patent:** **\*\* Aug. 11, 2015**

(54) **BUILT-IN HOME APPLIANCE**

(71) Applicant: **BSH Bosch und Siemens Hausgeräte GmbH**, Munich (DE)

(72) Inventors: **Sven Baacke**, München (DE); **Janina Fey**, München (DE); **Gerd Wilsdorf**, Olching (DE)

(73) Assignee: **BSH Bosch und Siemens Hausgeraete GmbH**, Munich (DE)

(\*\*) Term: **14 Years**

(21) Appl. No.: **29/445,436**

(22) Filed: **Feb. 12, 2013**

(30) **Foreign Application Priority Data**

Aug. 16, 2012 (EM) ..... 001341598

(51) **LOC (10) Cl.** ..... **07-02**

(52) **U.S. Cl.**  
USPC ..... **D7/348**

(58) **Field of Classification Search**  
USPC ..... D7/339-349  
CPC ..... F24C 3/00-3/14; F24C 7/00-7/105;  
F24C 14/00-14/025; F24C 15/00-15/18  
See application file for complete search history.

(56) **References Cited**

**U.S. PATENT DOCUMENTS**

3,130,719 A \* 4/1964 Mayer et al. .... 126/37 B  
D202,317 S \* 9/1965 Waltman ..... D7/349  
D243,223 S \* 2/1977 Suganoya et al. .... D7/351  
5,042,458 A \* 8/1991 Spencer et al. .... 126/299 R  
D443,178 S \* 6/2001 Segers ..... D7/405

\* cited by examiner

*Primary Examiner* — Mitchell Siegel

(74) *Attorney, Agent, or Firm* — James E. Howard; Andre Pallapies

(57) **CLAIM**

The ornamental design for a built-in home appliance, as shown and described.

**DESCRIPTION**

FIG. 1 is a front perspective view of a built-in home appliance showing a first embodiment of our new design;

FIG. 2 is a front view thereof;

FIG. 3 is a rear view thereof;

FIG. 4 is a top view thereof;

FIG. 5 is a bottom view thereof;

FIG. 6 is a right side view thereof;

FIG. 7 is a left side view thereof;

FIG. 8 is a front perspective view of a built-in home appliance showing a second embodiment of our new design;

FIG. 9 is a front view thereof;

FIG. 10 is a rear view thereof;

FIG. 11 is a top view thereof;

FIG. 12 is a bottom view thereof;

FIG. 13 is a right side view thereof;

FIG. 14 is a left side view thereof;

FIG. 15 is a front perspective view of a built-in home appliance showing a third embodiment of our new design;

FIG. 16 is a front view thereof;

FIG. 17 is a rear view thereof;

FIG. 18 is a top view thereof;

FIG. 19 is a bottom view thereof;

FIG. 20 is a right side view thereof; and,

FIG. 21 is a left side view thereof.

Throughout the various figures of the drawings, certain views may not be provided. The omission of a particular view is intended to convey that the element(s) depicted is/are plain and unornamented in that omitted view, or that the particular ornamental appearance in that view is simply not claimed.

The broken lines showing environment or structure are for illustrative purposes only and form no part of the claimed design.

**1 Claim, 21 Drawing Sheets**

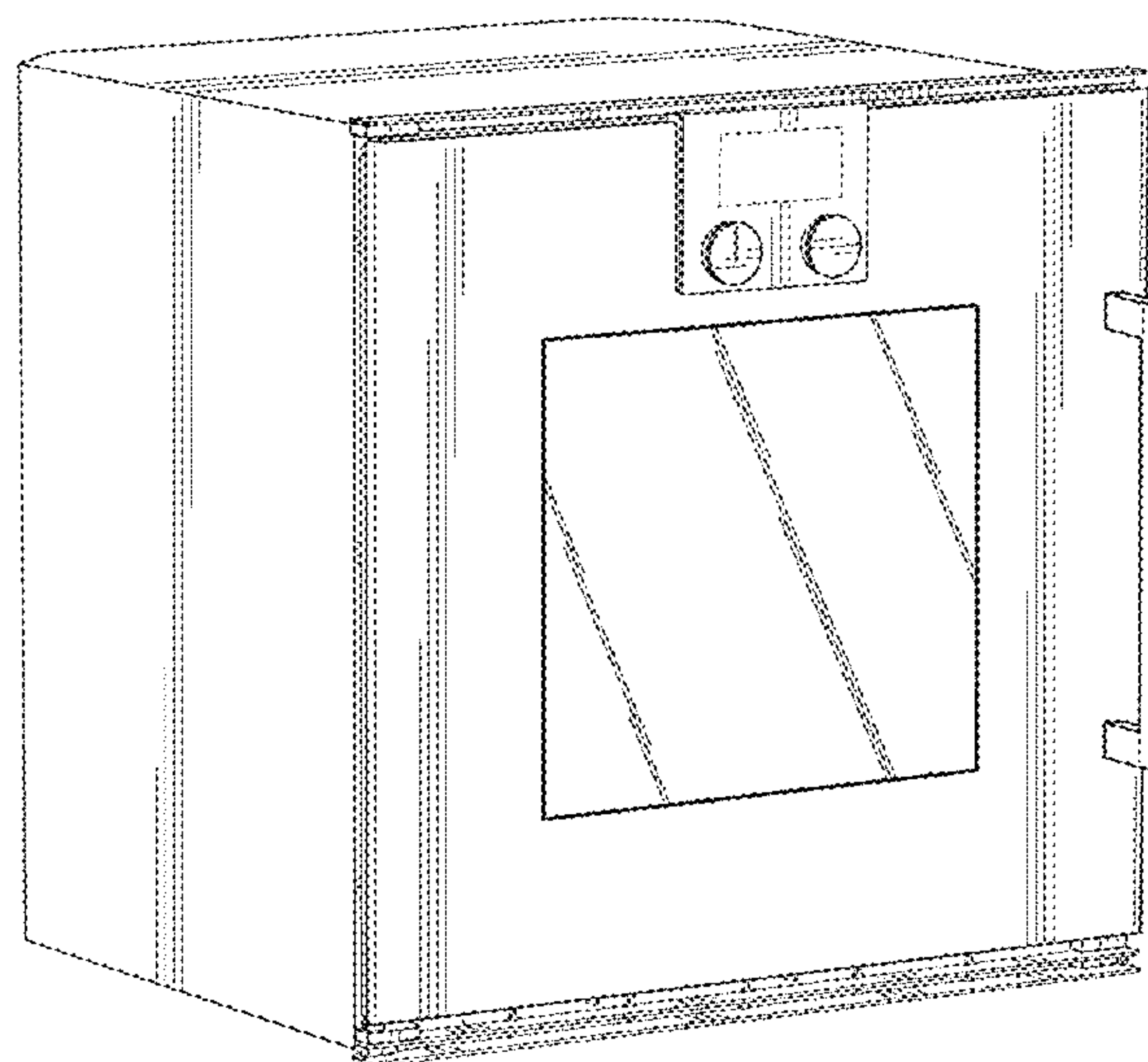
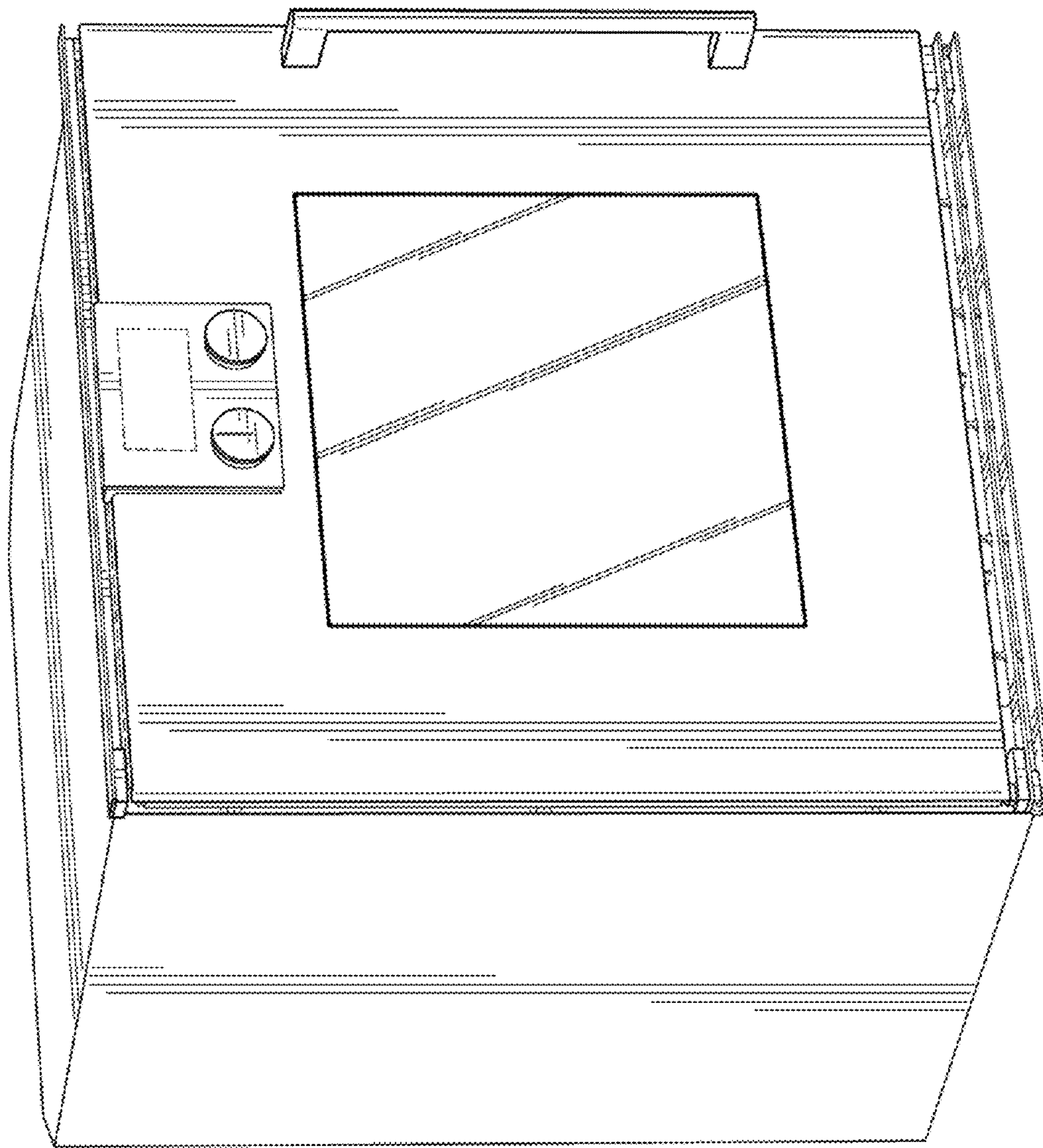

FIG. 1



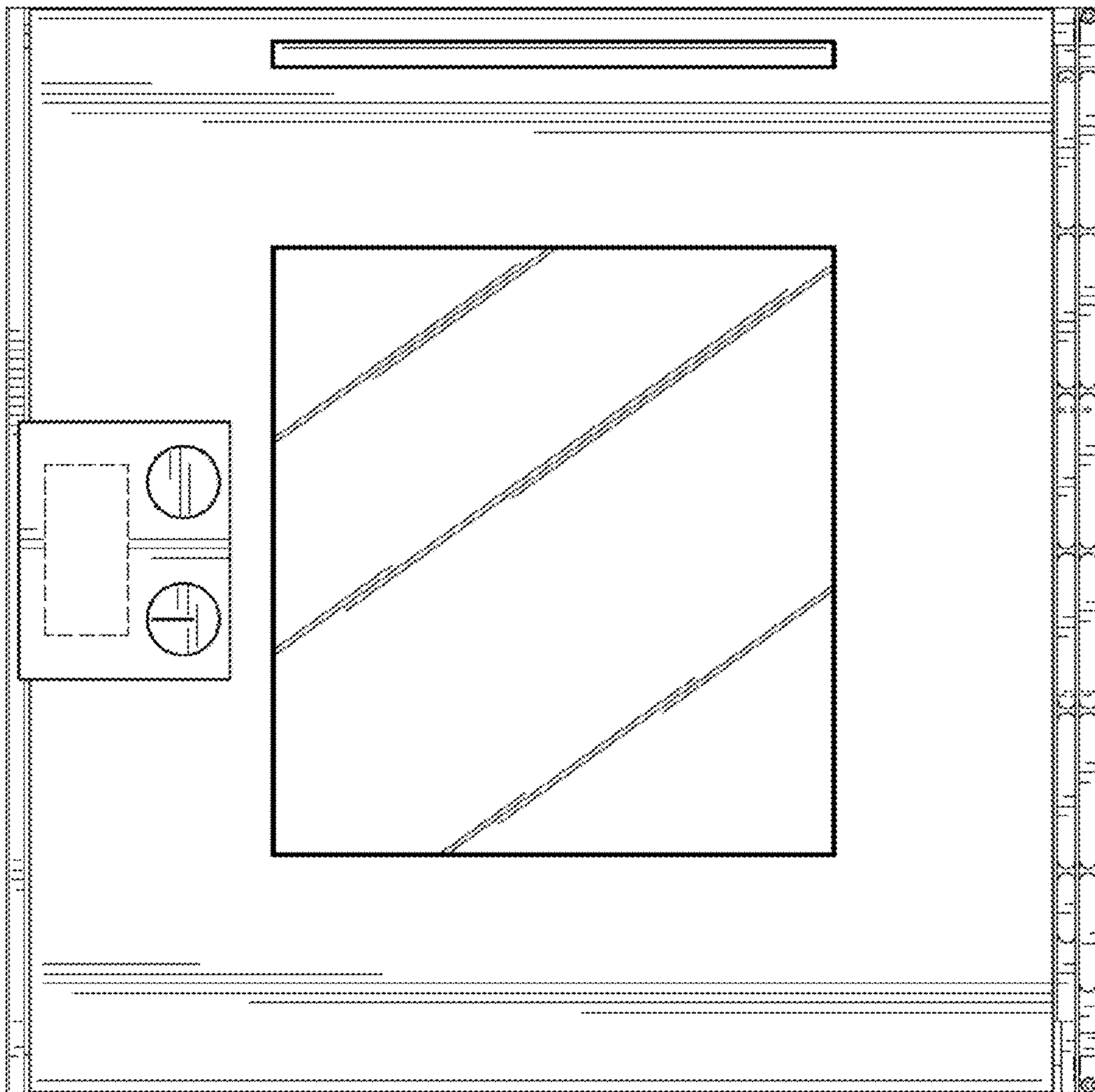
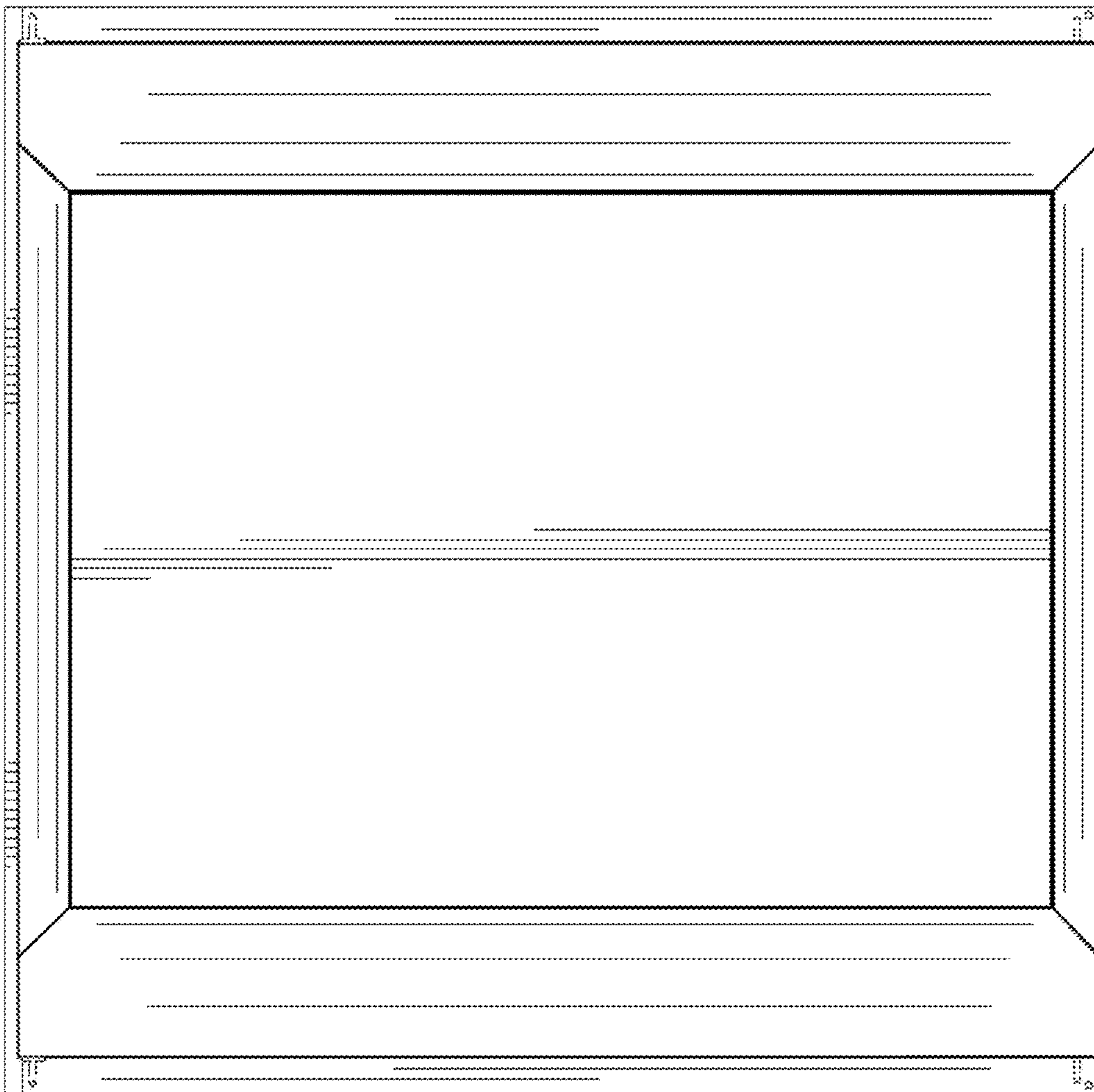

FIG. 2



FIG. 3



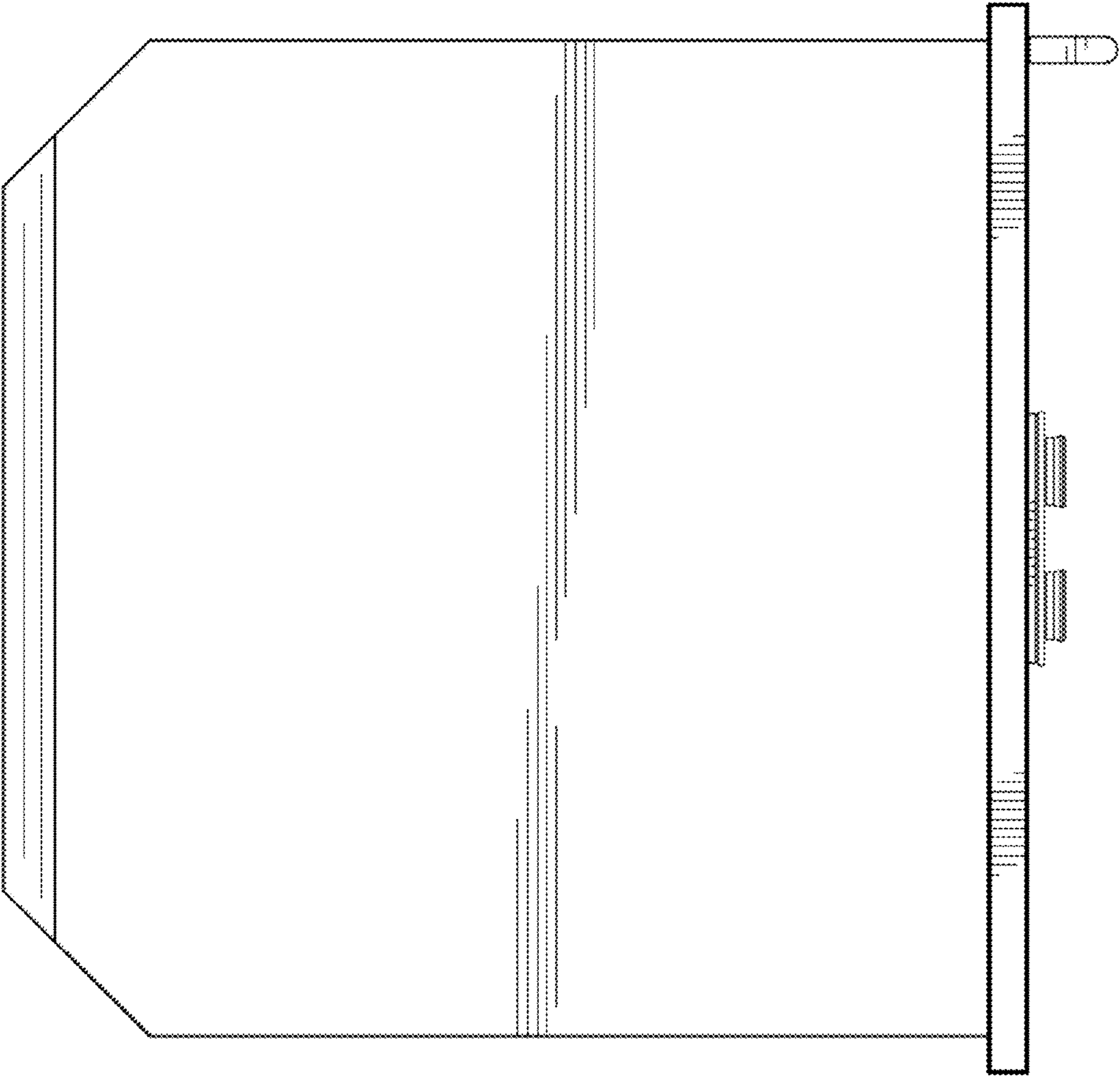

FIG. 4

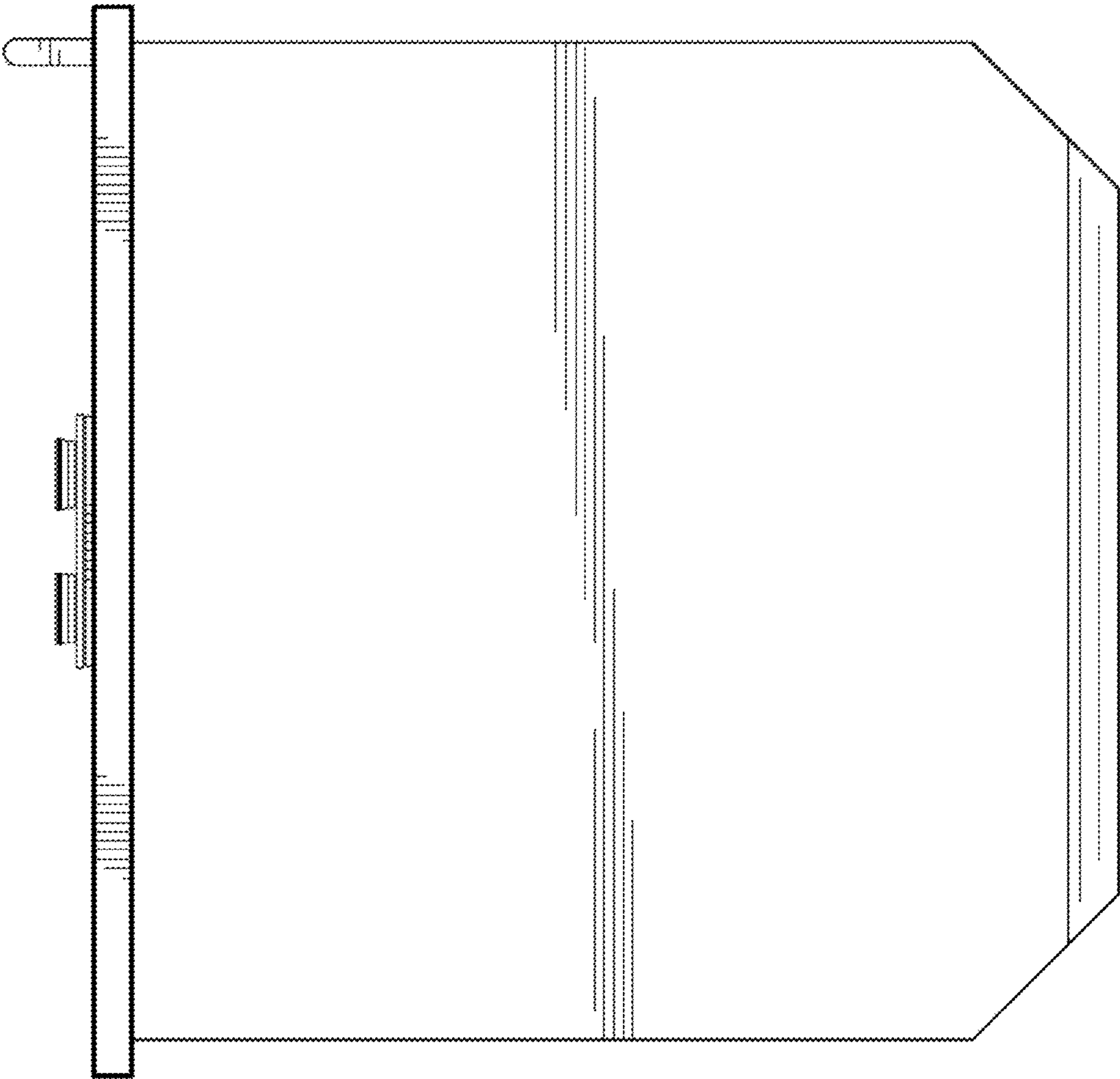

FIG. 5

FIG. 6

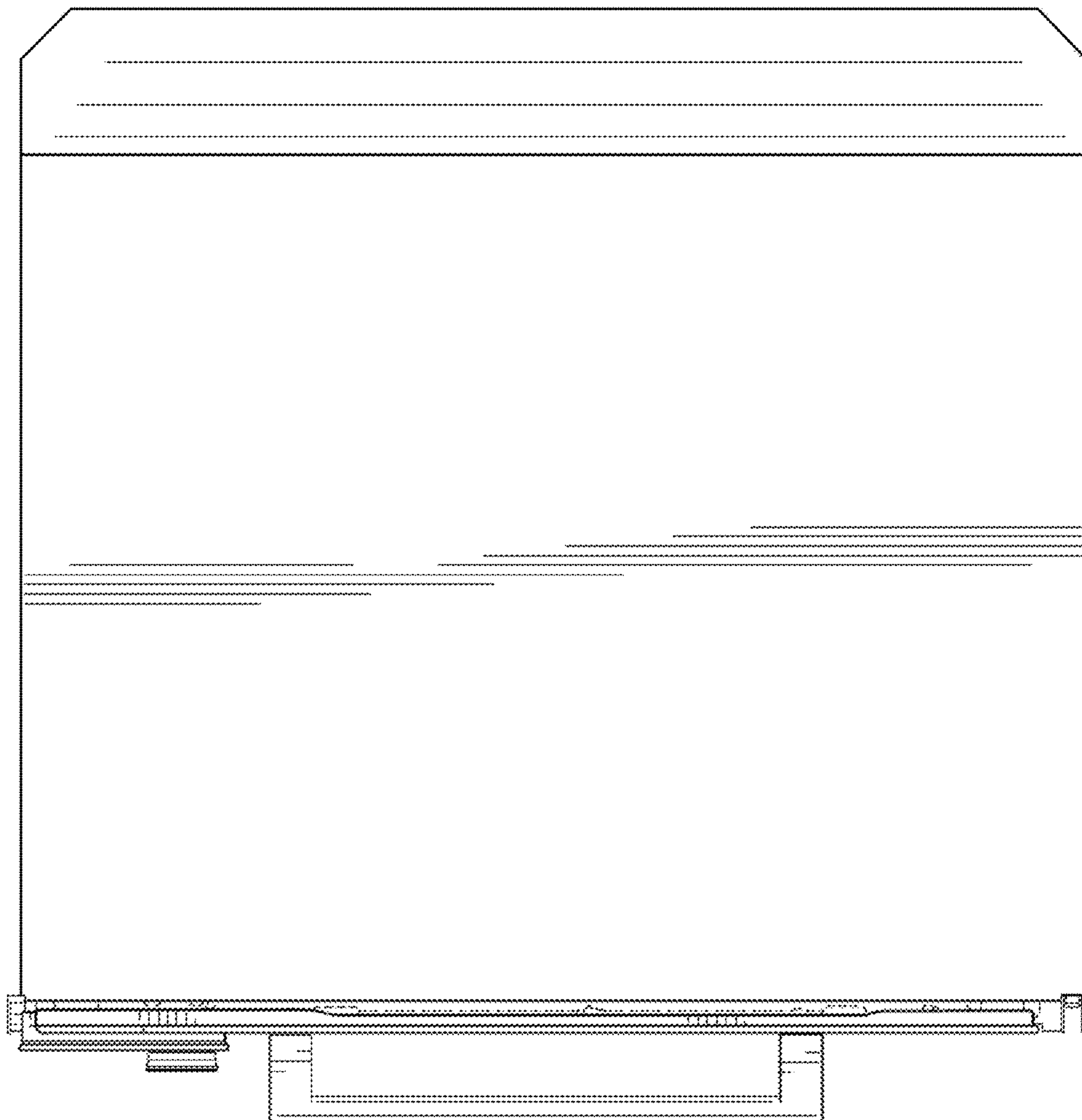
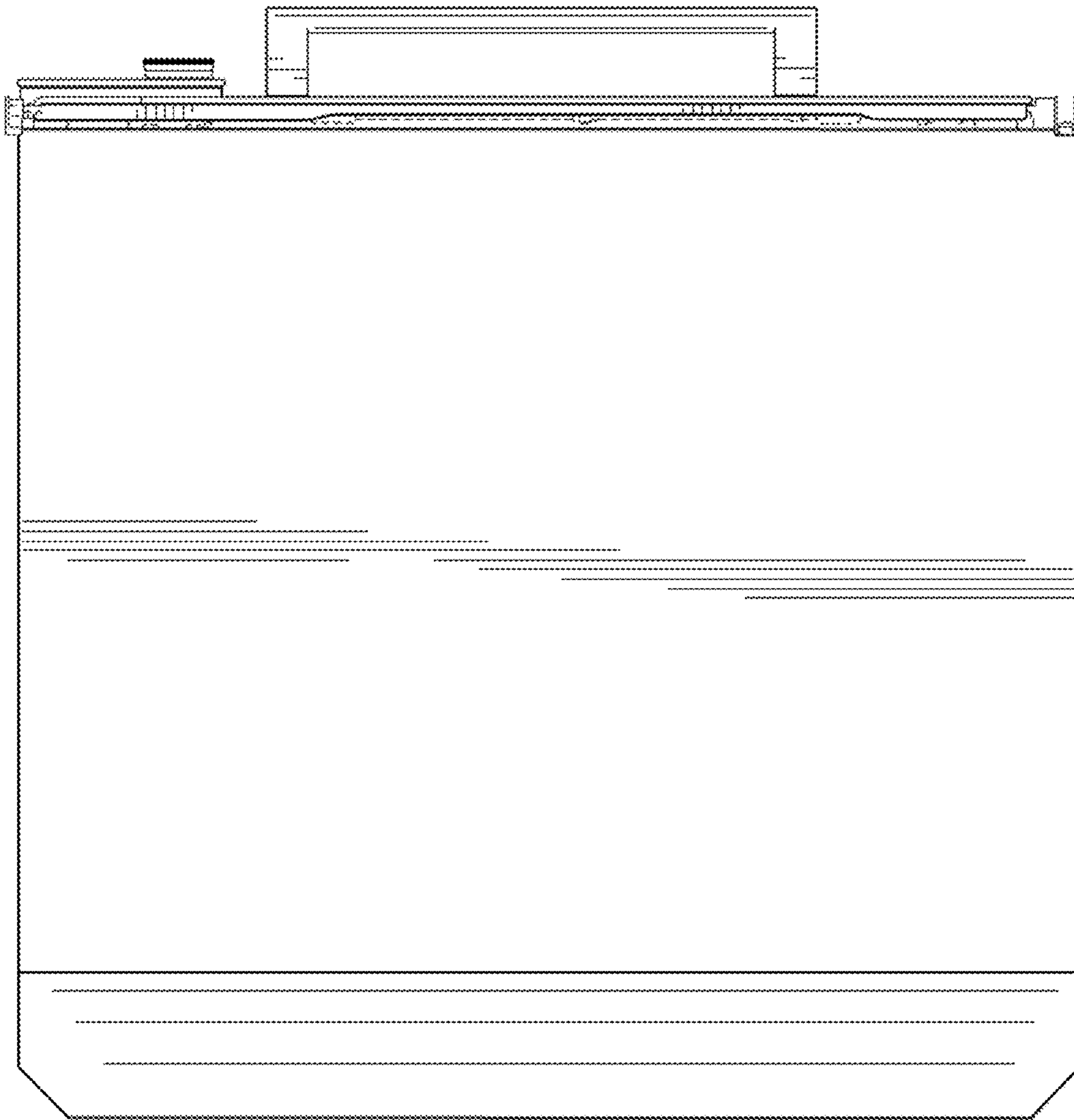

FIG. 7





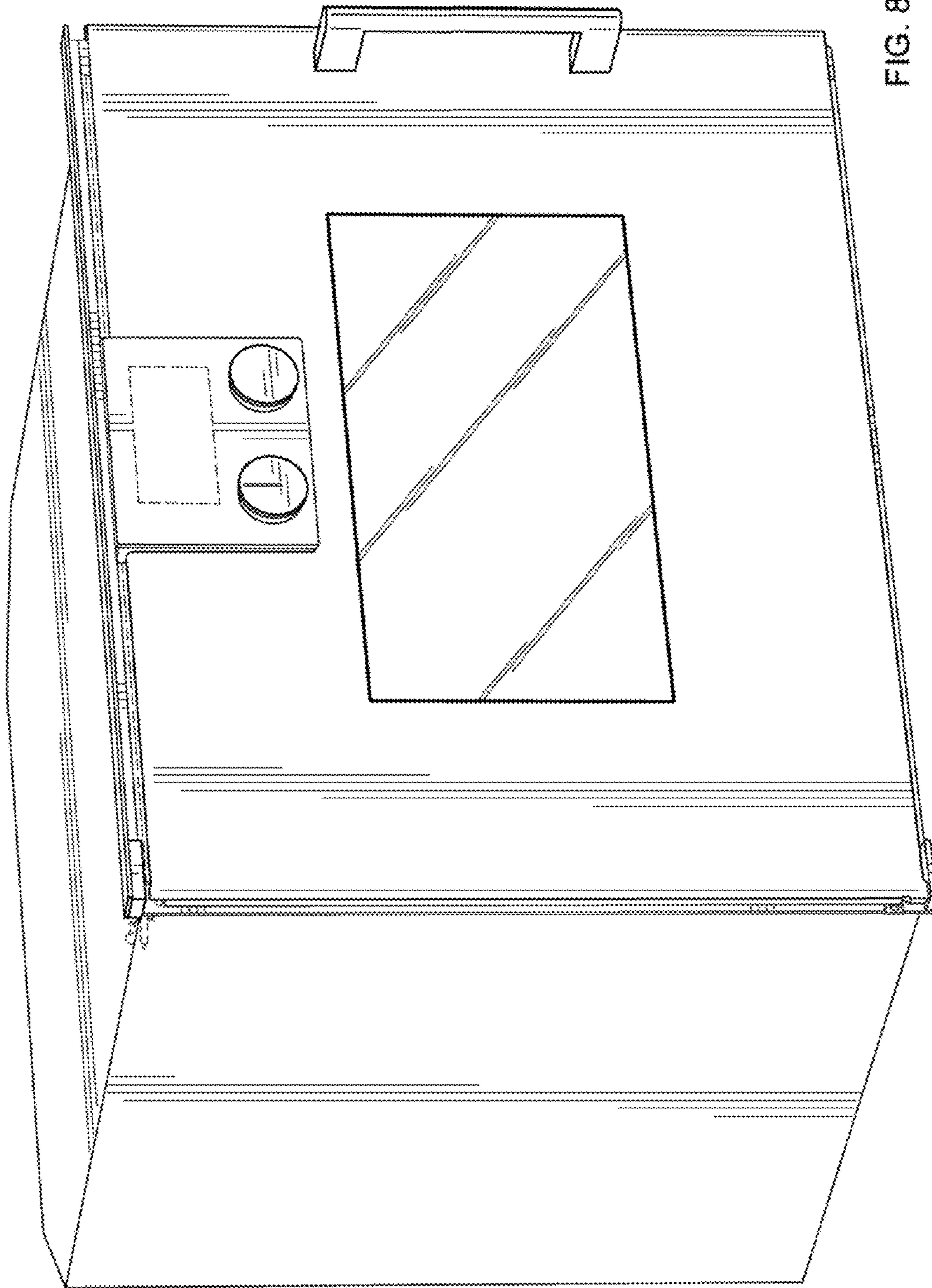

FIG. 8

FIG. 9

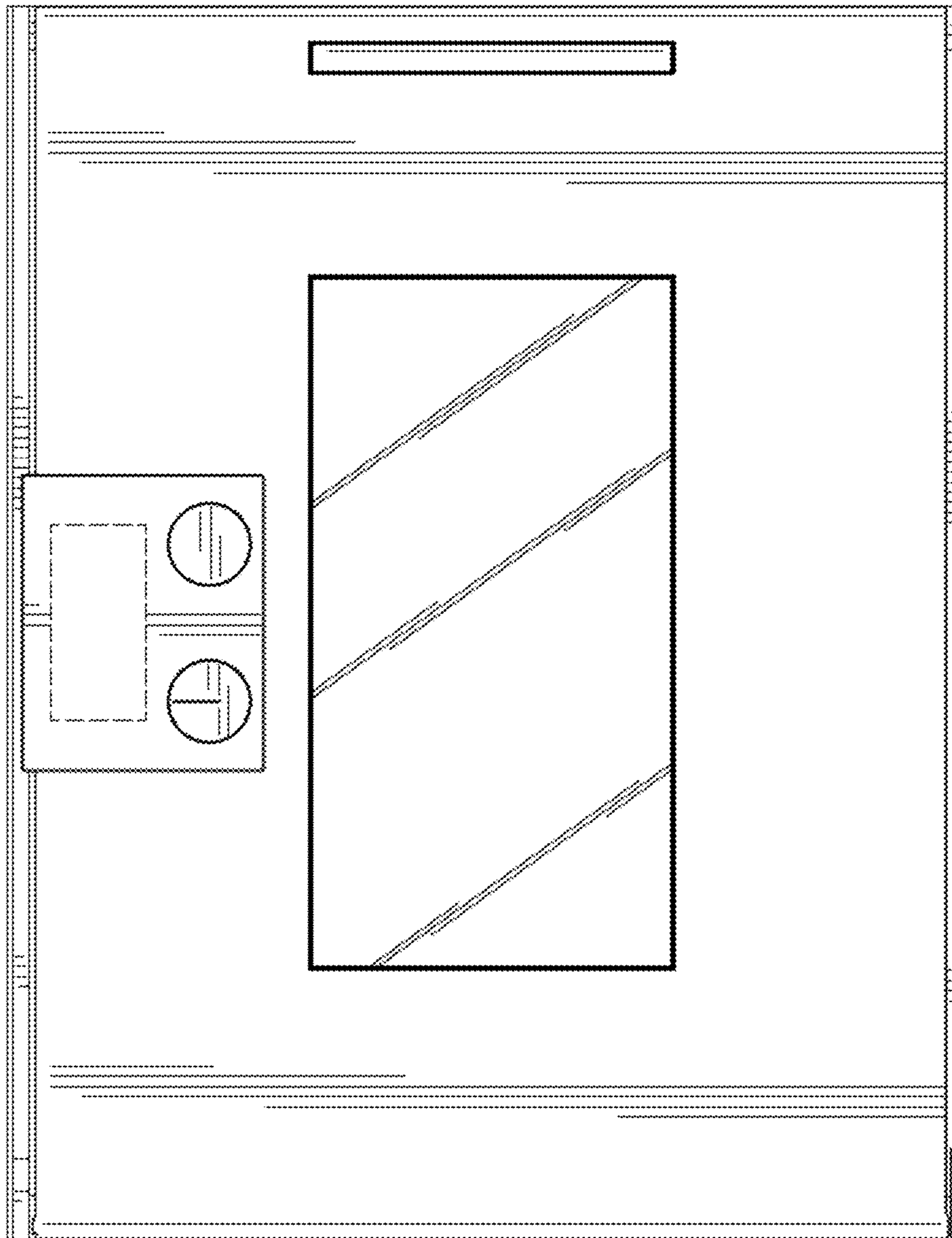
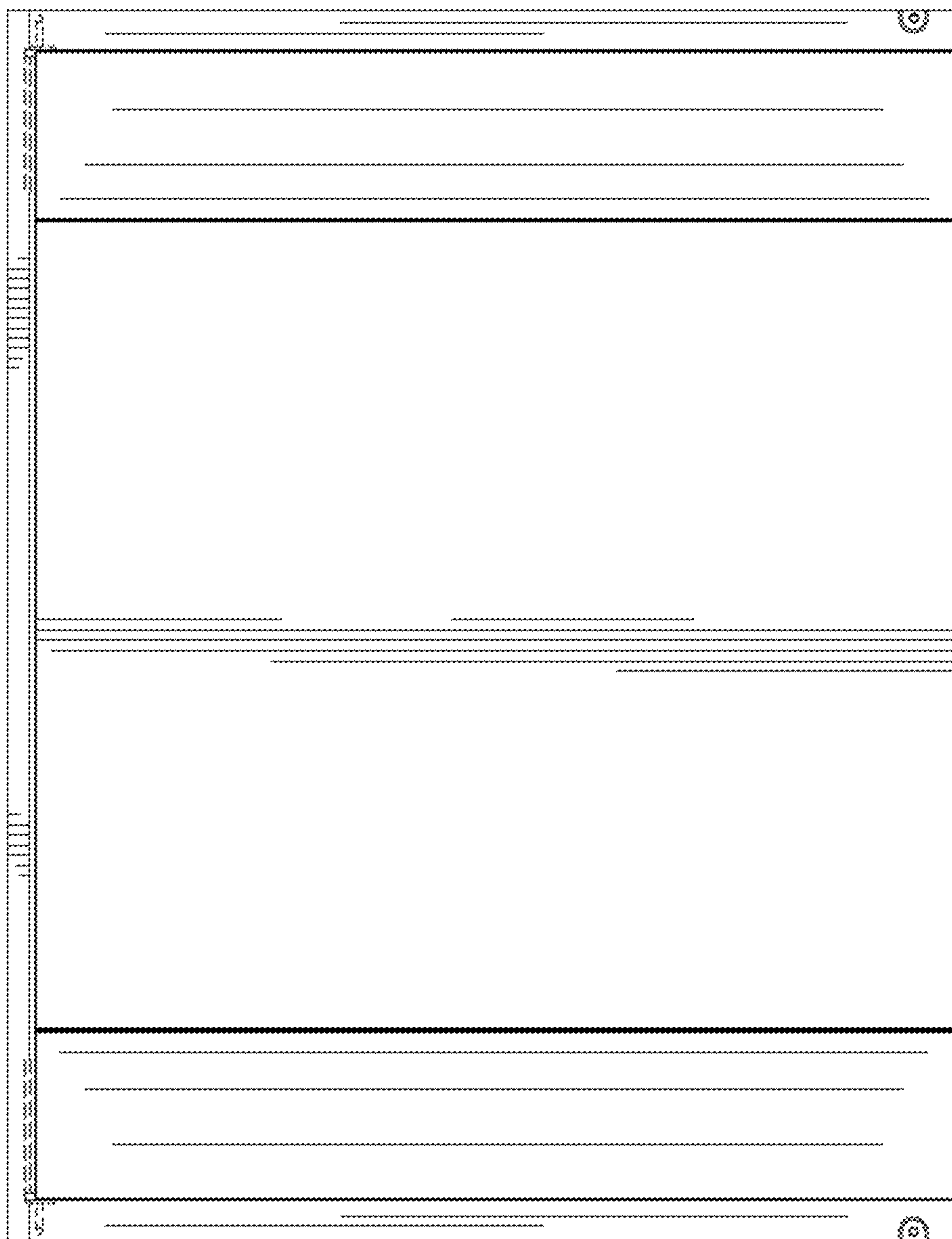

FIG. 10



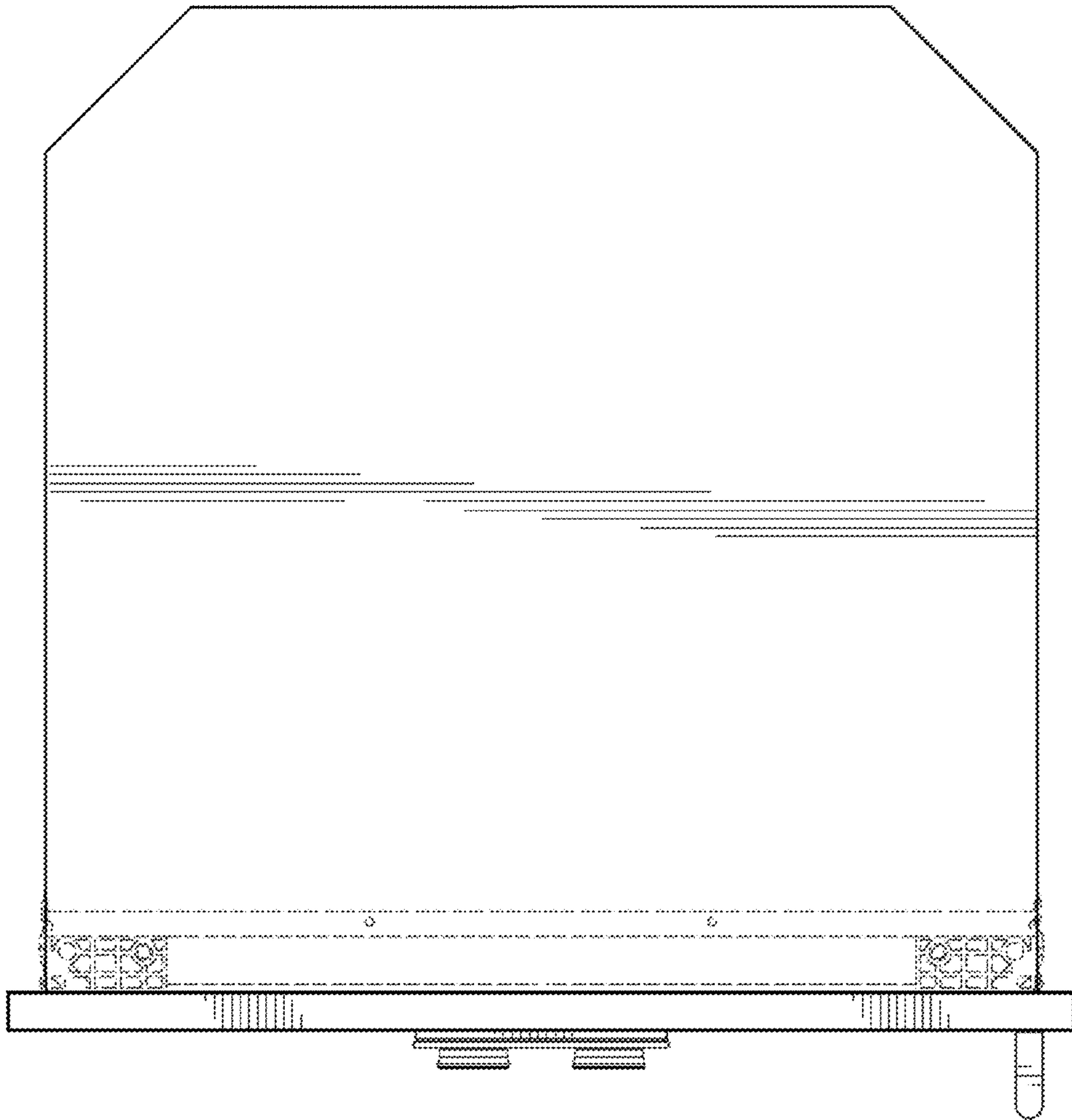

FIG. 11

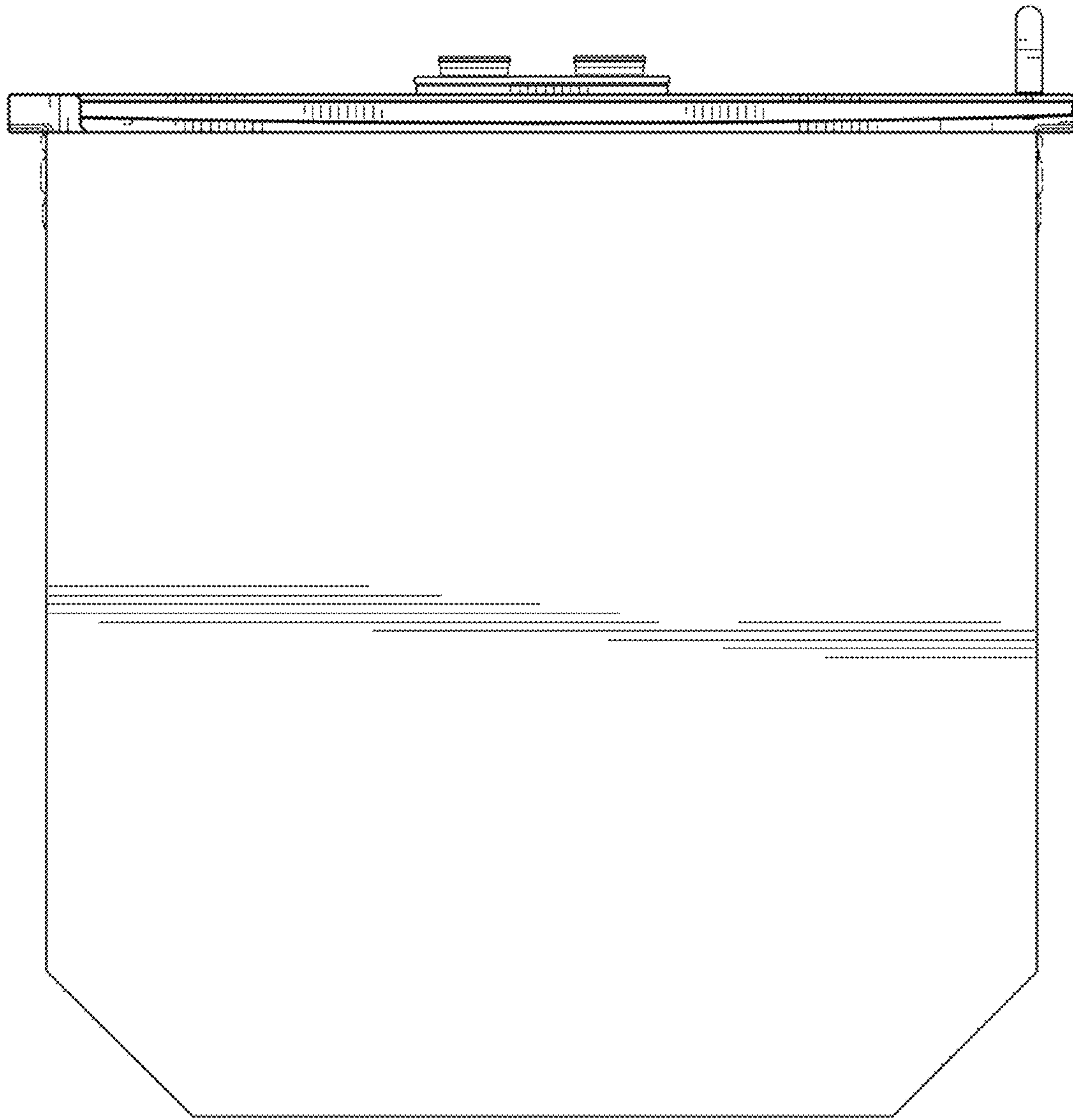

FIG. 12



FIG. 13

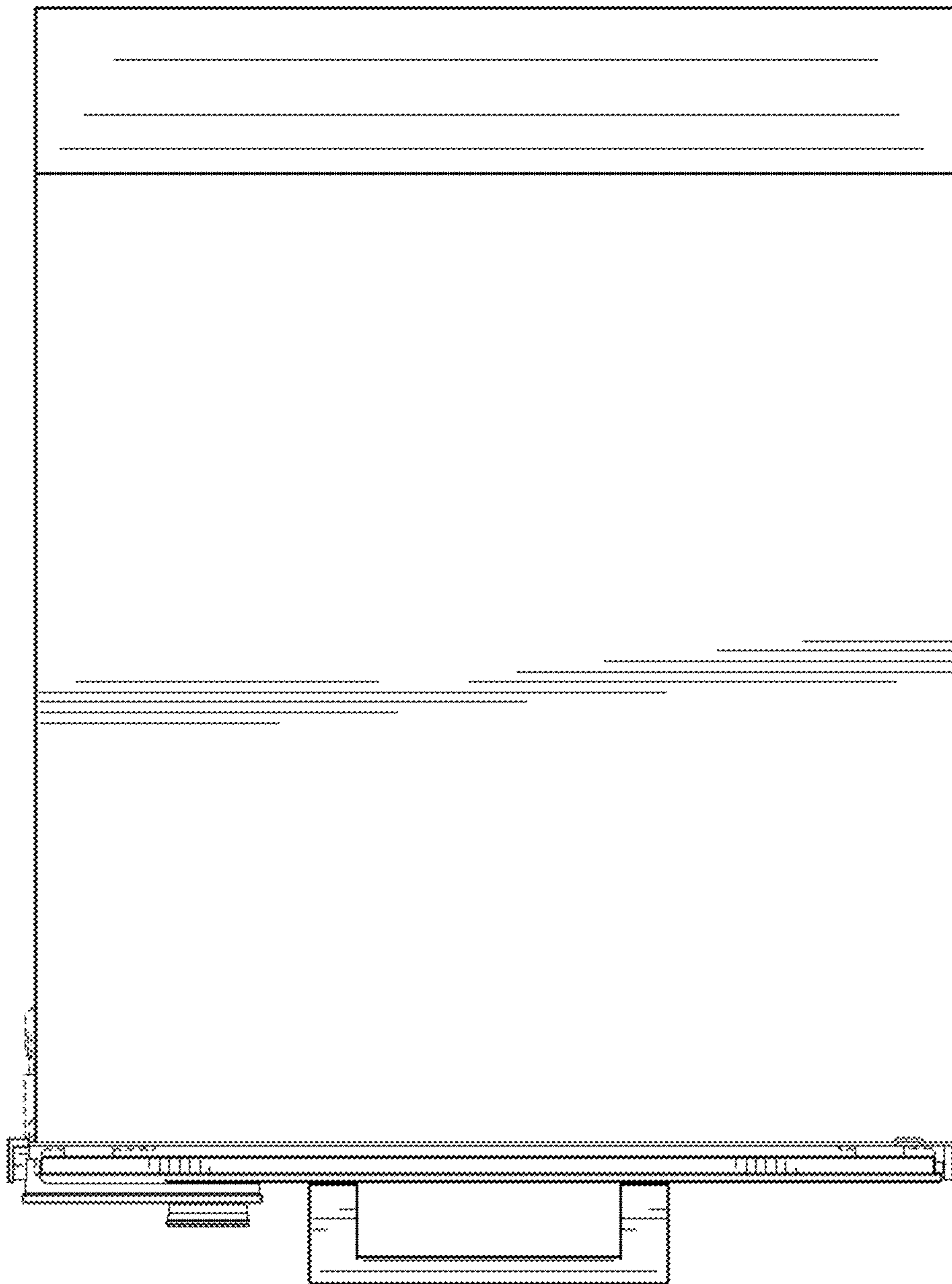
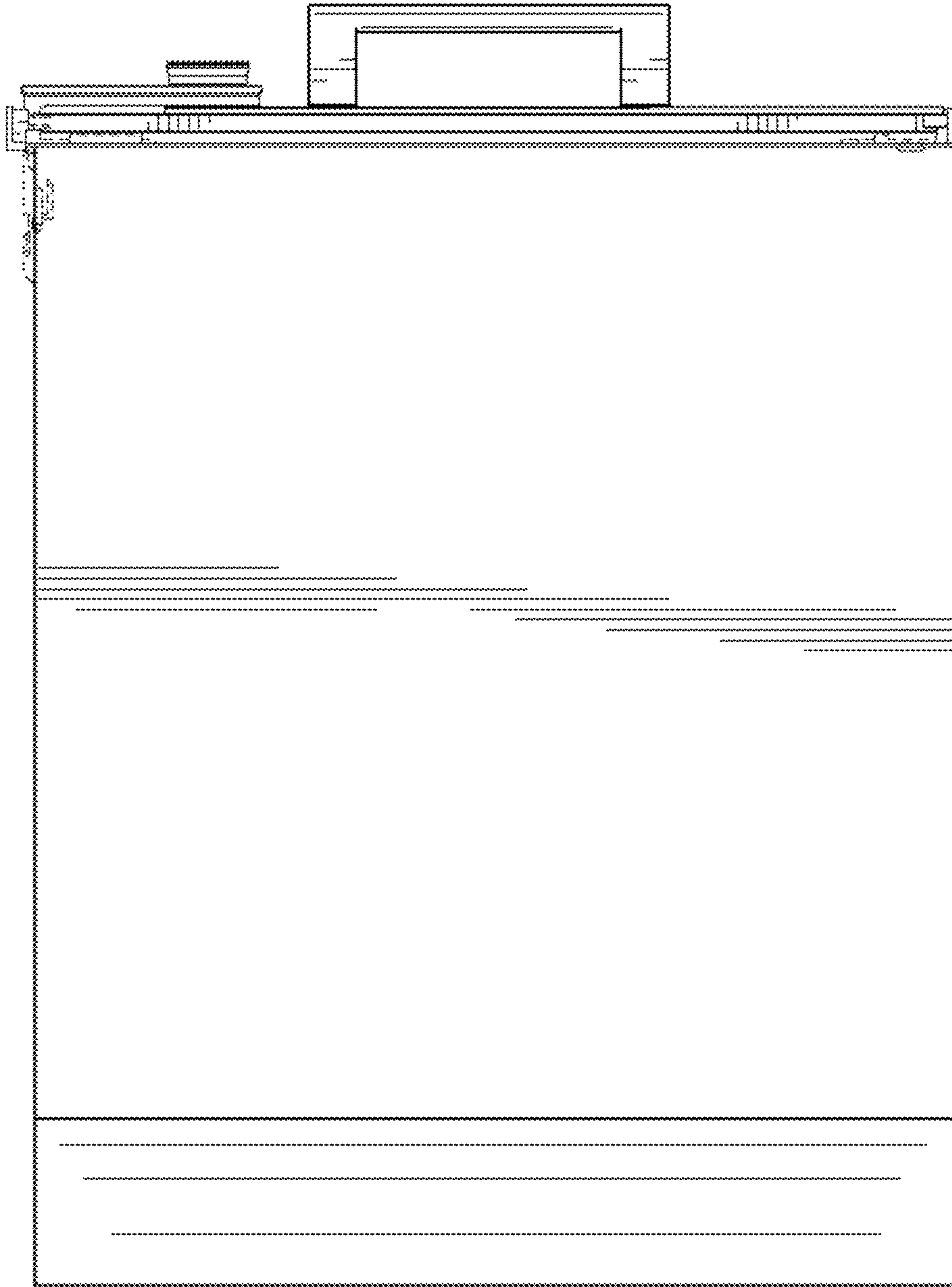

FIG. 14



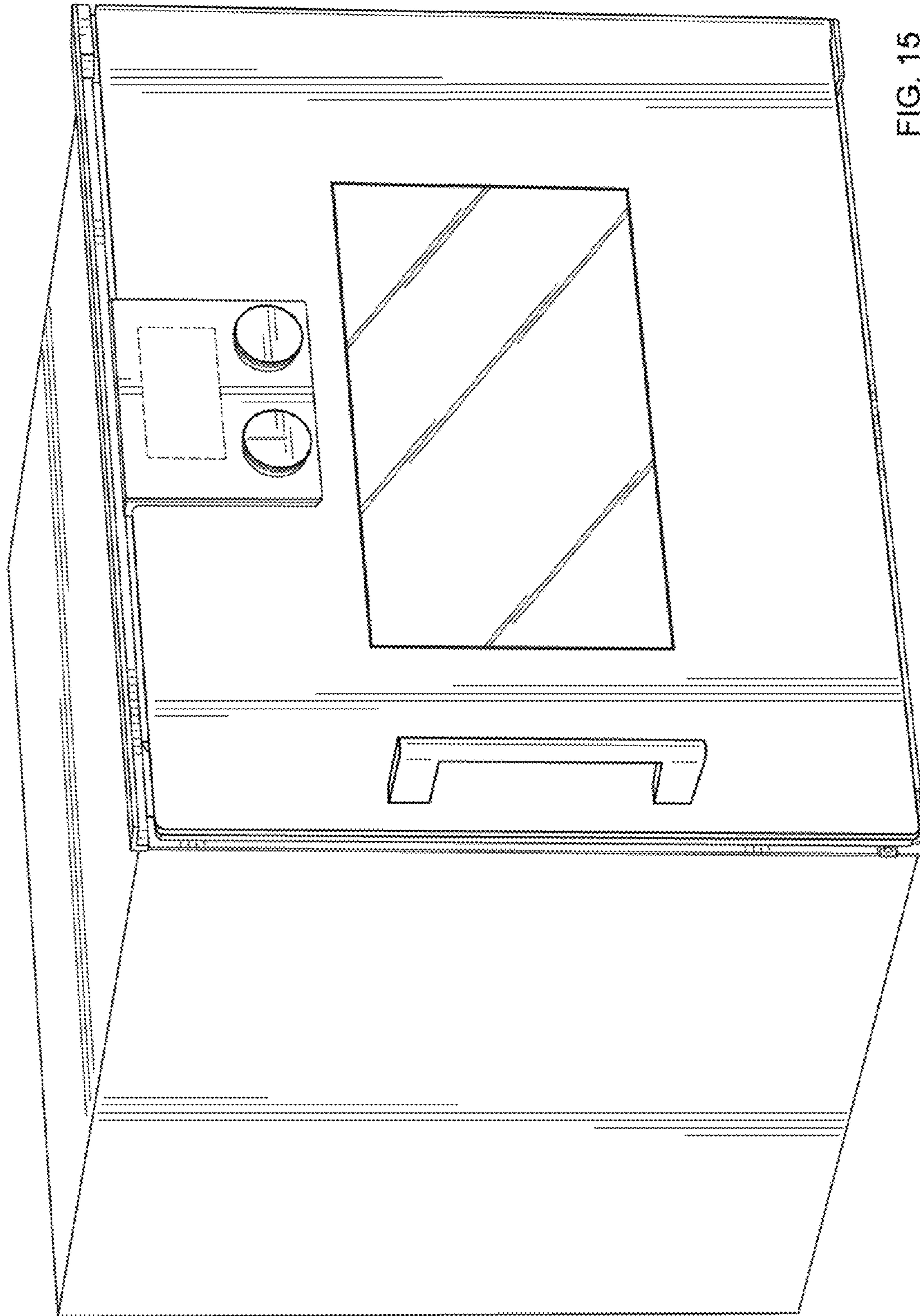

FIG. 15

FIG. 16

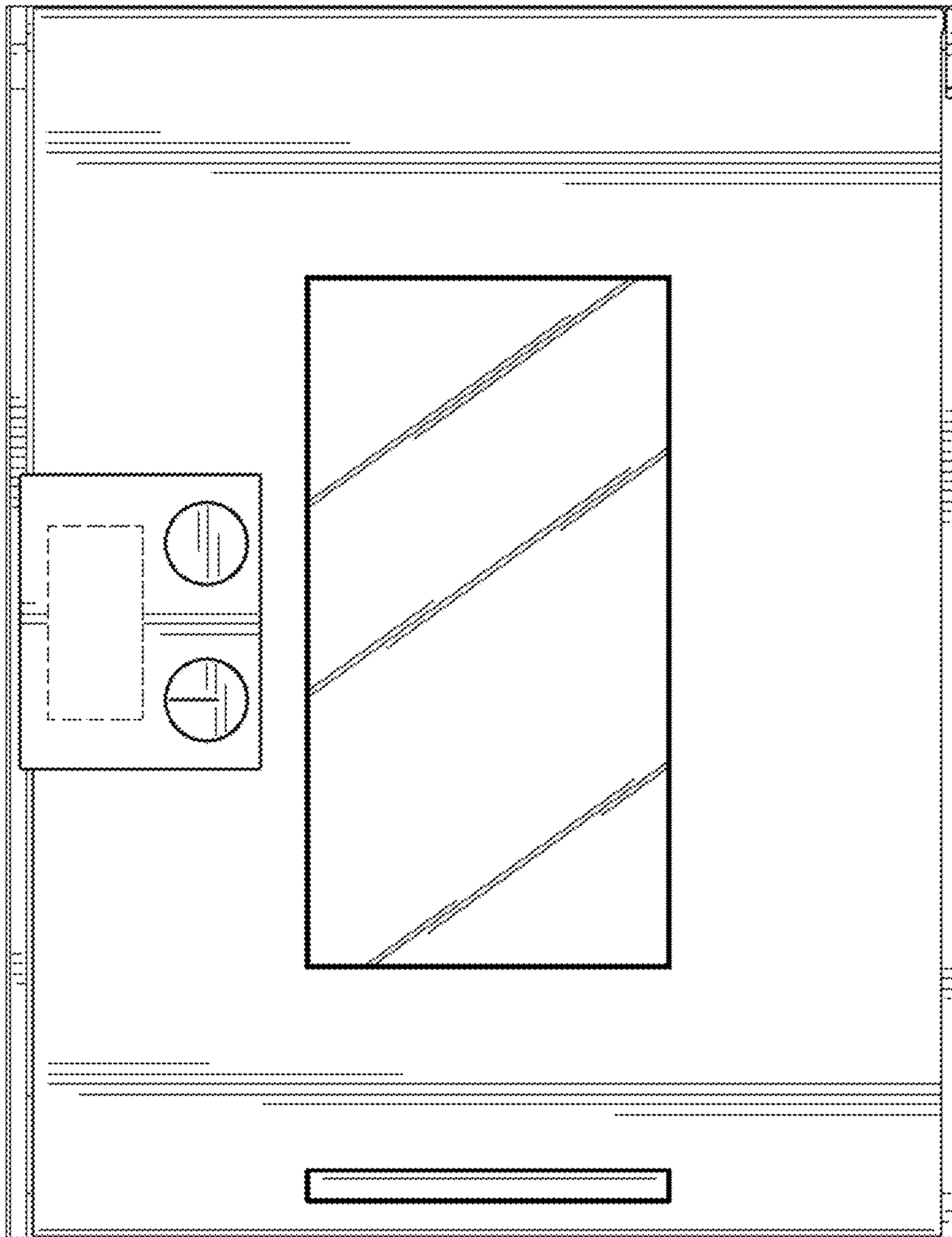
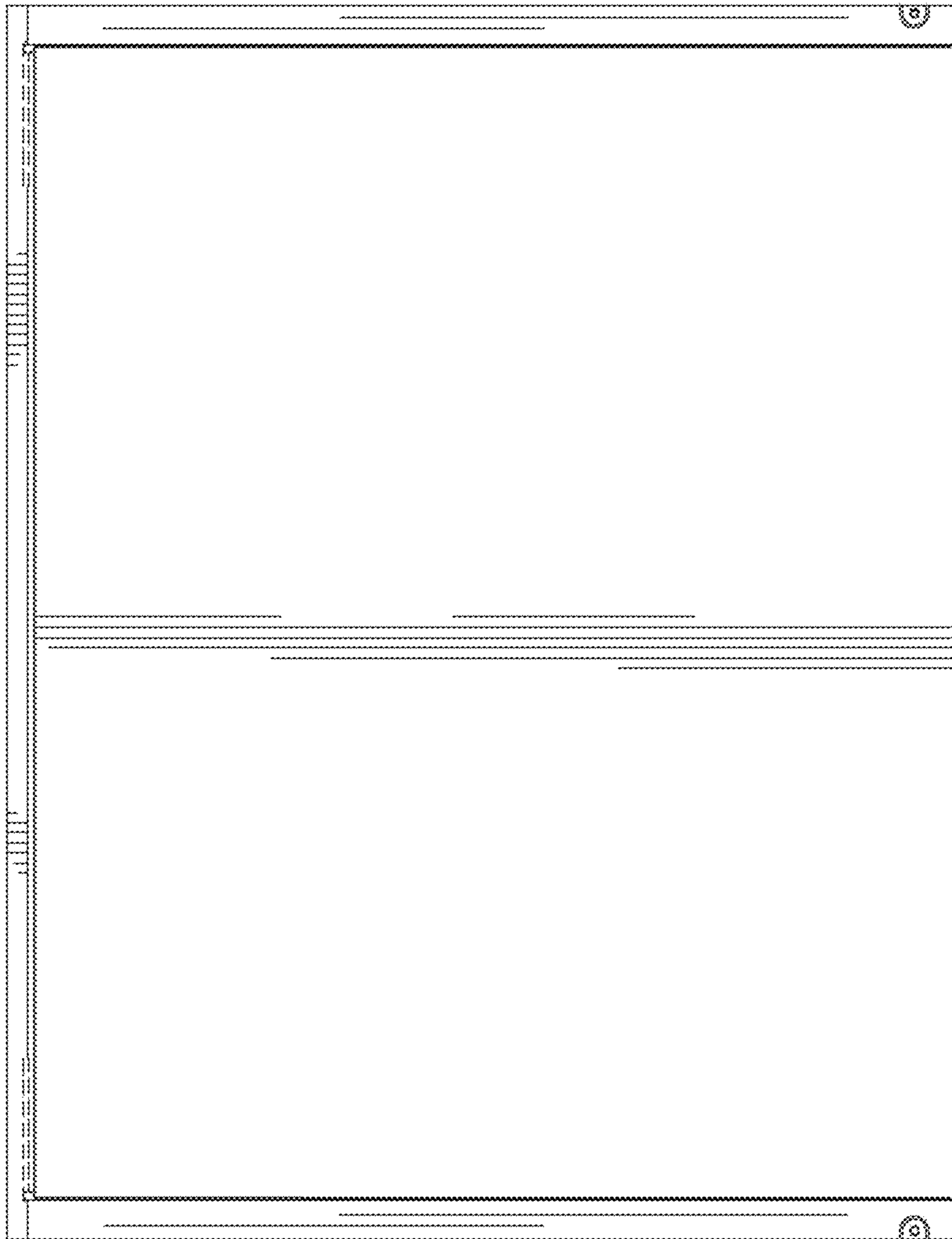

FIG. 17





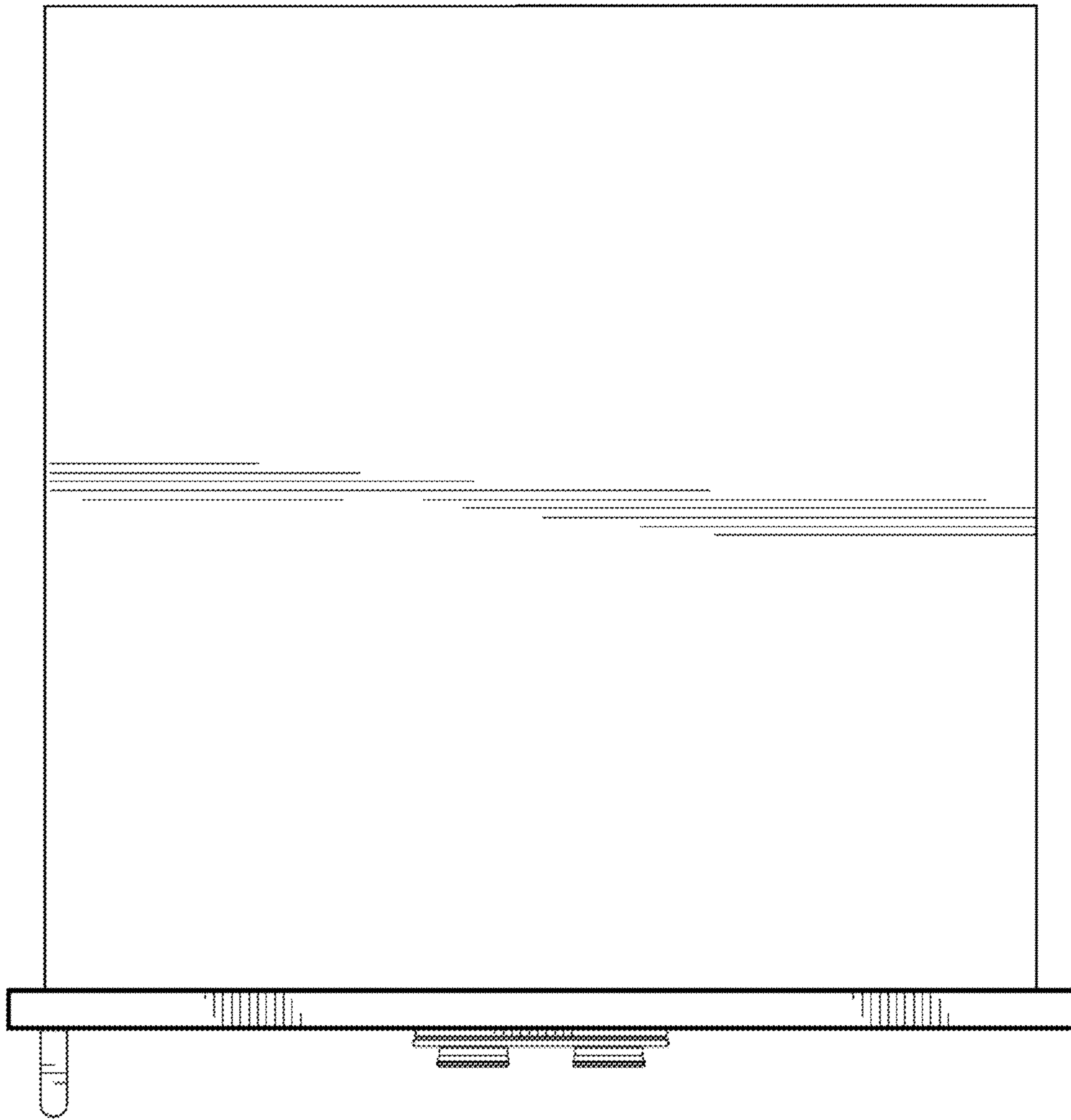

FIG. 18

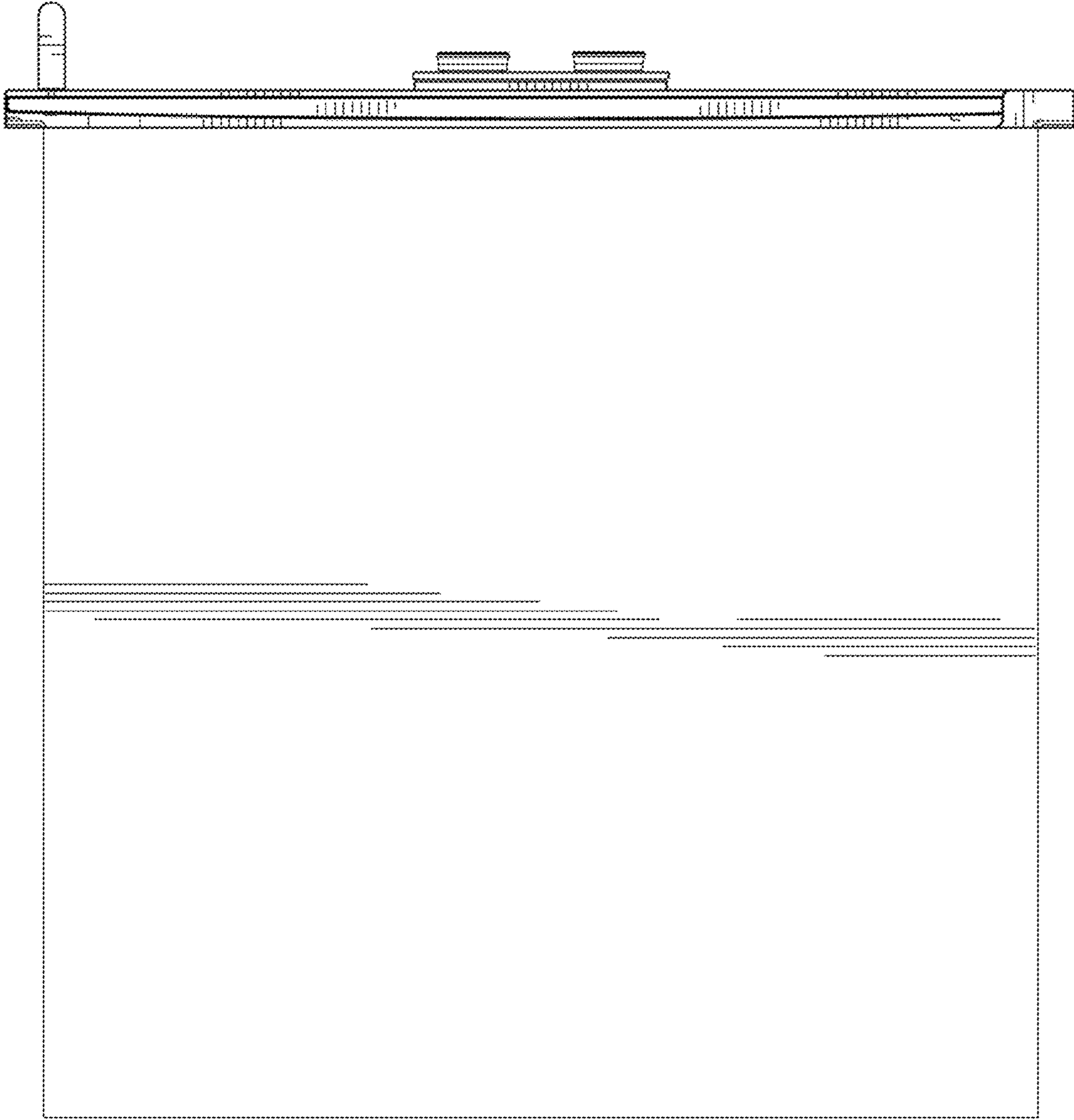

FIG. 19

FIG. 20

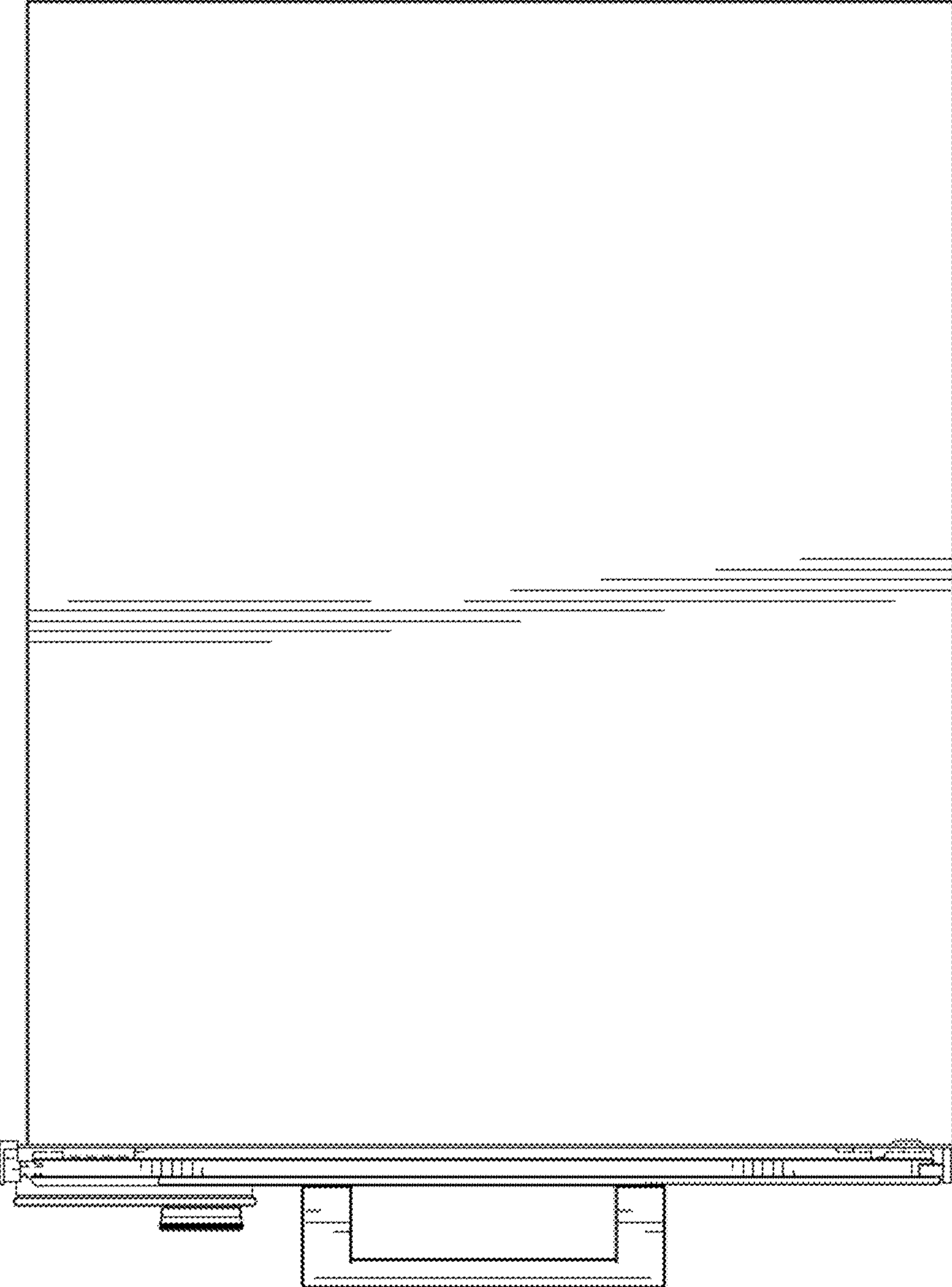
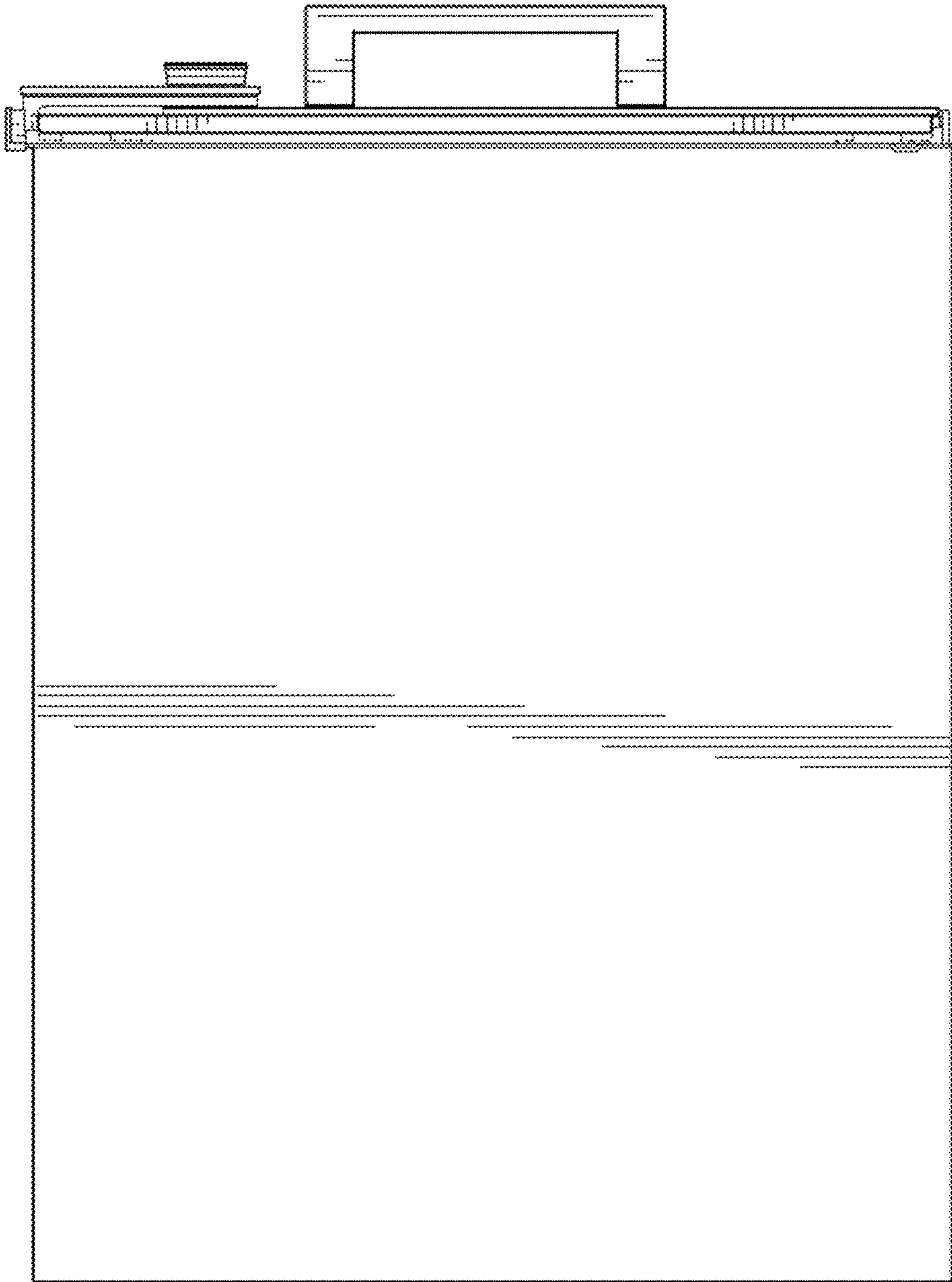

FIG. 21



UNITED STATES PATENT AND TRADEMARK OFFICE  
**CERTIFICATE OF CORRECTION**

PATENT NO. : D736,028 S  
APPLICATION NO. : 29/445436  
DATED : August 11, 2015  
INVENTOR(S) : Sven Baacke et al.

Page 1 of 1

It is certified that error appears in the above-identified patent and that said Letters Patent is hereby corrected as shown below:

On the title page item (73), include

BSH Hausgeraete GmbH, Munich (DE)

Signed and Sealed this  
Eighth Day of March, 2016



Michelle K. Lee  
*Director of the United States Patent and Trademark Office*