



US00D736008S

(12) **United States Design Patent**
Bosman et al.

(10) **Patent No.:** **US D736,008 S**

(45) **Date of Patent:** **** Aug. 11, 2015**

(54) **LOUNGE CHAIR**

(71) Applicant: **Krueger International, Inc.**, Green Bay, WI (US)

(72) Inventors: **Scott A. Bosman**, Green Bay, WI (US); **Tad E. Lenhart**, DePere, WI (US); **Scott J. Williams**, Green Bay, WI (US)

(73) Assignee: **Krueger International, Inc.**, Green Bay, WI (US)

(**) Term: **14 Years**

(21) Appl. No.: **29/520,807**

(22) Filed: **Mar. 18, 2015**

(51) **LOC (10) Cl.** **06-01**

(52) **U.S. Cl.**
USPC **D6/375**

(58) **Field of Classification Search**
USPC D6/334-336, 364, 365, 366, 374, 375, D6/716, 716.1, 716.4
CPC A47C 4/02; A47C 4/03; A47C 7/16; A47C 5/12; A47C 3/12; A47C 5/06; A47C 7/02
See application file for complete search history.

(56) **References Cited**

U.S. PATENT DOCUMENTS

2,764,228 A * 9/1956 Donohue A47C 5/12
D196,719 S * 10/1963 Johnson D6/366
D200,533 S * 3/1965 Hopkins D6/364
D211,170 S 5/1968 Carsello
3,393,941 A * 7/1968 Grosfillex A47C 5/06
D222,745 S * 12/1971 Bernard D6/364
D224,867 S * 10/1972 Burke D6/375

D225,933 S * 1/1973 Duern et al. D6/374
3,827,750 A * 8/1974 Fantoni A47C 7/02
4,294,426 A 10/1981 Fleischer
D330,461 S * 10/1992 Stevens D6/374
D348,361 S 7/1994 Beecher
D420,520 S 2/2000 Johnston
6,176,548 B1 1/2001 Thole et al.
D503,047 S * 3/2005 Ryan D6/365
7,140,685 B2 11/2006 Gardner
7,575,276 B1 8/2009 Henry
2009/0188410 A1 7/2009 Billich

FOREIGN PATENT DOCUMENTS

EP 2 568 852 B1 6/2014

* cited by examiner

Primary Examiner — Mimoso De

(74) *Attorney, Agent, or Firm* — Andrus Intellectual Property Law, LLP

(57) **CLAIM**

The ornamental design for a lounge chair, as shown and described.

DESCRIPTION

FIG. 1 is an isometric view of a lounge chair; FIG. 2 is a front elevation view thereof; FIG. 3 is a back elevation view thereof; FIG. 4 is a right side elevation view thereof; FIG. 5 is a left side elevation view thereof; FIG. 6 is a top plan view thereof; and, FIG. 7 is a bottom plan view thereof. The broken lines shown in the drawing Figures are meant to indicate environment only and form no part of the claimed design.

1 Claim, 4 Drawing Sheets

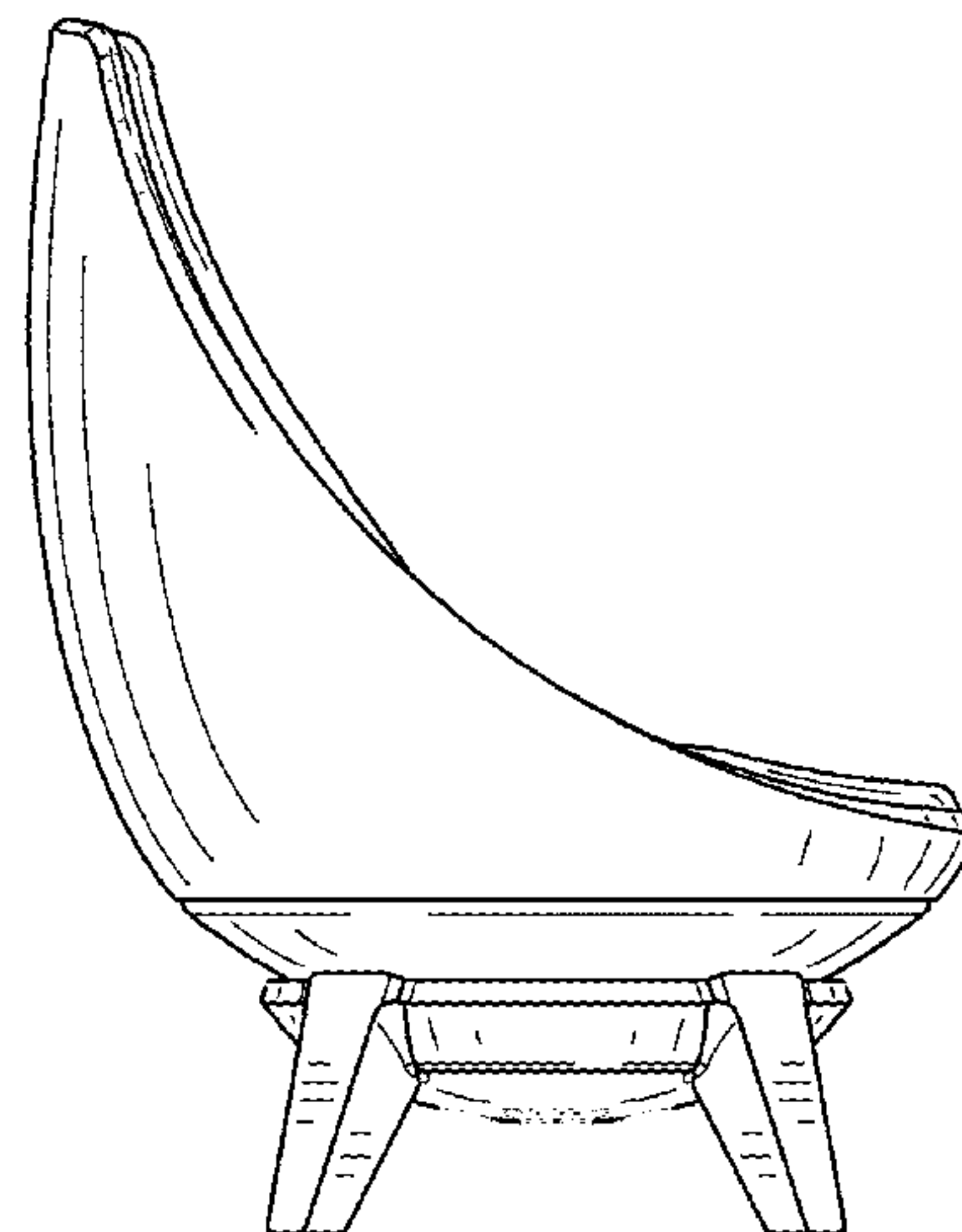
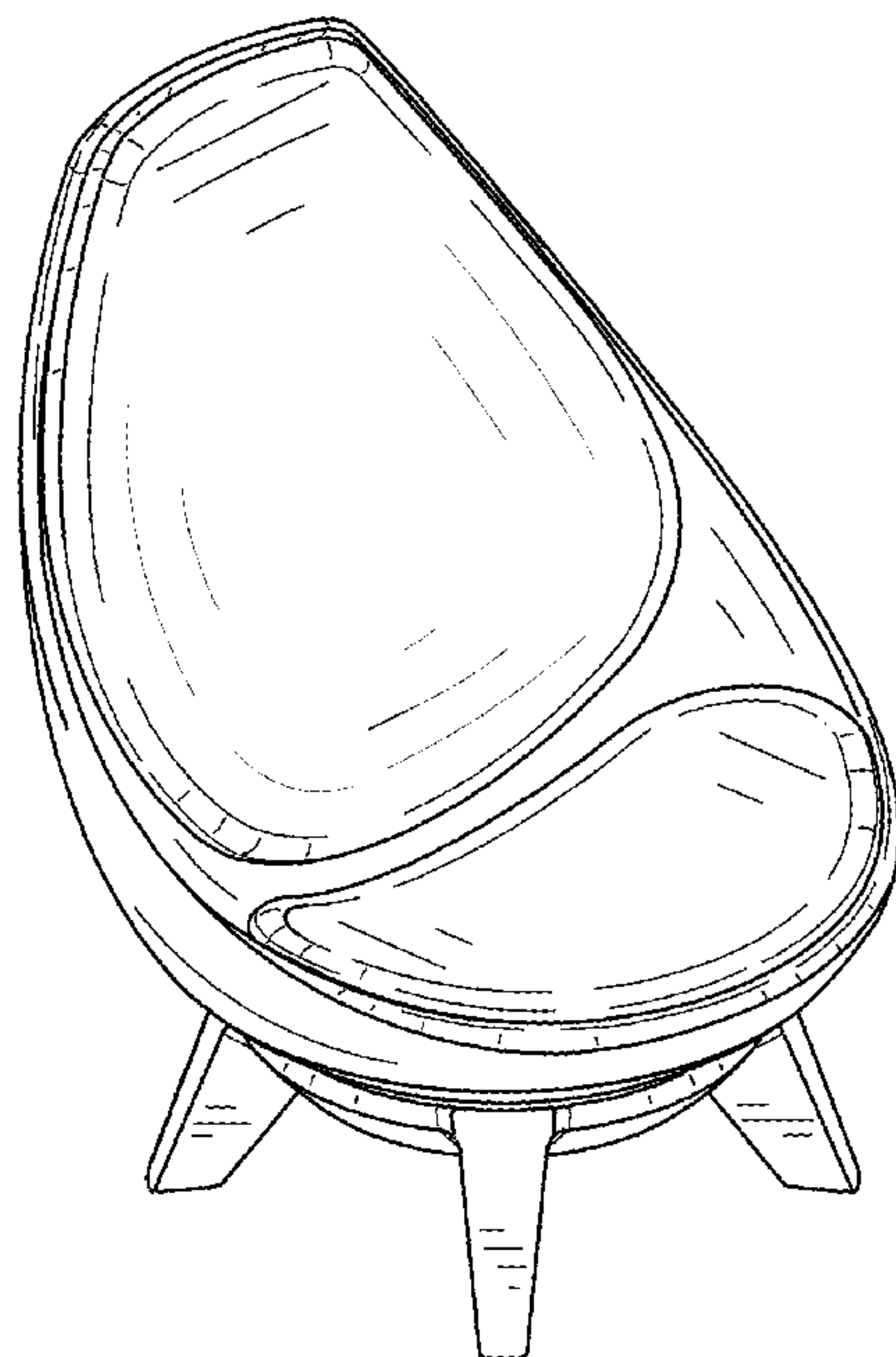

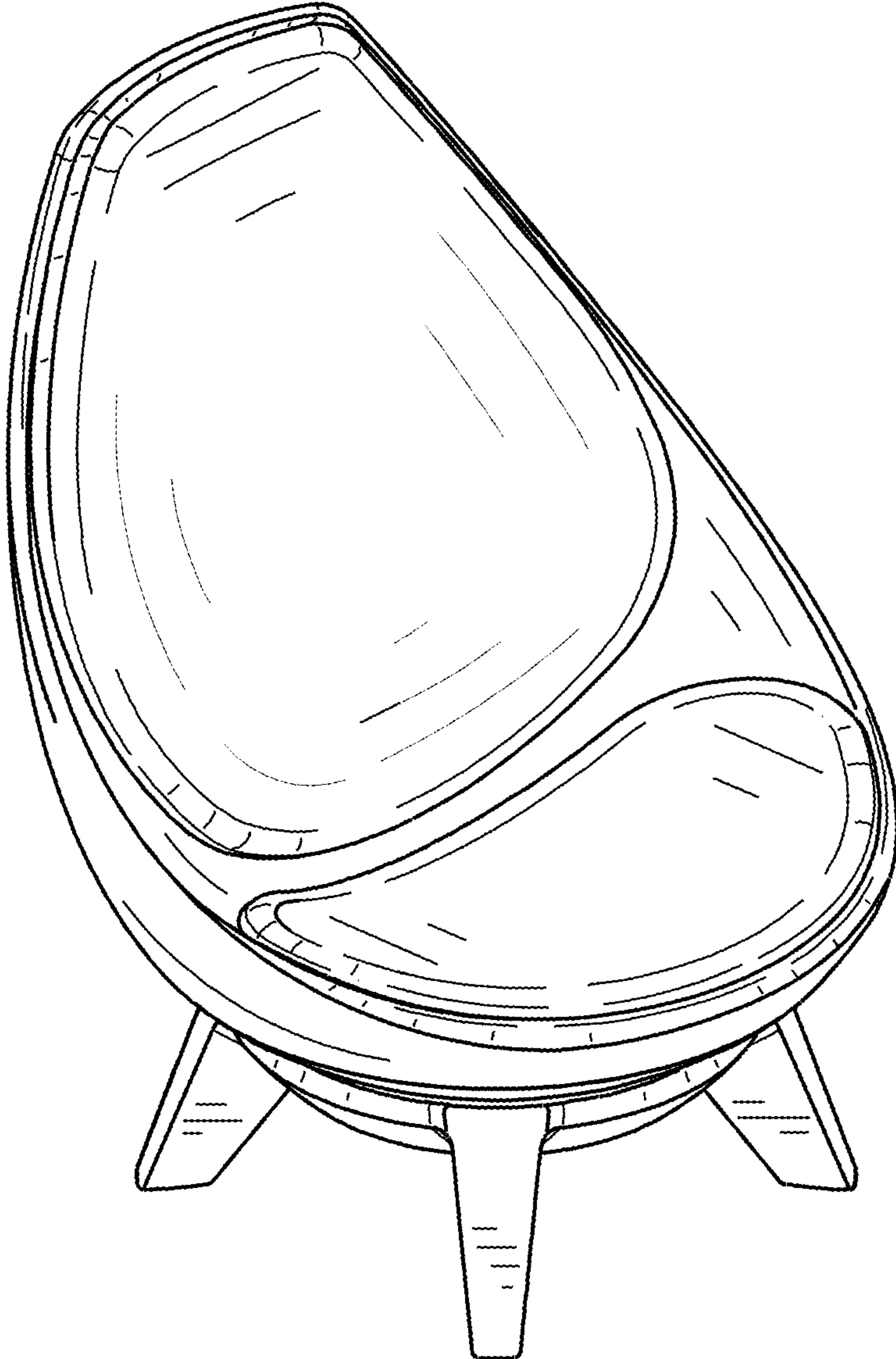

FIG. 1

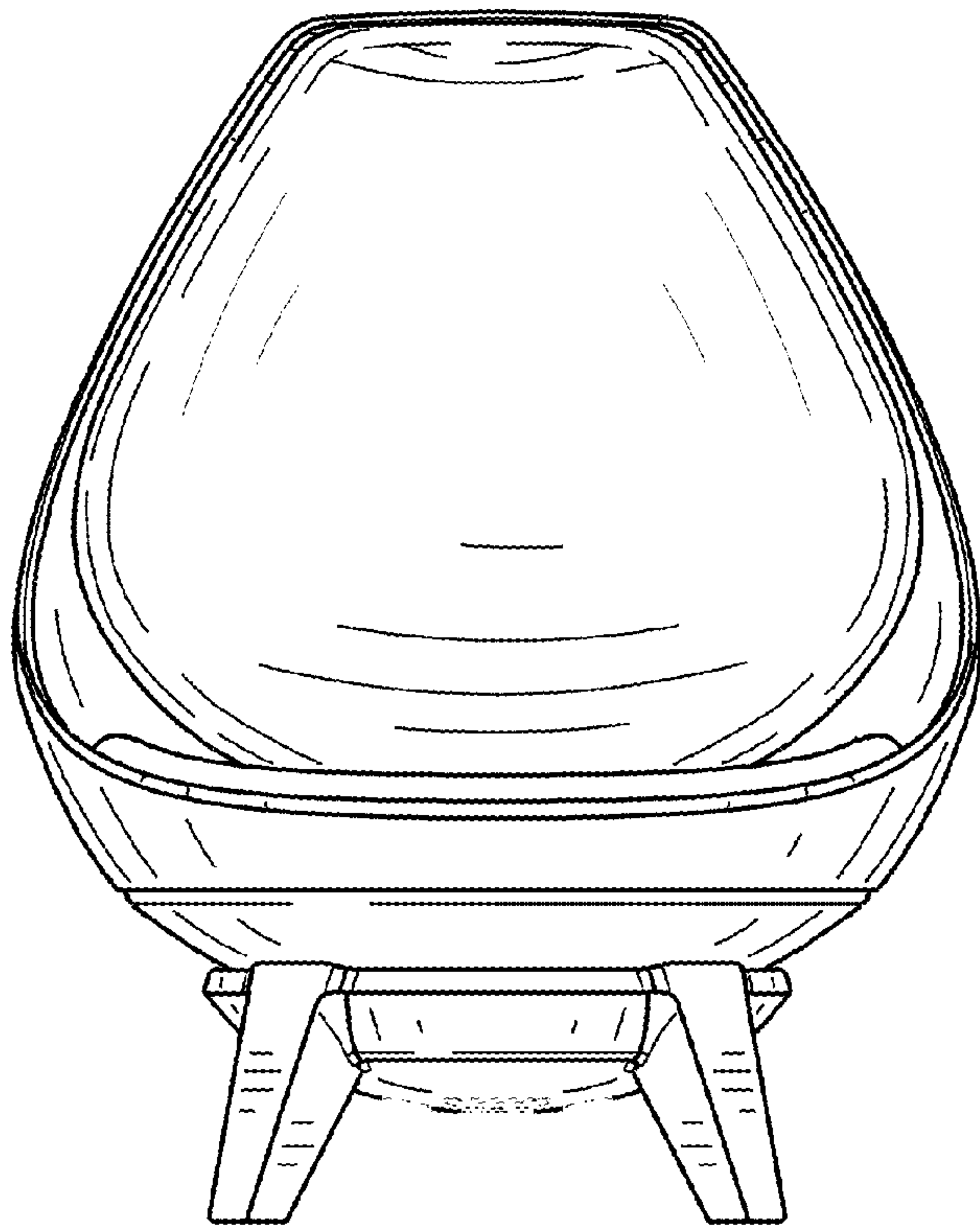

FIG. 2

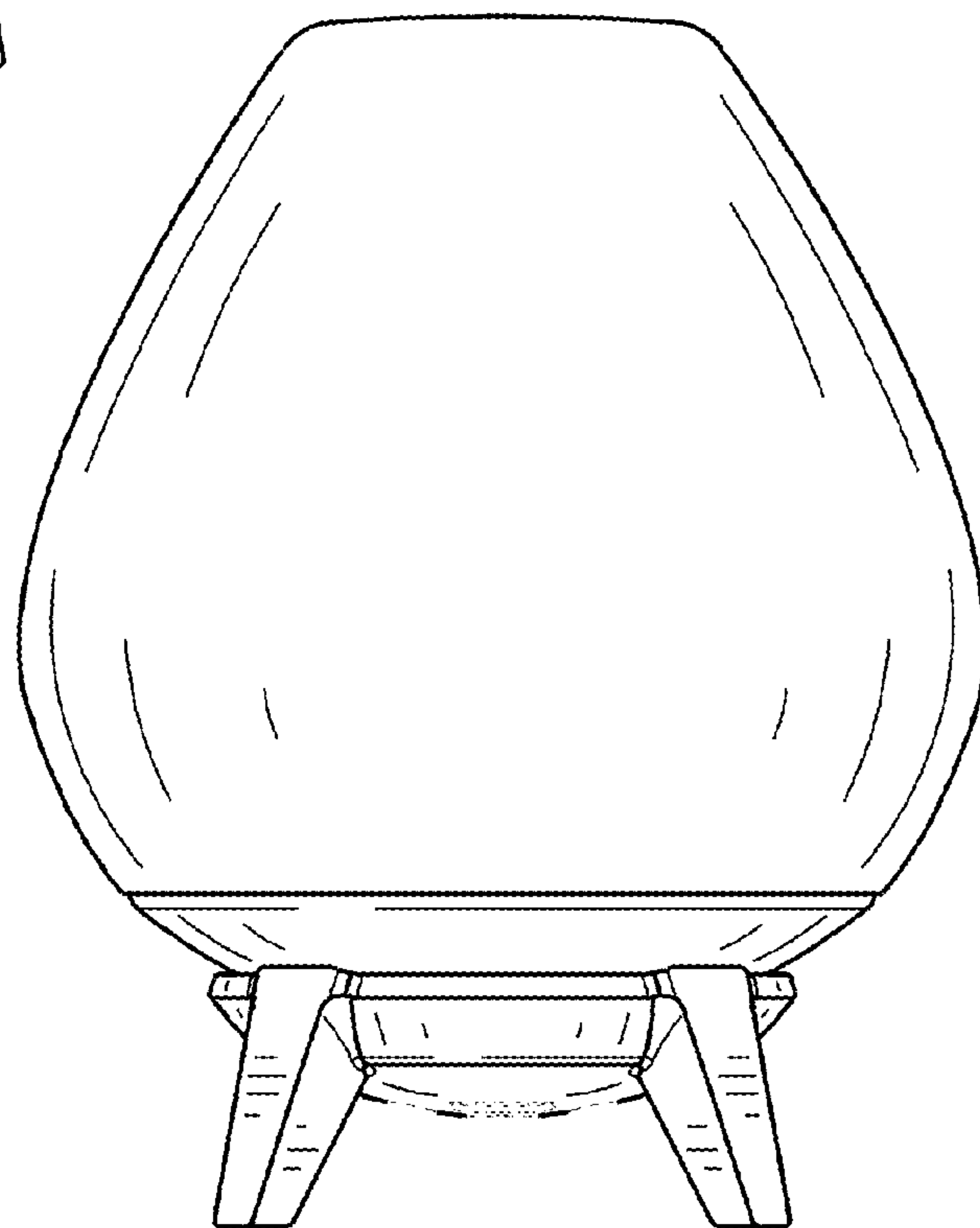

FIG. 3

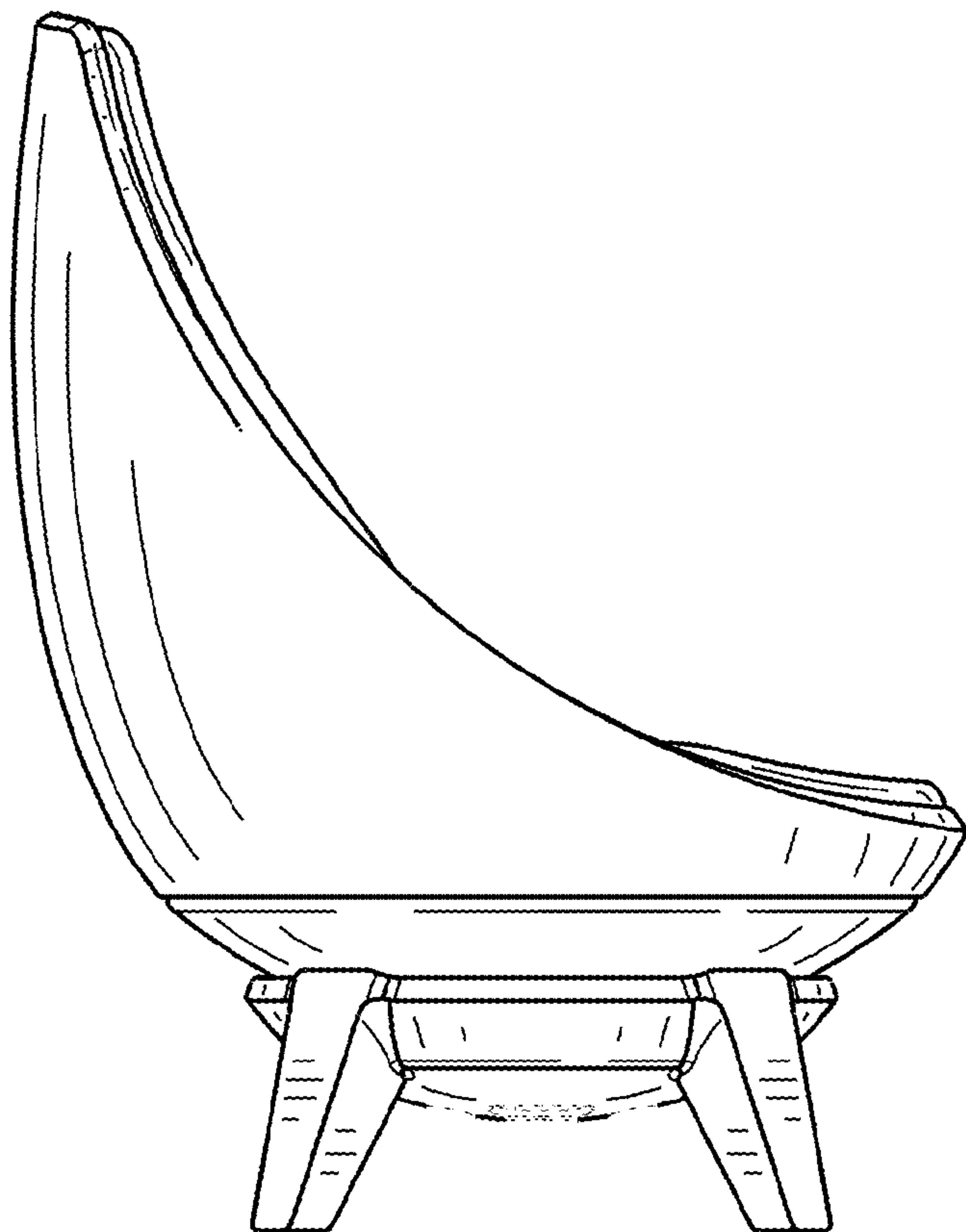

FIG. 4

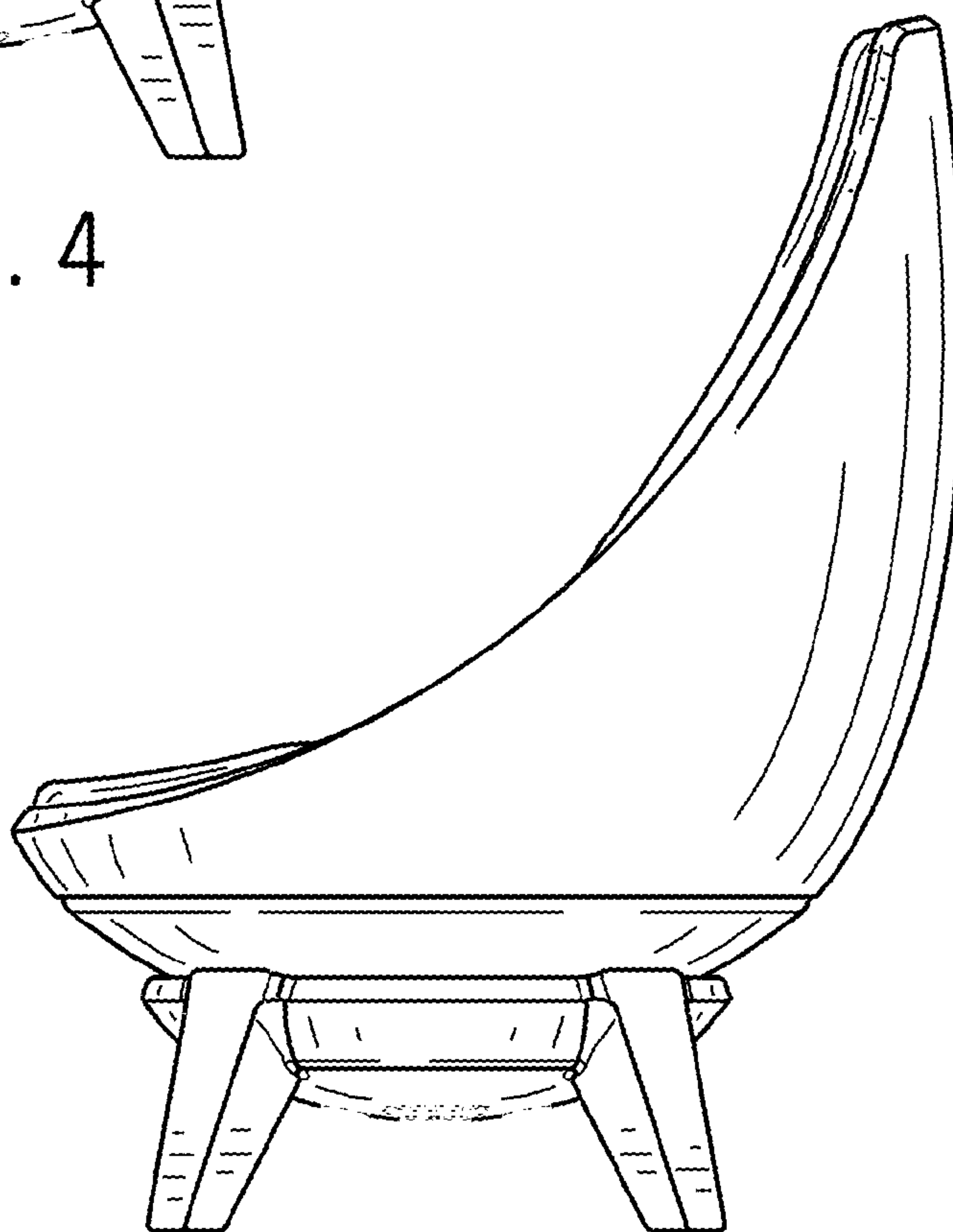

FIG. 5

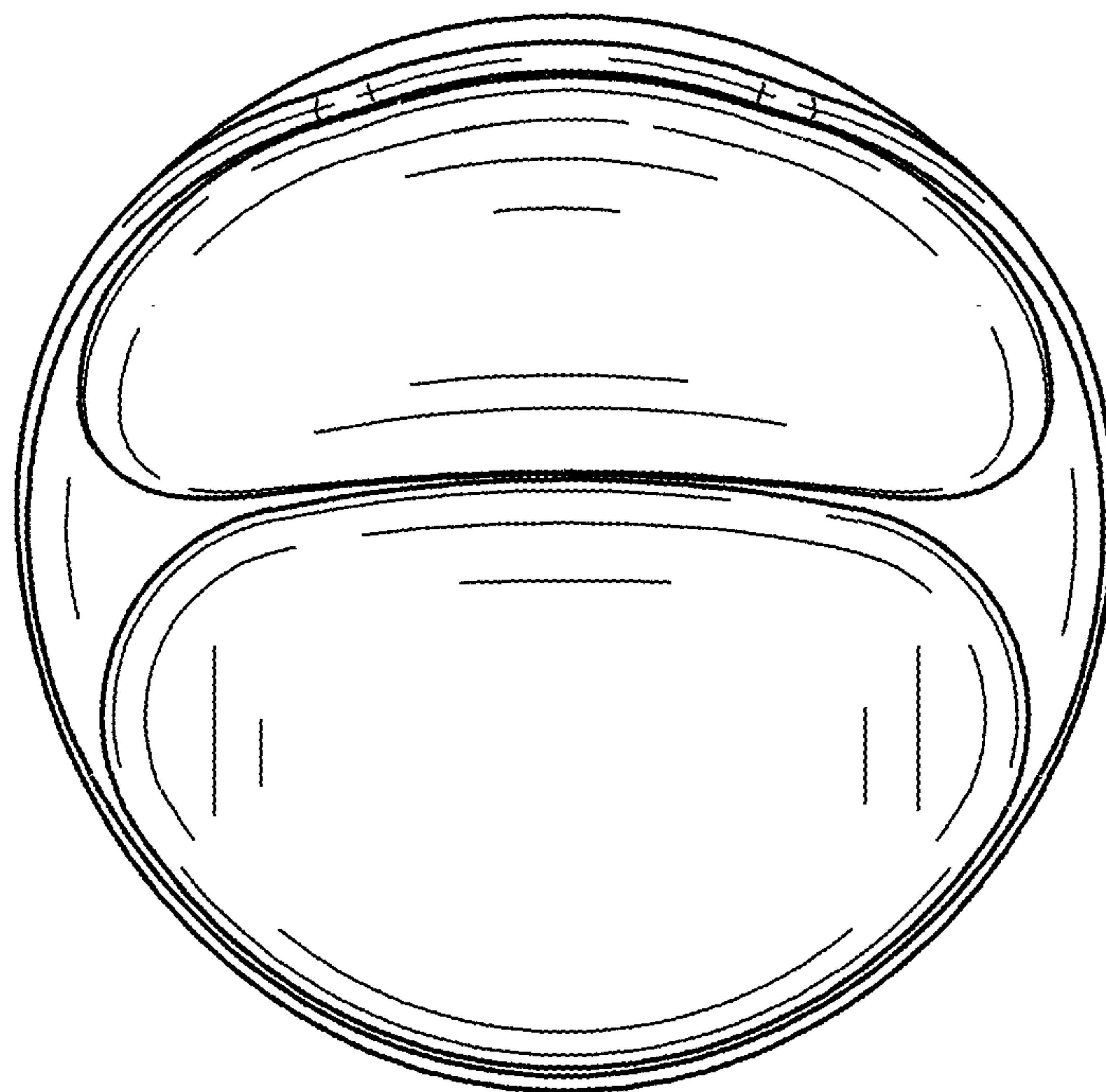

FIG. 6

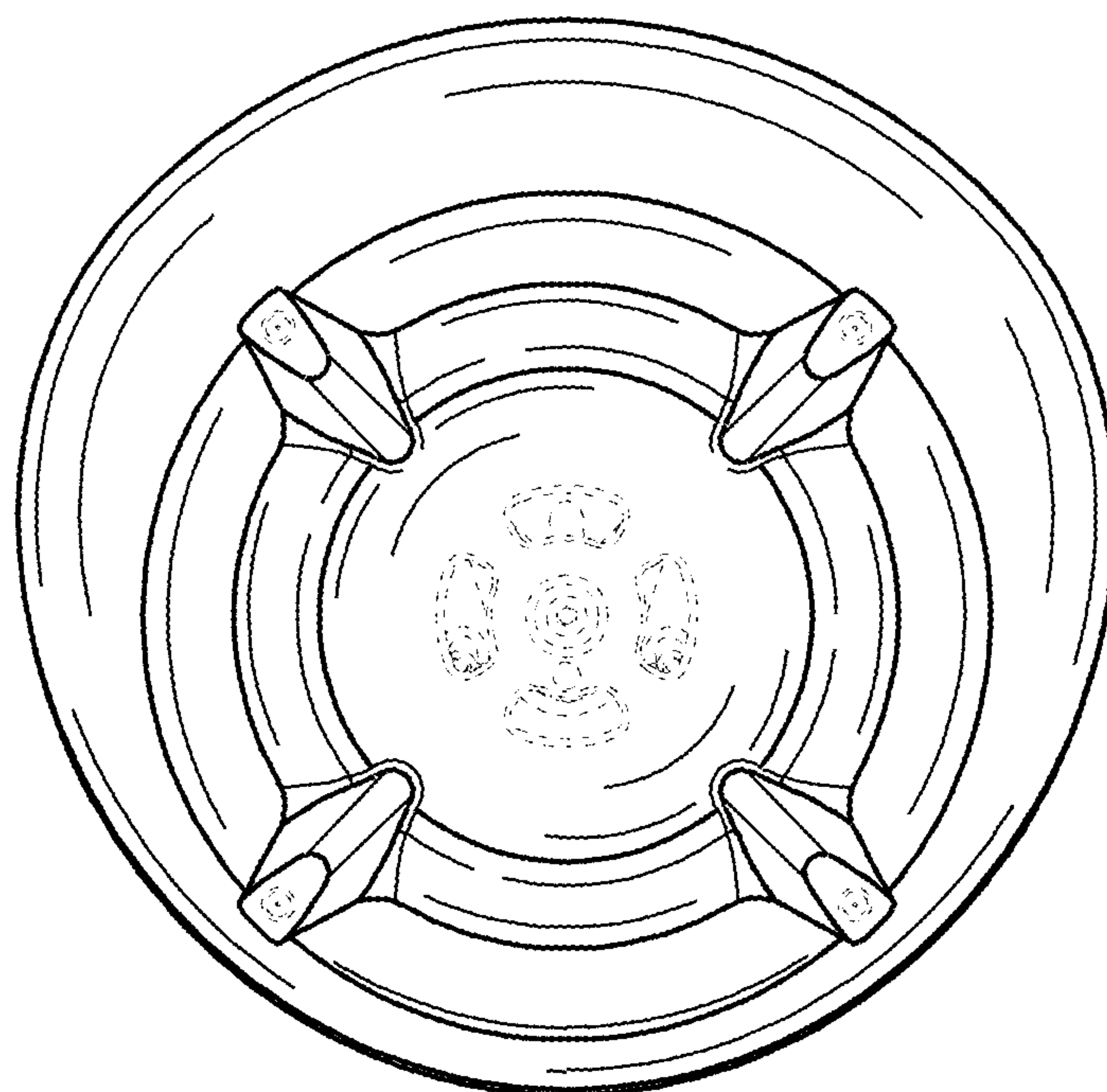

FIG. 7