



US00D735947S

(12) **United States Design Patent**
Reyes et al.

(10) **Patent No.:** **US D735,947 S**
(45) **Date of Patent:** **** Aug. 4, 2015**

- (54) **COSMETIC COMPACT**
- (71) Applicants: **Paulina Reyes**, New York, NY (US);
Michael Kaye, New York, NY (US)
- (72) Inventors: **Paulina Reyes**, New York, NY (US);
Michael Kaye, New York, NY (US)
- (73) Assignee: **Revlon Consumer Products Corporation**, New York, NY (US)
- (**) Term: **14 Years**
- (21) Appl. No.: **29/470,853**
- (22) Filed: **Oct. 25, 2013**
- (51) **LOC (10) Cl.** **28-03**
- (52) **U.S. Cl.**
USPC **D28/79**; D28/82
- (58) **Field of Classification Search**
USPC D28/64.1-64.7, 76-84; 206/581, 823;
132/286-318; D9/503-505, 421, 428,
D9/447; D3/901; 220/4.27
CPC A45D 33/006; A45D 33/003; A45D
33/04-33/16; A45D 33/025; A45D 33/02;
A45D 33/20; A45D 33/22; A45D 33/24;
A45D 33/26; A45D 33/28; A45D 33/18;
A45D 40/22; A45D 40/222; A45D 40/24;
A45D 42/02
See application file for complete search history.

- D333,917 S * 3/1993 Daido et al. D3/294
- D363,661 S * 10/1995 Lambelet et al. D3/203.4
- 6,041,935 A * 3/2000 Yang 206/581
- D424,751 S * 5/2000 Kudo et al. D28/78
- D482,278 S * 11/2003 Westphal D9/428
- D583,100 S * 12/2008 Jackel D28/82
- D583,505 S * 12/2008 Jackel D28/82
- D648,626 S * 11/2011 Oates et al. D9/449

OTHER PUBLICATIONS

Web Image of Nuance Salma Hayek Compact, Jan. 11, 2012, one page.*

* cited by examiner

Primary Examiner — Jennifer Rivard

(74) *Attorney, Agent, or Firm* — Revlon Consumer Products Corporation

(57) **CLAIM**

The ornamental design for a cosmetic compact, as shown and described.

DESCRIPTION

FIG. 1 is a top view of a cosmetic compact in accordance with the present design.
 FIG. 2 is a bottom view of a cosmetic compact.
 FIG. 3 is a front view of a cosmetic compact.
 FIG. 4 is a back view of a cosmetic compact.
 FIG. 5 is a right side view of a cosmetic compact.
 FIG. 6 is a left side view of a cosmetic compact.
 FIG. 7 is a top perspective view of a cosmetic compact; and,
 FIG. 8 is a top perspective view of the cosmetic compact shown in FIG. 7 with an opened cover.
 The broken lines shown in the drawings illustrate portions of the compact and form no part of the claimed design.

1 Claim, 4 Drawing Sheets

- (56) **References Cited**
U.S. PATENT DOCUMENTS
2,537,534 A * 1/1951 Landry 132/297
D286,331 S * 10/1986 Scoccola D28/78
D332,398 S 1/1993 Lee

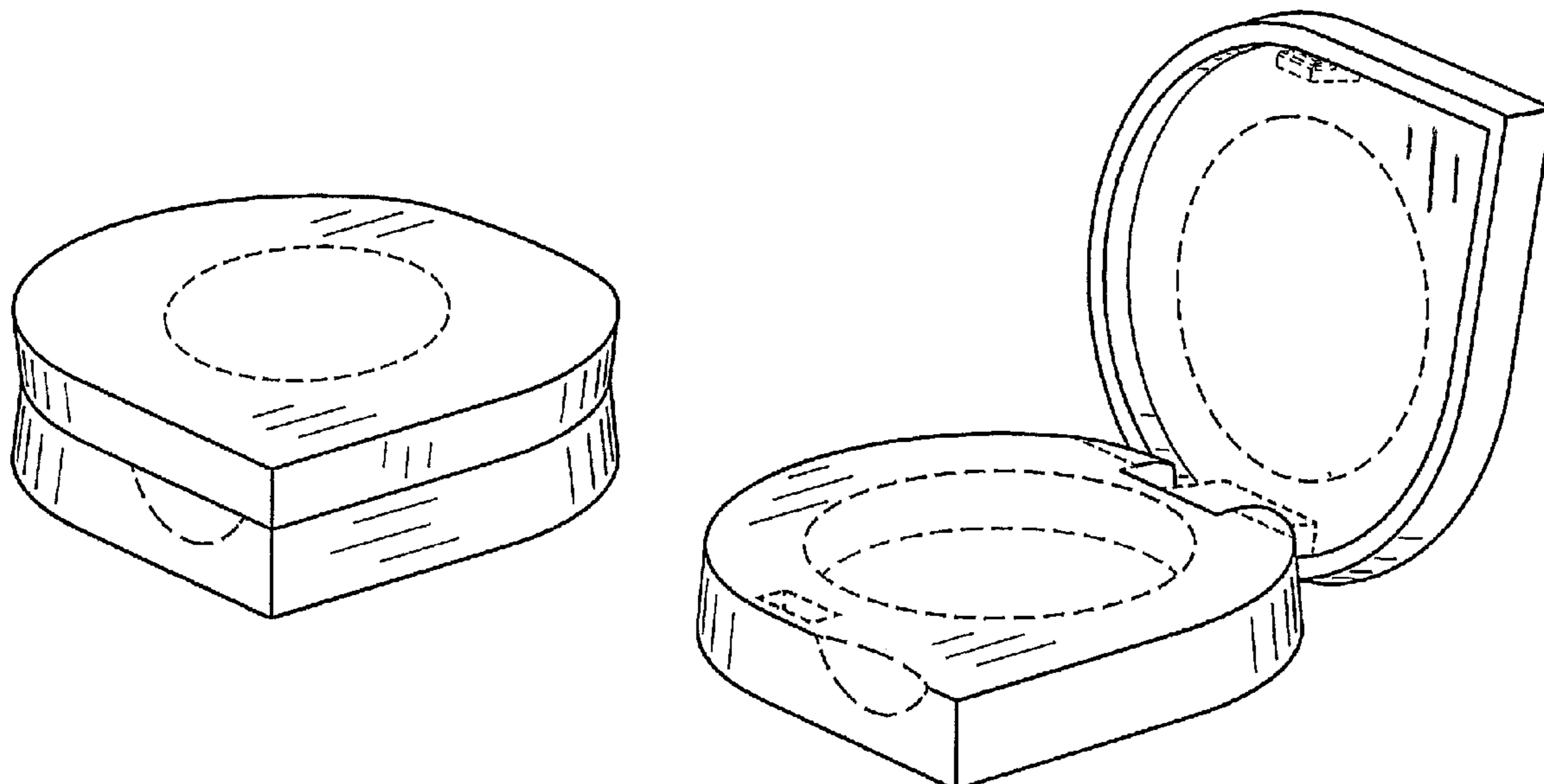

FIG. 1

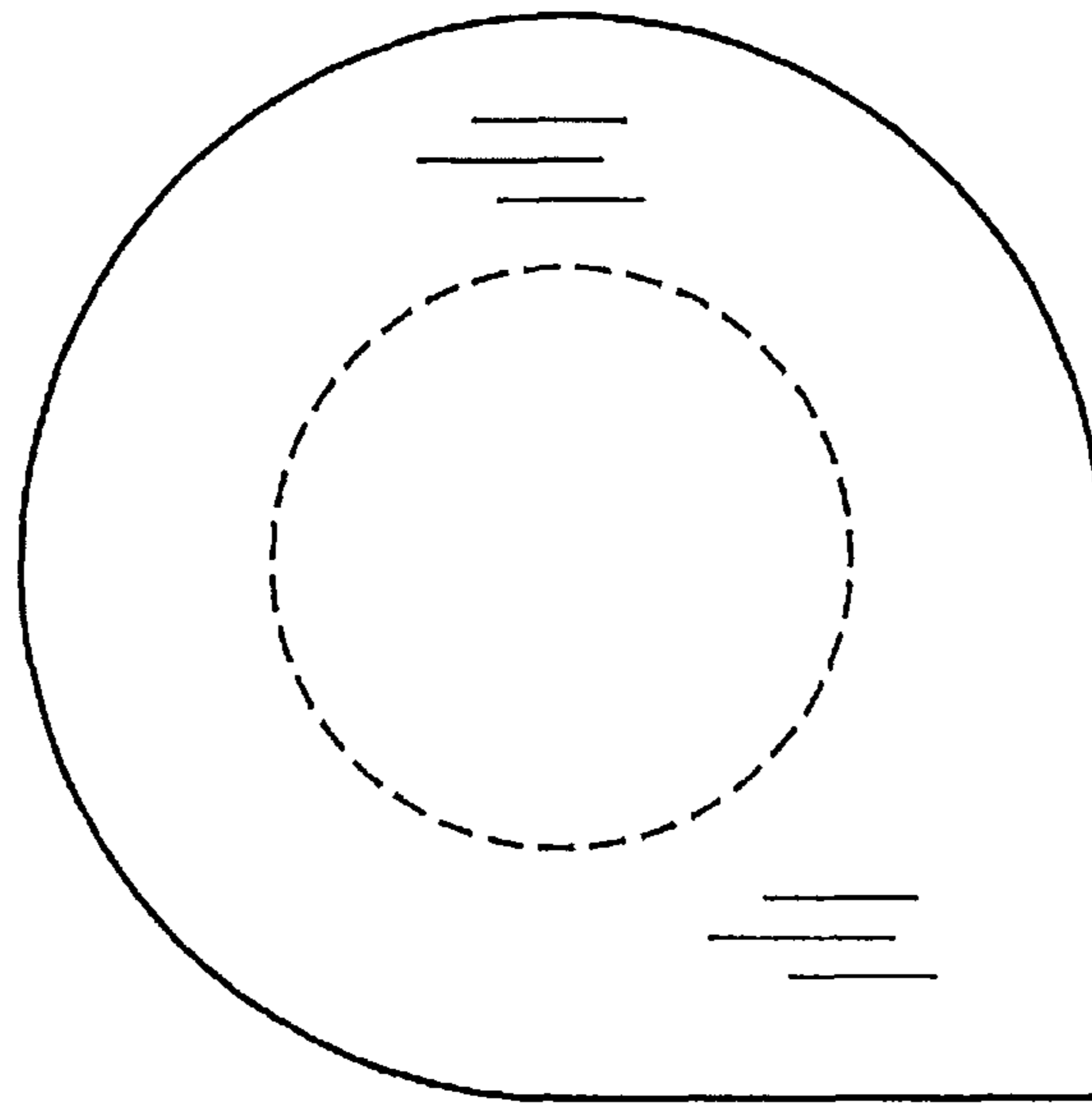

FIG. 2

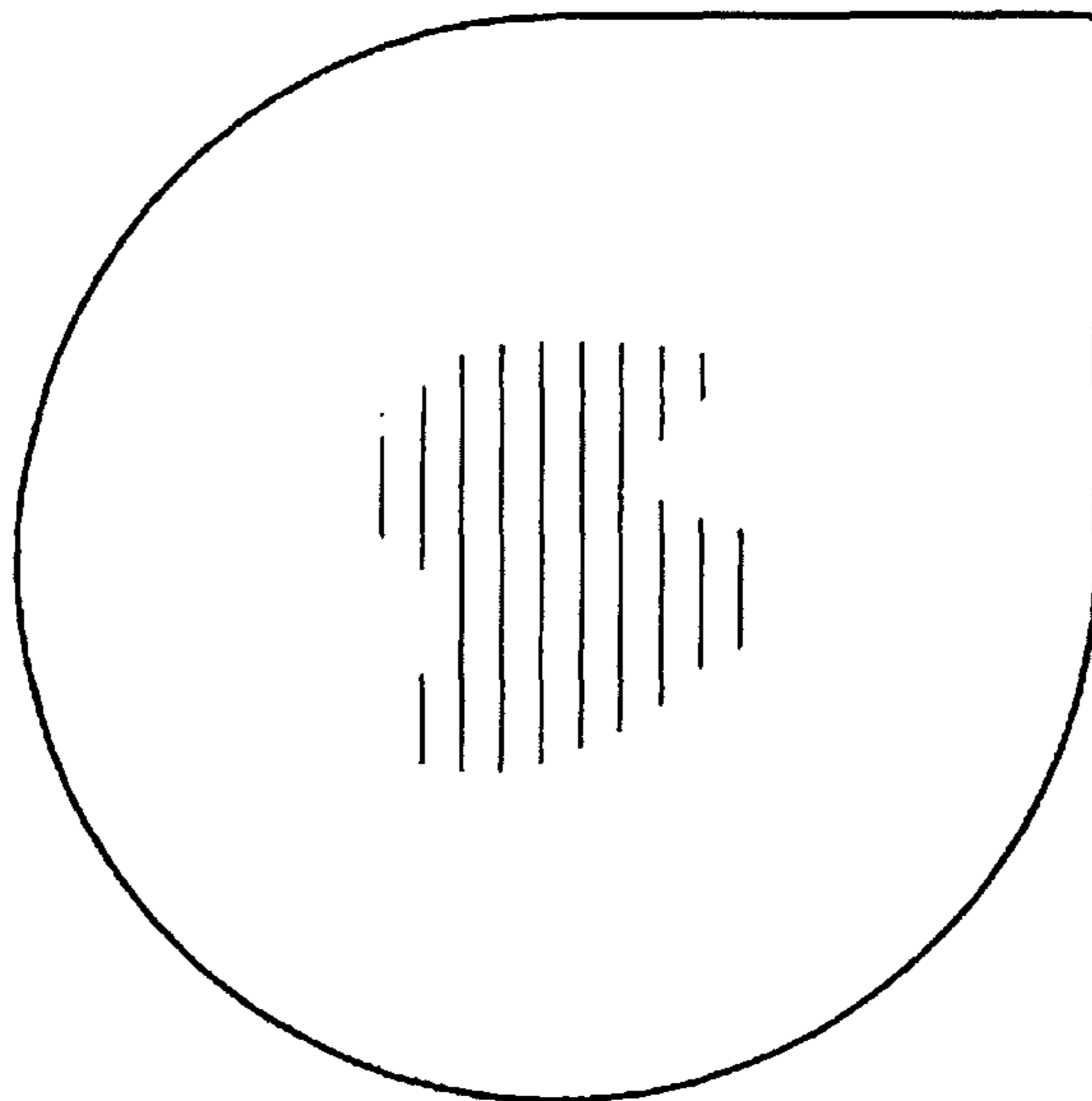

FIG. 3

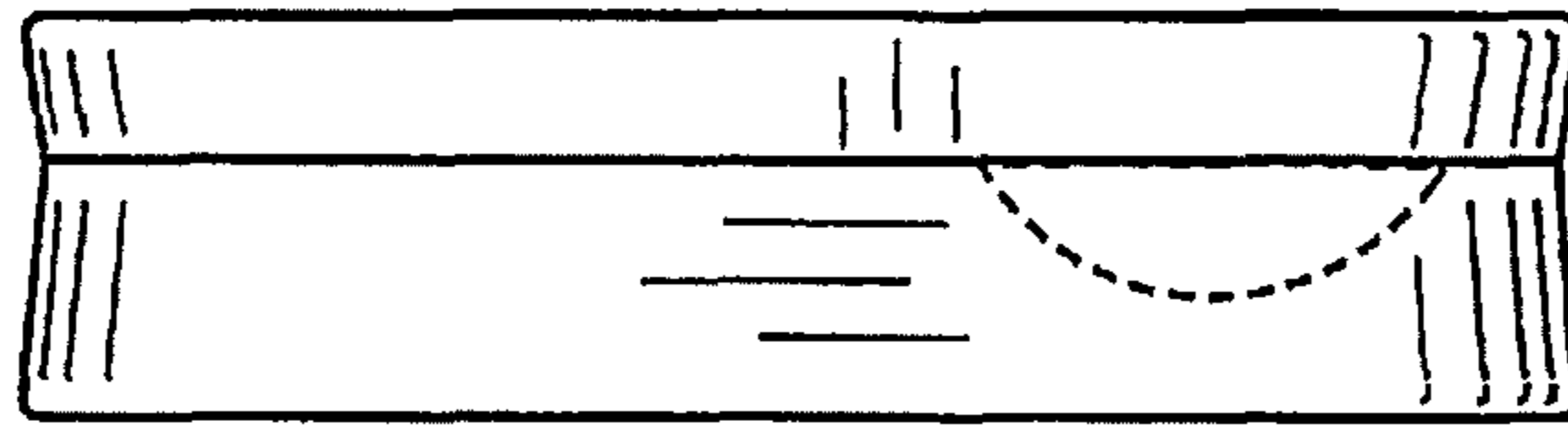

FIG. 4

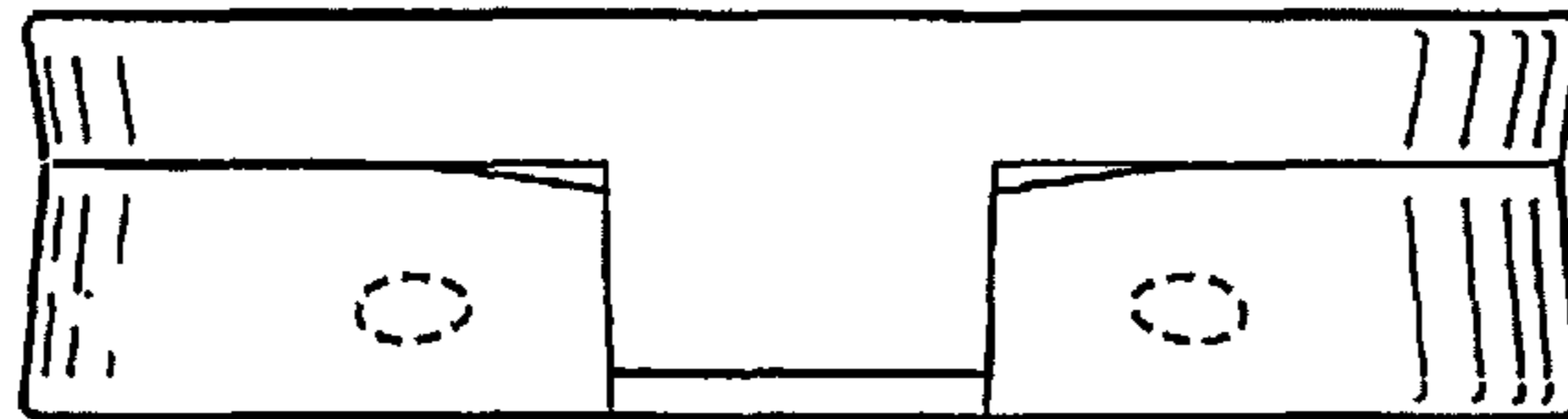

FIG. 5

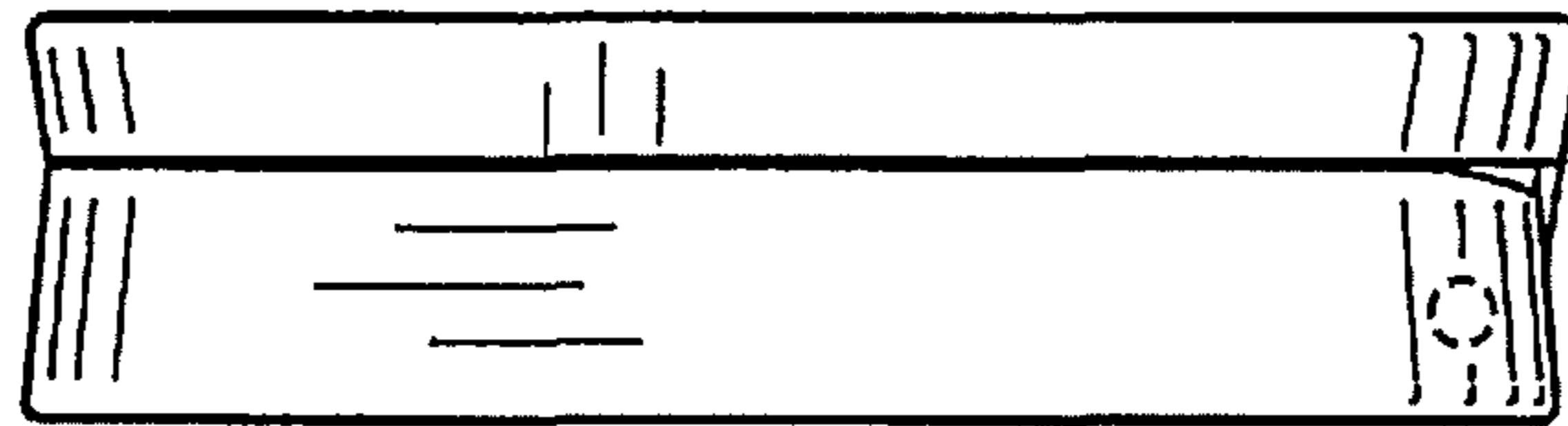

FIG. 6

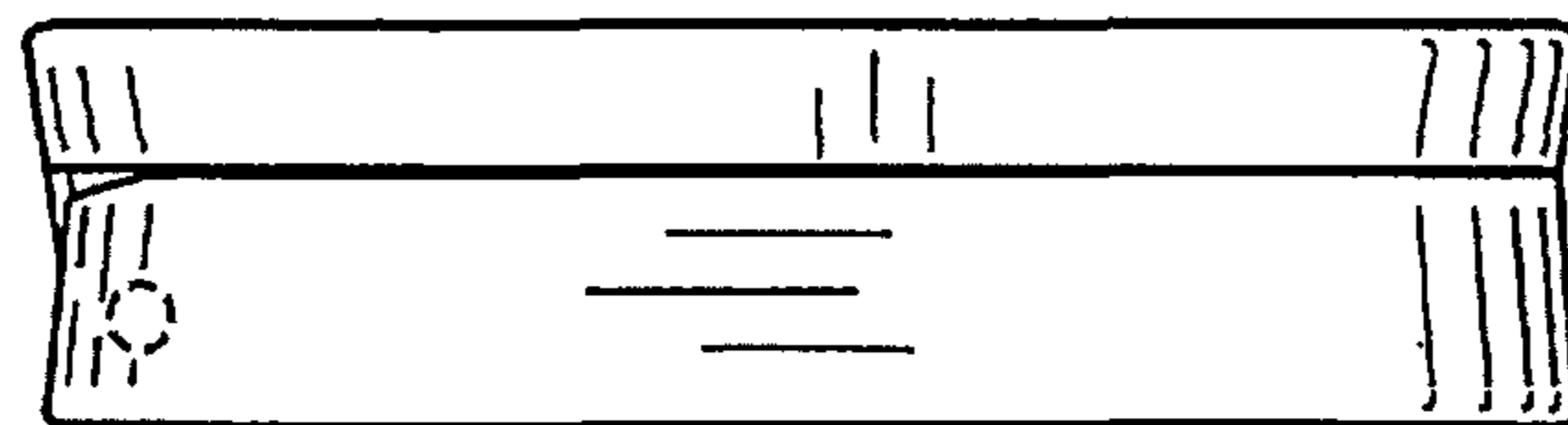

FIG. 7

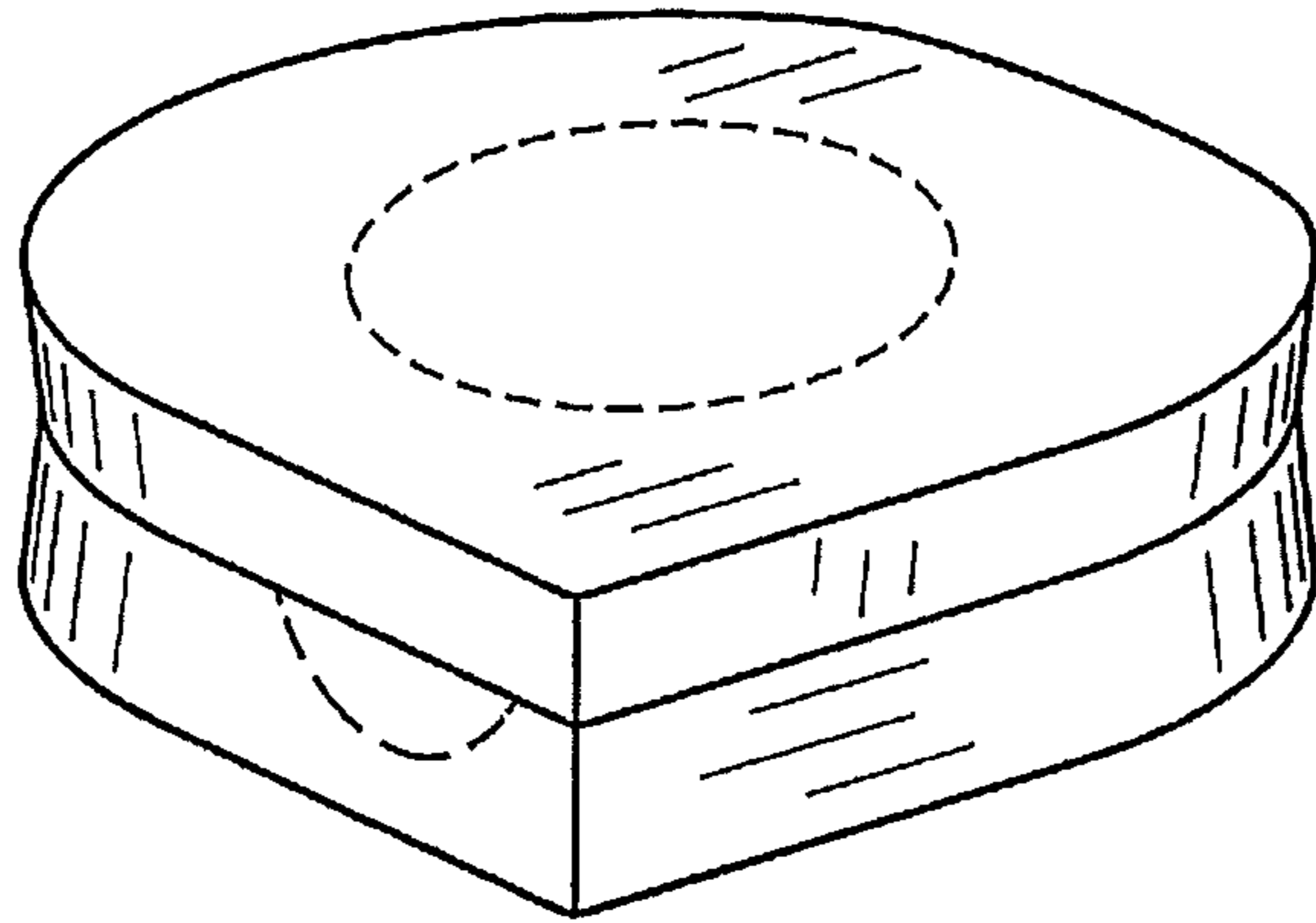

FIG. 8

