



US00D735842S

(12) **United States Design Patent**
Cole et al.

(10) **Patent No.:** **US D735,842 S**
(45) **Date of Patent:** **** Aug. 4, 2015**

(54) **CONDENSER HEAT EXCHANGER PLATE**

(71) Applicant: **The Abell Foundation, Inc.**, Baltimore, MD (US)

(72) Inventors: **Barry R. Cole**, Mineral, VA (US); **Laurence Jay Shapiro**, Fair Lawn, NJ (US); **Daniel Latimer Wilkins**, Saint Leonard, MD (US); **Barry Noel**, Montpelier, VA (US); **Hoseong Lee**, College Park, MD (US); **Yunho Hwang**, Ellicott City, MD (US)

(73) Assignee: **The Abell Foundation, Inc.**, Baltimore, MD (US)

(**) Term: **14 Years**

(21) Appl. No.: **29/442,396**

(22) Filed: **Feb. 22, 2013**

(51) **LOC (10) Cl.** **23-03**

(52) **U.S. Cl.**
USPC **D23/323**

(58) **Field of Classification Search**
USPC D23/314, 323, 330, 386, 499; 165/181, 165/121, 166, 167, 170, 150, 151, 182, 172
See application file for complete search history.

(56) **References Cited**

U.S. PATENT DOCUMENTS

1,622,703 A * 3/1927 Campbell 55/315.1
2,662,273 A 12/1953 Long

(Continued)

FOREIGN PATENT DOCUMENTS

DE 4137655 A1 * 5/1993

Primary Examiner — T. Chase Nelson

Assistant Examiner — Ania Aman

(74) *Attorney, Agent, or Firm* — Fish & Richardson P.C.

(57) **CLAIM**

The ornamental design for a condenser heat exchanger plate, substantially as shown and described.

DESCRIPTION

FIG. 1 shows a perspective view of a Design of a condenser heat exchange plate.

FIG. 2 shows a rear view of the Design.

FIG. 3 shows a front view of the Design.

FIG. 4 shows a left side view of the Design.

FIG. 5 shows a right side view of the Design.

FIG. 6 shows a top view of the Design.

FIG. 7 shows a bottom view of the Design.

FIG. 8 shows a cross-sectional view along line 8-8 of FIG. 3.

FIG. 9 shows a cross-sectional view along line 9-9 of FIG. 3.

FIG. 10 shows a cross-sectional view along line 10-10 of FIG. 3.

FIG. 11 shows a cross-sectional view along line 11-11 of FIG. 3.

FIG. 12 shows an enlarged view of a portion of the right side of the Design corresponding to the brace 12 of FIG. 3.

FIG. 13 shows an enlarged view of a portion of the right side of the Design corresponding to the brace 13 of FIG. 3.

FIG. 14 shows an enlarged view of a portion of the right side of the Design corresponding to the brace 14 of FIG. 3.

FIG. 15 shows an enlarged view of a portion of the right side of the Design corresponding to the brace 15 of FIG. 3.

FIG. 16 shows an enlarged view of a portion of the left side of the Design corresponding to the brace 16 of FIG. 3.

FIG. 17 shows an enlarged view of a portion of the left side of the Design corresponding to the brace 17 of FIG. 3.

FIG. 18 shows an enlarged view of a portion of the left side of the Design corresponding to the brace 18 of FIG. 3.

FIG. 19 shows an enlarged view of a portion of the left side of the Design corresponding to the brace 19 of FIG. 3.

FIG. 20 shows an enlarged view of the top of the Design corresponding to the brace 20 of FIG. 3.

FIG. 21 shows an enlarged view of the bottom of the Design corresponding to the brace 21 of FIG. 3; and,

FIG. 22 shows a cross-sectional view along line 22-22 of FIG. 1.

1 Claim, 9 Drawing Sheets

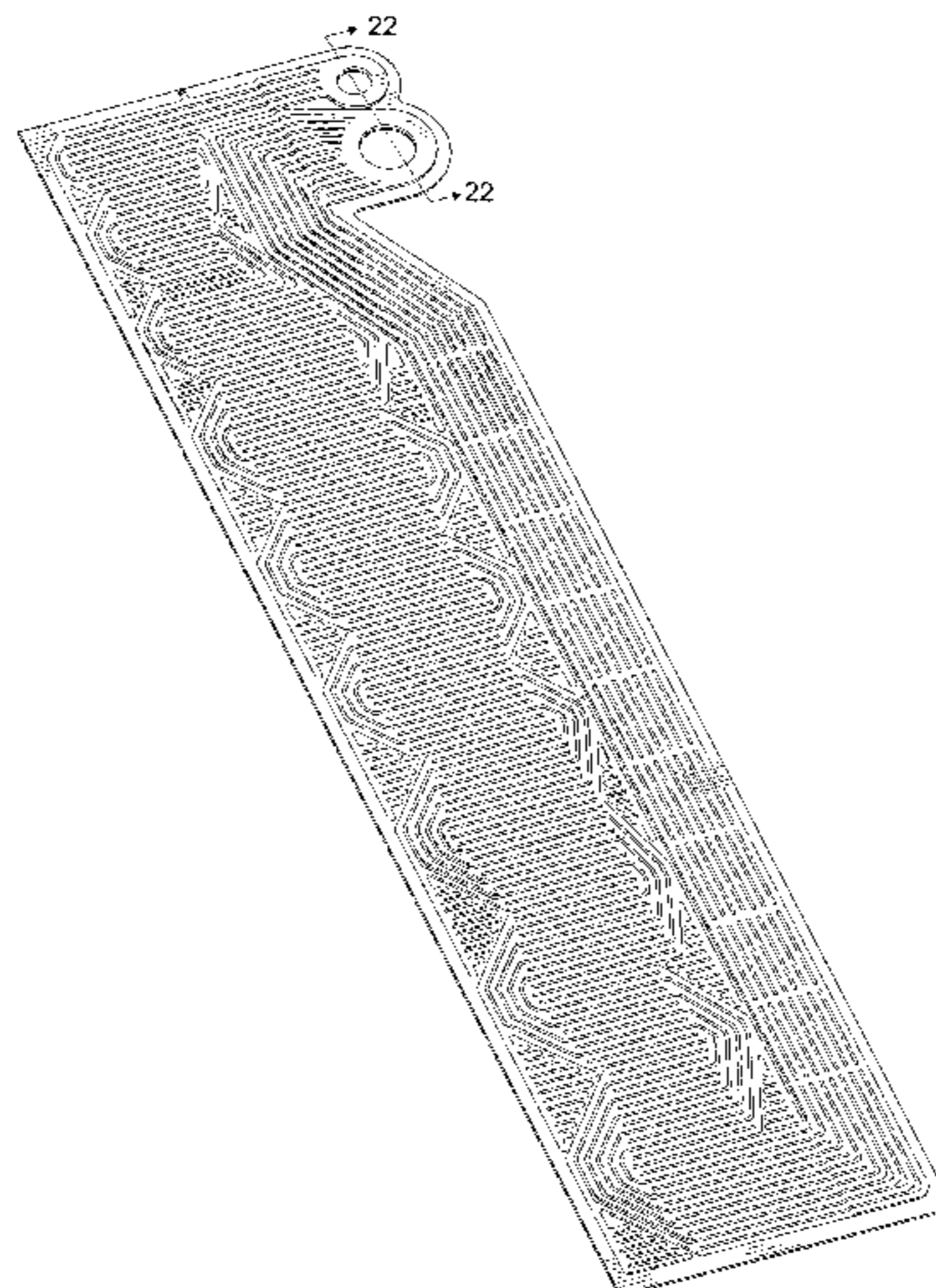

(56)

References Cited

U.S. PATENT DOCUMENTS

2,777,300	A	1/1957	Palmer				
3,233,662	A *	2/1966	Yuen	165/46			
3,291,206	A	12/1966	Nicholson				
D265,584	S *	7/1982	Butt et al.	D23/386			
4,476,856	A	10/1984	Cacarda				
4,574,876	A	3/1986	Aid				
4,646,815	A	3/1987	Iwata et al.				
5,680,897	A *	10/1997	Kilmer	165/178			
7,413,003	B2 *	8/2008	Oh et al.	165/153			
D657,854	S	4/2012	Hwang et al.				
D657,855	S	4/2012	Hwang et al.				
D657,856	S	4/2012	Hwang et al.				
D658,748	S	5/2012	Hwang et al.				
2004/0069470	A1 *	4/2004	Gorbulsky	165/158			
2004/0094291	A1 *	5/2004	Memory et al.	165/140			
2004/0144524	A1 *	7/2004	Hwang et al.	165/153			
2005/0045317	A1	3/2005	Huebner et al.				
2005/0115701	A1	6/2005	Martin et al.				
2005/0199372	A1 *	9/2005	Frazer et al.	165/80.4			
2006/0231241	A1 *	10/2006	Papapanu et al.	165/152			
2006/0278367	A1	12/2006	Dawson				
2006/0278382	A1 *	12/2006	Bhatti et al.	165/152			
2007/0062681	A1	3/2007	Beech				
2008/0078538	A1 *	4/2008	Jalilevand et al.	165/170			
2008/0196873	A1 *	8/2008	Svensson	165/167			
2009/0285956	A1 *	11/2009	Landers et al.	426/477			
2010/0084120	A1 *	4/2010	Yin et al.	165/146			
2010/0258284	A1 *	10/2010	Krantz	165/166			
2011/0053027	A1	3/2011	Weingaertner et al.				
2011/0168362	A1	7/2011	Hall et al.				
2013/0112382	A1 *	5/2013	Brunner et al.	165/166			
2013/0192806	A1 *	8/2013	Noishiki et al.	165/166			
2014/0026577	A1 *	1/2014	Reinke et al.	60/670			
2014/0060789	A1 *	3/2014	Rousseau	165/166			

* cited by examiner

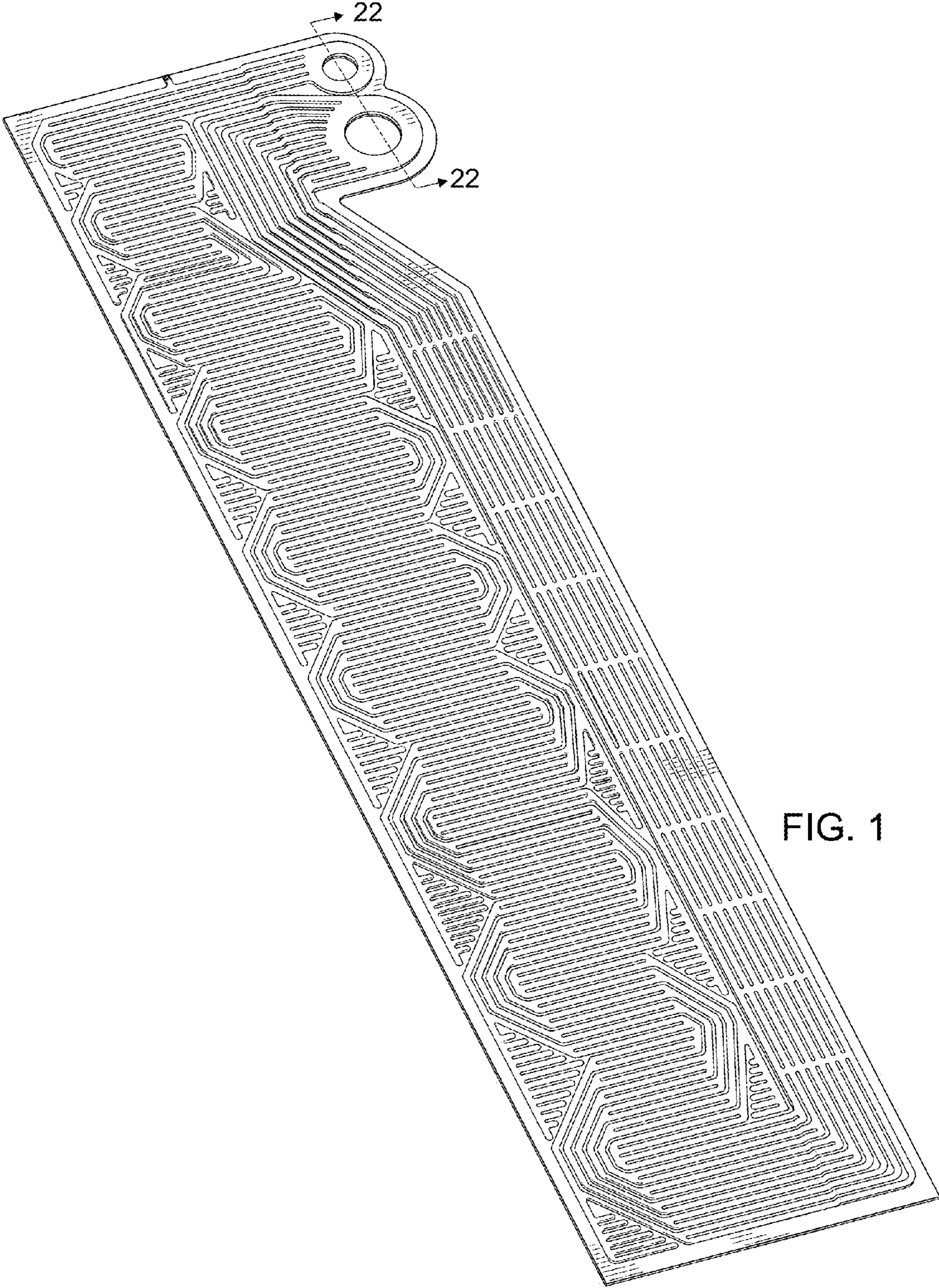

FIG. 1

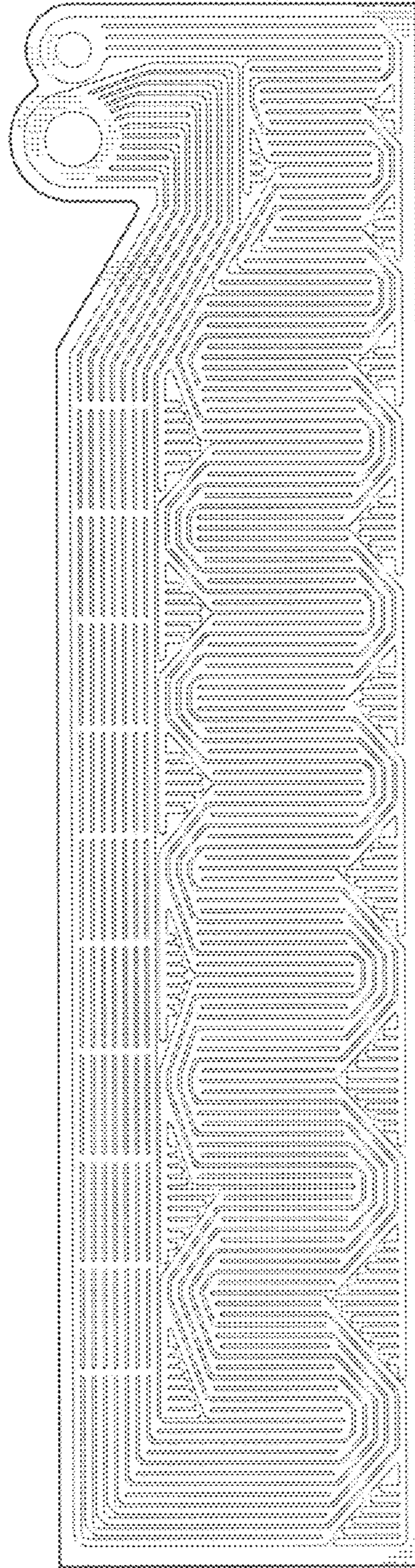
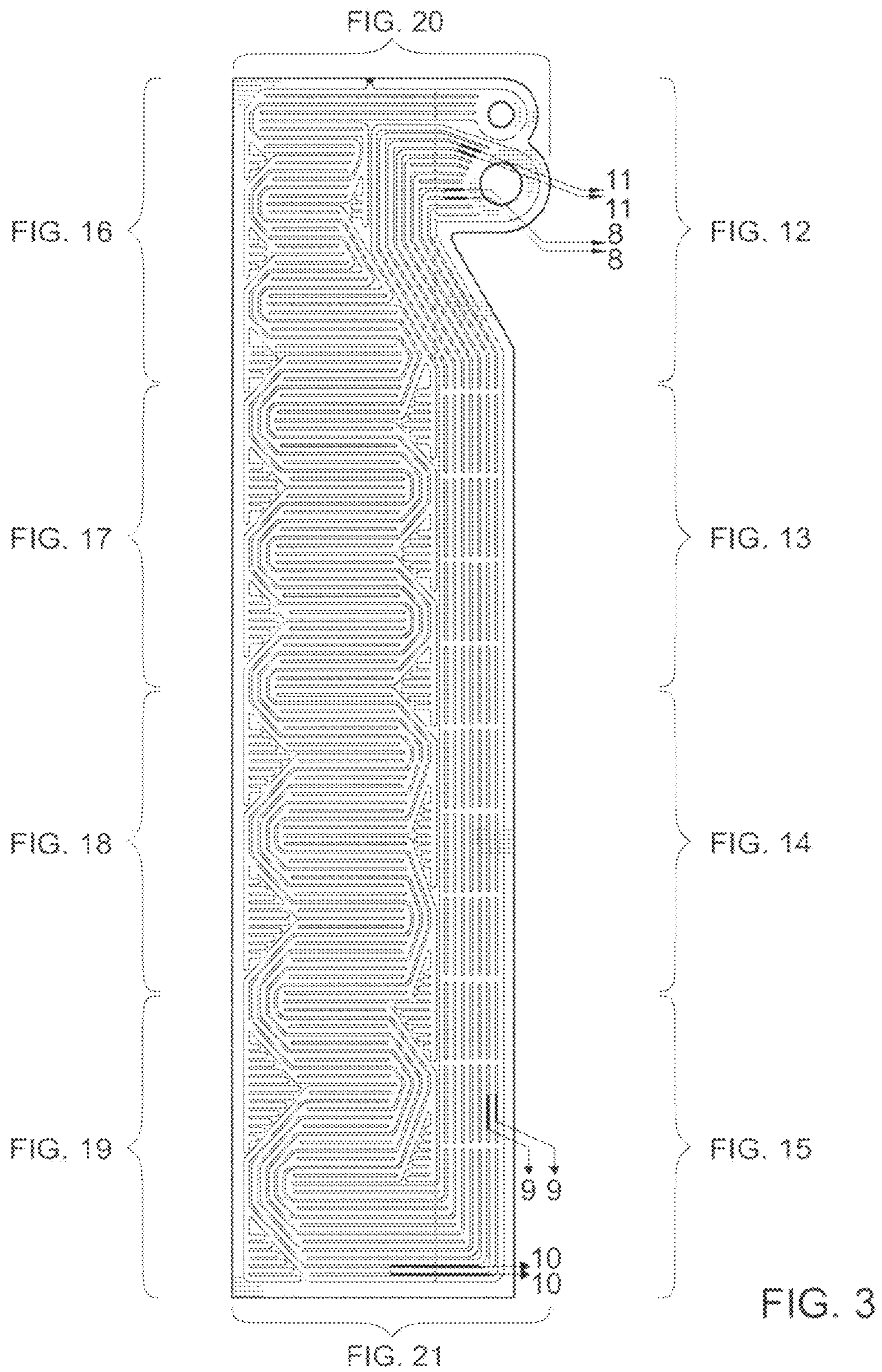

FIG. 2



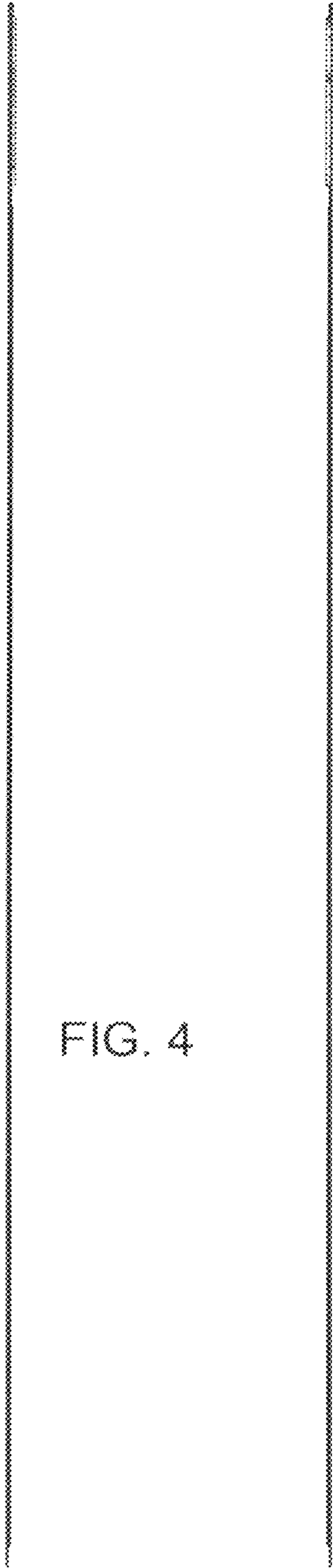

FIG. 4

FIG. 5

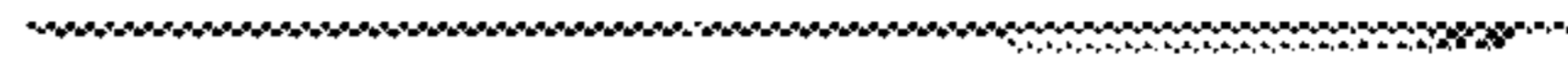

FIG. 6



FIG. 7

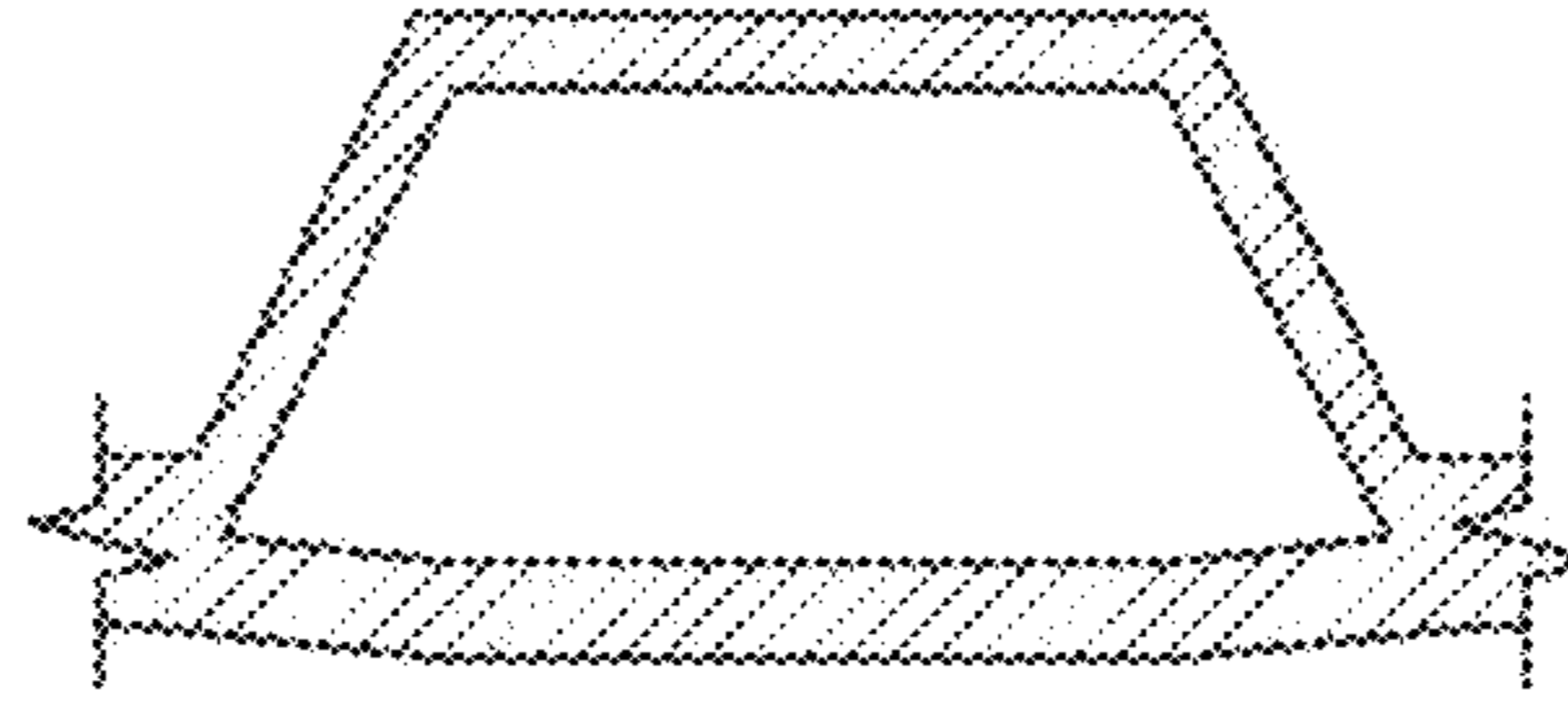

FIG. 8

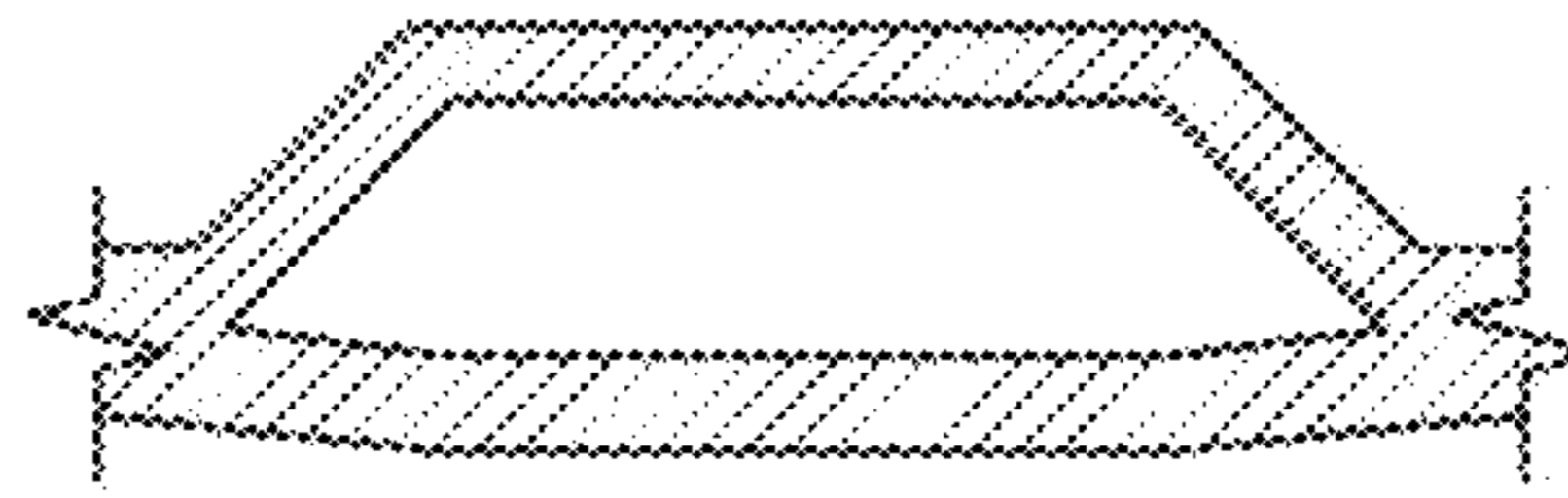

FIG. 9

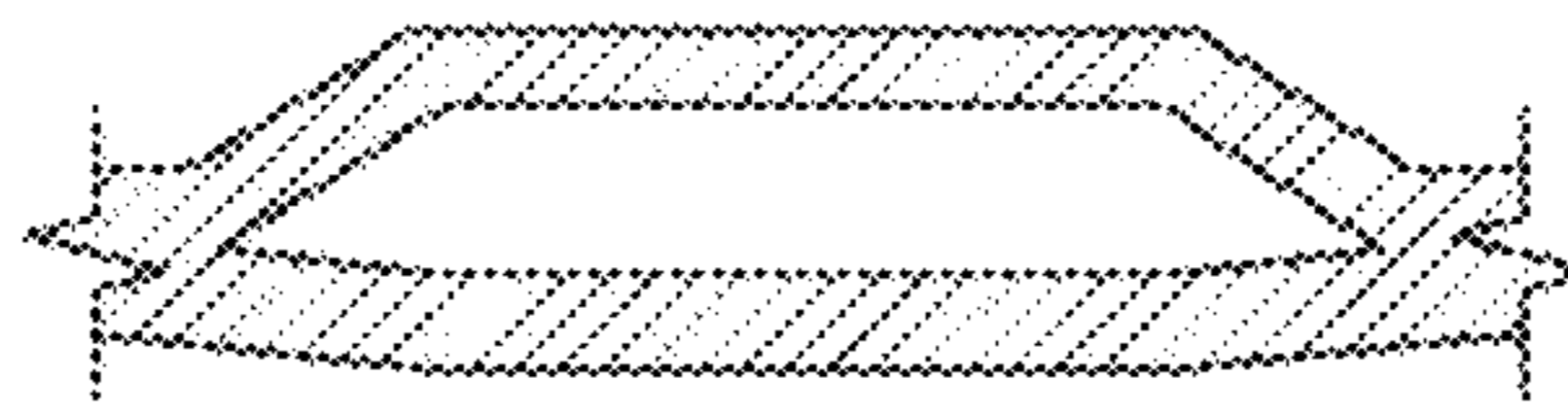

FIG. 10

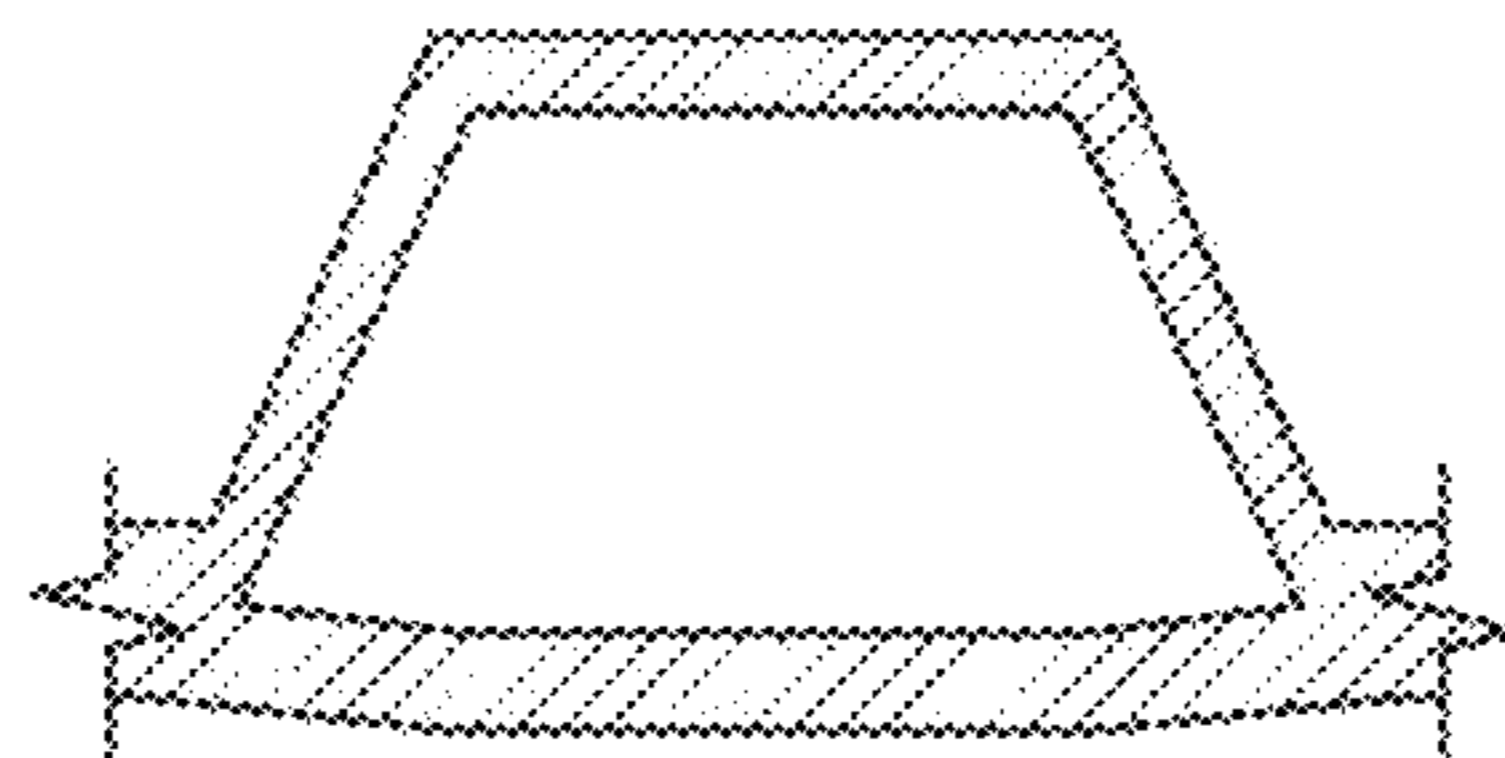

FIG. 11

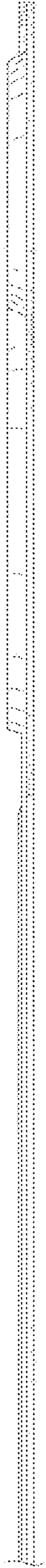

FIG. 12

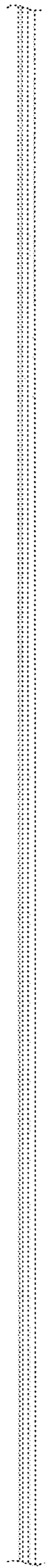

FIG. 13

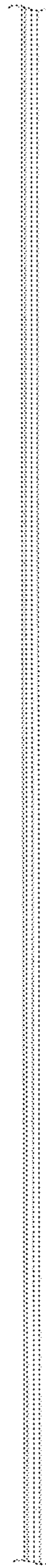

FIG. 14

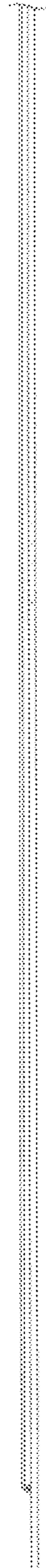

FIG. 15

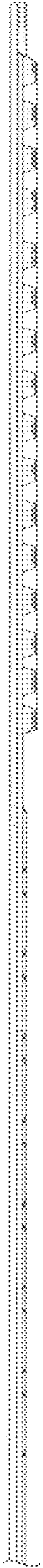

FIG. 16

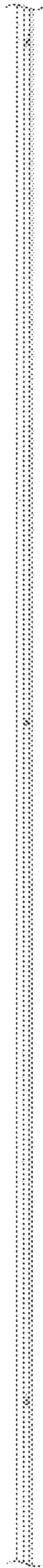

FIG. 17

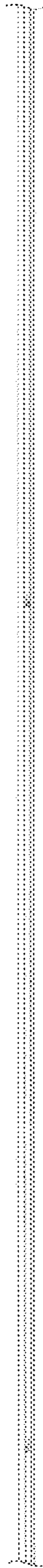

FIG. 18

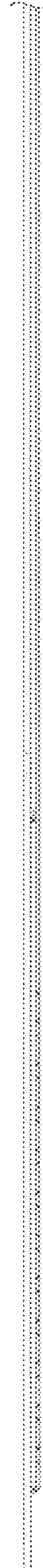

FIG. 19

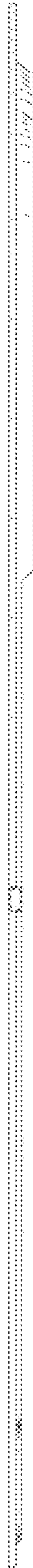

FIG. 20

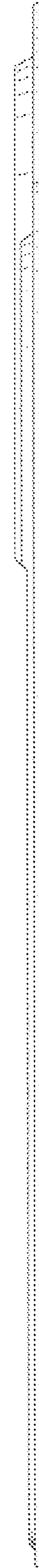

FIG. 21

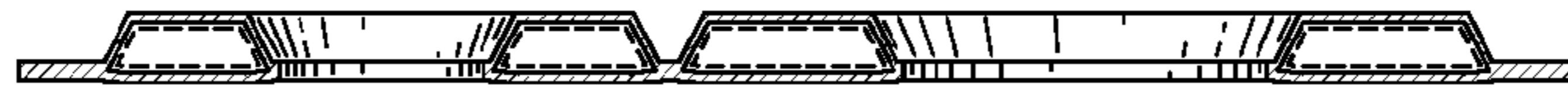

FIG. 22