



US00D735792S

(12) **United States Design Patent**  
**Ferman**

(10) **Patent No.:** **US D735,792 S**  
(45) **Date of Patent:** **\*\* Aug. 4, 2015**

- (54) **WEDGE SUPPORT FOR CAMERA**
- (71) Applicant: **Extreme Hunting Solutions, LLC**,  
Randolph, NJ (US)
- (72) Inventor: **Randall Ferman**, Randolph, NJ (US)
- (73) Assignee: **Extreme Hunting Solution, LLC**,  
Centerville, IA (US)
- (\*\*) Term: **14 Years**
- (21) Appl. No.: **29/446,625**
- (22) Filed: **Feb. 26, 2013**
- (51) **LOC (10) Cl.** ..... **16-05**
- (52) **U.S. Cl.**  
USPC ..... **D16/242**
- (58) **Field of Classification Search**  
USPC ..... D16/219, 242; 248/673; 348/169;  
396/427  
See application file for complete search history.

8,657,508 B1 2/2014 Ferman  
 D712,726 S 9/2014 Perrin  
 D714,807 S 10/2014 Pulver  
 2002/0085844 A1 7/2002 Tashiro et al.  
 2008/0136916 A1 6/2008 Wolff  
 2014/0147105 A1 5/2014 Ferman

FOREIGN PATENT DOCUMENTS

CA 110642 \* 7/2006

OTHER PUBLICATIONS

ATA 2013 Trade Show, Randall Ferman, "The Wedge", Jan. 2013.  
Extreme Hunting Solutions website, "The Wedge", 2013.

\* cited by examiner

*Primary Examiner* — Susan Bennett Hattan  
*Assistant Examiner* — Leanne Was

(74) *Attorney, Agent, or Firm* — Lerner, David, Littenberg,  
Krumholz & Mentlik, LLP

(57) **CLAIM**

The ornamental design for a wedge support for camera, as shown and described.

(56) **References Cited**

U.S. PATENT DOCUMENTS

D152,540 S *	2/1949	Heward	.....	D16/242
D187,713 S	4/1960	Barzman et al.		
D284,738 S	7/1986	Stone		
D295,248 S	4/1988	Sommerfield et al.		
D300,856 S	4/1989	Bojsen-Moller		
D303,120 S *	8/1989	Cavdek	.....	D16/242
D323,668 S *	2/1992	Schwartz et al.	.....	D16/242
D324,530 S *	3/1992	Blaylock	.....	D16/242
D406,028 S	2/1999	Montgomery		
D452,509 S	12/2001	Allsop		
D476,662 S	7/2003	Knieper		
D538,150 S	3/2007	Burns et al.		
D577,943 S	10/2008	Larsen		
D590,676 S	4/2009	Pickard		
7,905,465 B1	3/2011	Anwar		
D664,148 S	7/2012	Josefek		

**DESCRIPTION**

FIG. 1 is a front perspective view of a wedge support for camera showing my new design;  
FIG. 2 is a left side elevation view thereof, the right side being a mirror image thereof;  
FIG. 3 is a back plan view thereof;  
FIG. 4 is a bottom elevation view thereof;  
FIG. 5 is a top elevation view thereof; and,  
FIG. 6 is a back perspective view thereof.  
The broken lines in the drawings depict unclaimed portions of the wedge support for camera and form no part of the claimed design.

**1 Claim, 6 Drawing Sheets**

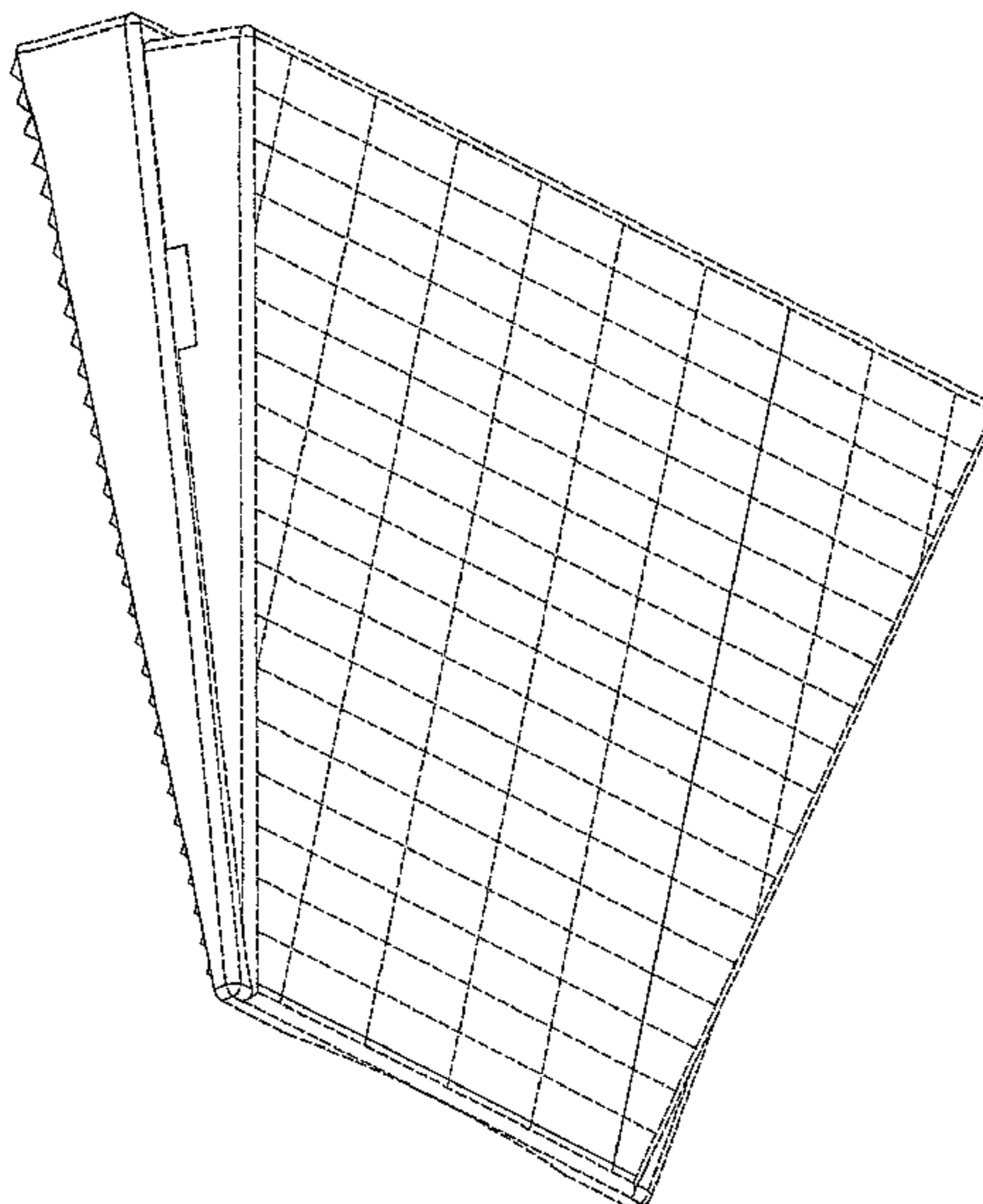

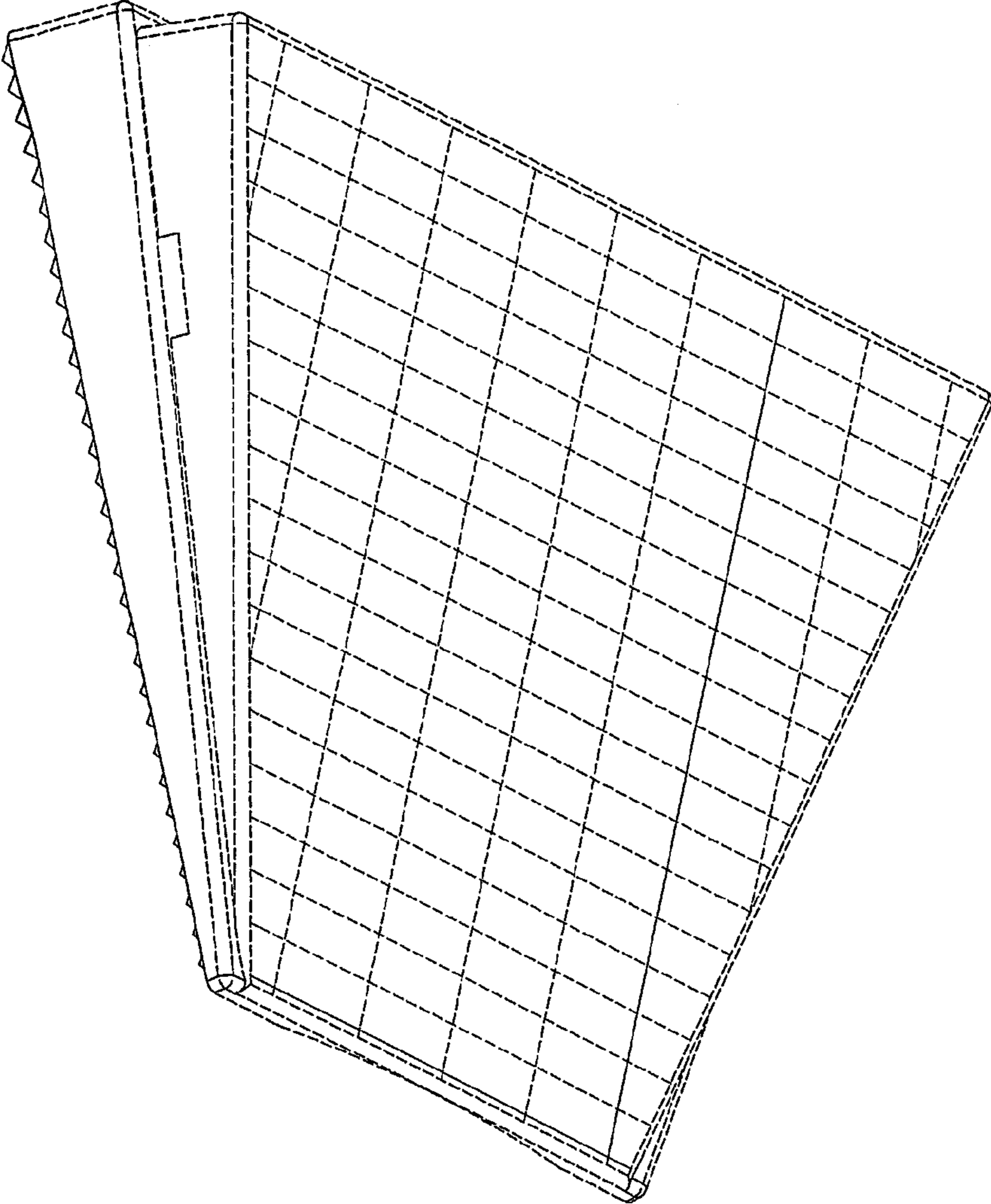

FIG. 1

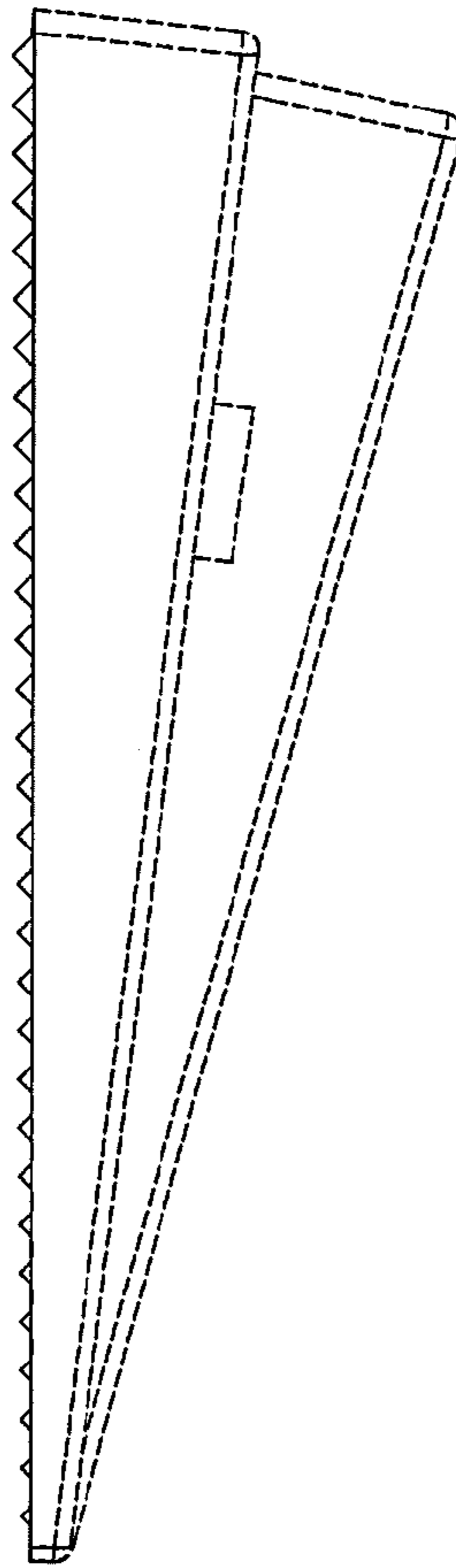

FIG. 2

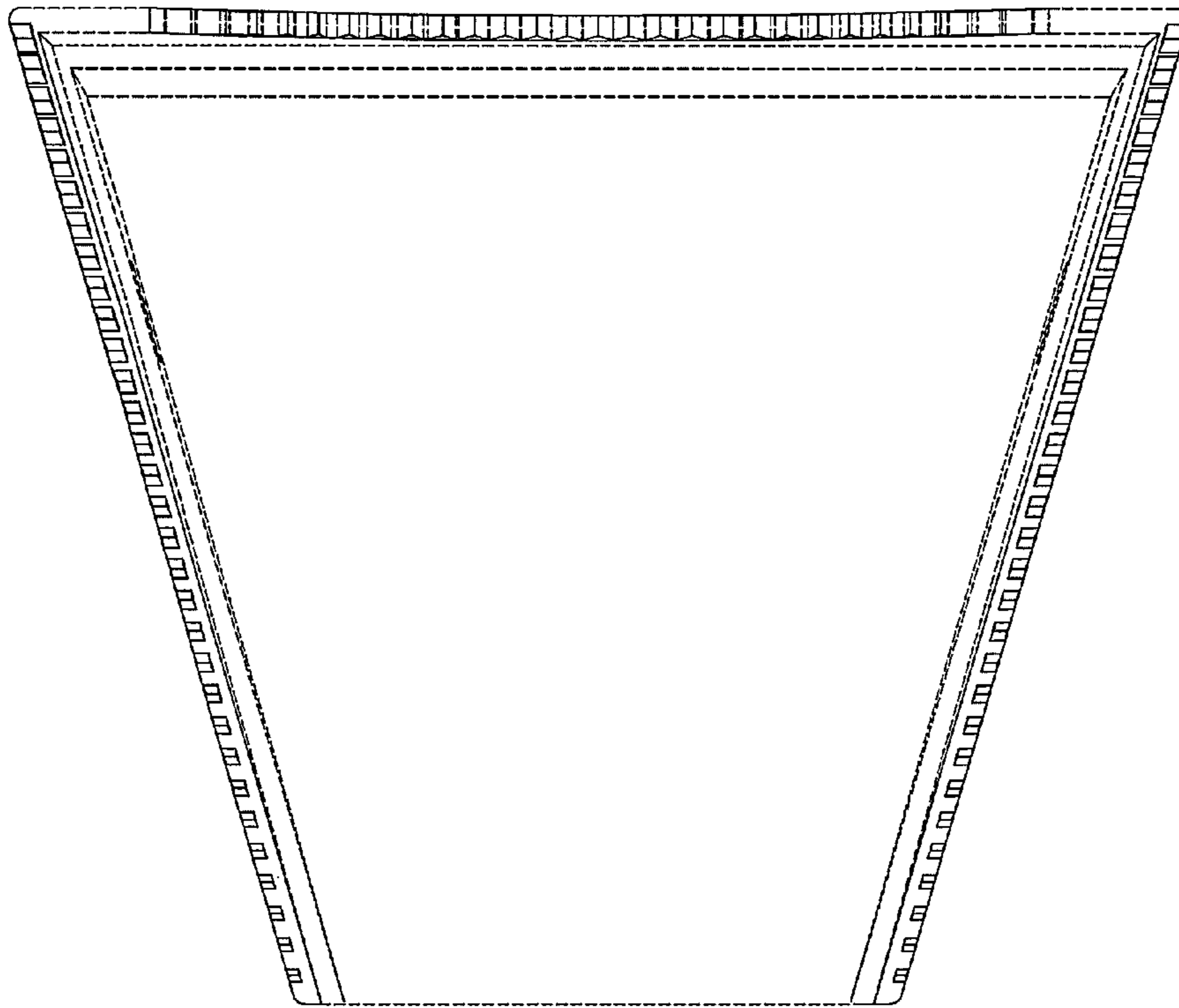

FIG. 3

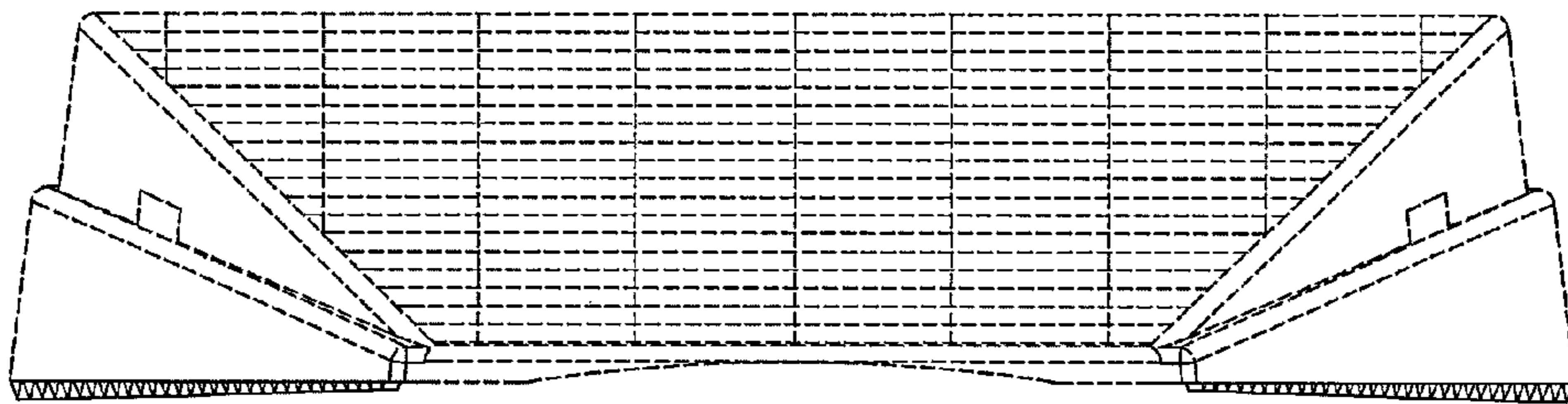

FIG. 4

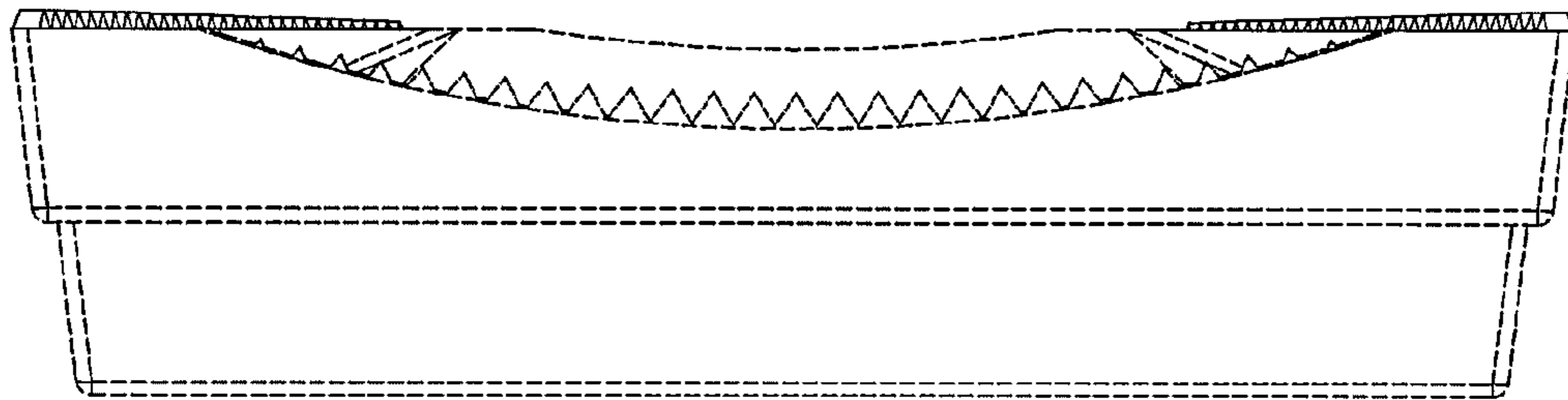

FIG. 5

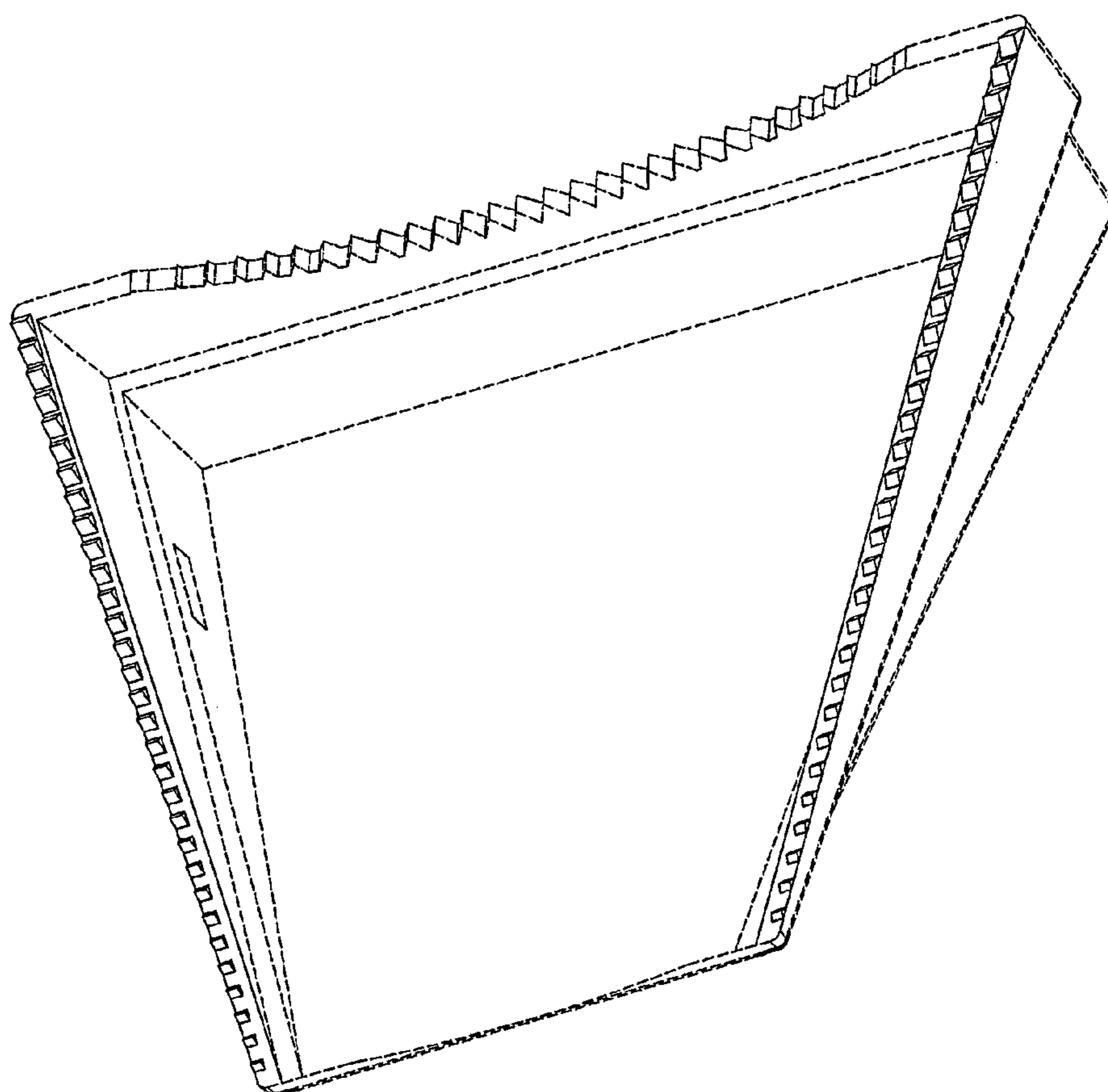

FIG. 6