



US00D735725S

(12) **United States Design Patent**
Lim et al.

(10) **Patent No.:** **US D735,725 S**
(45) **Date of Patent:** **** Aug. 4, 2015**

(54) **MEMORY CARD**

(71) Applicant: **SAMSUNG ELECTRONICS CO., LTD.**, Suwon-si (KR)

(72) Inventors: **Gwang-Man Lim**, Seoul (KR); **Il-Mok Kang**, Suwon-si (KR); **Seok-Jae Han**, Seoul (KR); **Sang-Chul Kang**, Hwaseong-si (KR); **Seok-Cheon Kwon**, Yongin-si (KR); **Seok-Chan Lee**, Hwaseong-si (KR)

(73) Assignee: **SAMSUNG ELECTRONICS CO., LTD.**, Suwon-si (KR)

(**) Term: **14 Years**

(21) Appl. No.: **29/507,436**

(22) Filed: **Oct. 28, 2014**

(30) **Foreign Application Priority Data**

May 2, 2014 (KR) 30-2014-0022382

(51) **LOC (10) Cl.** **14-02**

(52) **U.S. Cl.**
USPC **D14/436**

(58) **Field of Classification Search**

USPC D14/435-438, 478-480; 235/441, 443, 235/487, 492, 493, 495; 361/737, 679, 752, 361/736, 728, 796, 797, 729, 730, 361/725-727; 257/678, 679, 693, E23.064; 439/946, 948, 159; 174/250, 260, 52.1, 174/52.2; 710/300-303; 438/121

CPC G06K 19/06196; G06K 19/072; G06K 19/0721; G06K 19/0722; G06K 19/0723; G06K 19/0724; G06K 19/0725; G06K 19/0726; G06K 19/0727; G06K 19/0728; G06K 19/073; G06K 19/07309; G06K 19/077; G06K 19/07701; G06K 19/07715; G06K 19/0772; G06K 19/07722; G06K 19/07724; G06K 19/07726; G06K 19/07728; G06K 19/0773; G06K 19/07735; G06K 19/07737; G06K 19/07739; G06K

19/07741; G06K 19/07743; G06K 19/07745; G06K 19/07747; G06K 19/07749; G06K 19/07758; G06K 19/07767; G06K 19/07769; G06K 19/07771; G06K 19/07773; G06K 19/07775; G06K 19/083; G06K 19/086; G06K 19/145; G06K 19/18; G06K 2215/0022; G06K 2215/0025; G06K 2215/0028; G06K 2215/0031; G06K 2215/004; G06K 2215/0082; G06F 21/86; G06F 21/87; G06F 21/77-21/80; G06F 21/85-21/88; G06F 21/00; G06Q 20/3229; G06Q 20/34; G06Q 20/341; G06Q 20/346; G06Q 20/349; G06Q 20/3563; G06Q 20/3567; G06Q 20/357; G06Q 20/3576; H05K 5/026; H05K 5/0256; H05K 5/0265; H05K 5/0269; H05K 5/0273; H05K 5/0278; H05K 5/0282; H05K 5/0286; H05K 5/0291; H05K 5/0295; H05K 5/03; H05K 5/04; H05K 5/061; H05K 5/062; H05K 5/063; H05K 5/064; H05K 5/065; H05K 5/066; H05K 5/067; H05K 5/068; H05K 5/069; H05K 7/00; H05K 7/005; H05K 7/02; H05K 7/023; H05K 7/026; H05K 7/04; H05K 7/10; H05K 7/1418; H05K 7/142; H05K 7/1424; H05K 7/1427-7/1439; H05K 7/1461; H05K 7/1464-7/1474; H05K 7/1479; H05K 7/1481; H05K 7/1485-7/1488; H05K 2201/09745; H05K 2201/09754; H05K 2201/09763; H05K 2201/09772; H05K 2201/098; H05K 2201/09818; H05K 2201/10; H05K 2201/10007; H05K 2201/10098; H05K 2201/10143; H05K 2201/10159; H05K 2201/10174; H05K 2201/10212; H05K 2201/1028; H05K 2201/1031; H05K 2201/10431; H05K 2201/10462; H05K 2201/10545; H05K 2201/10553; H05K 2201/1056; H05K 2201/10621; H05K 2201/10636; H05K 2203/05; H05K 3/368; H05K 3/3436; H05K 3/36; H05K 3/40; H05K 3/4007; H05K 3/4015; H05K 3/403; H05K 3/4053; H05K 3/4092; H05K 3/42; H05K 3/421; H05K 3/46; H05K 1/14; H05K 1/141; H05K 1/142; H05K 1/144; H05K 1/145; H05K 1/182; H04N 2201/216

See application file for complete search history.

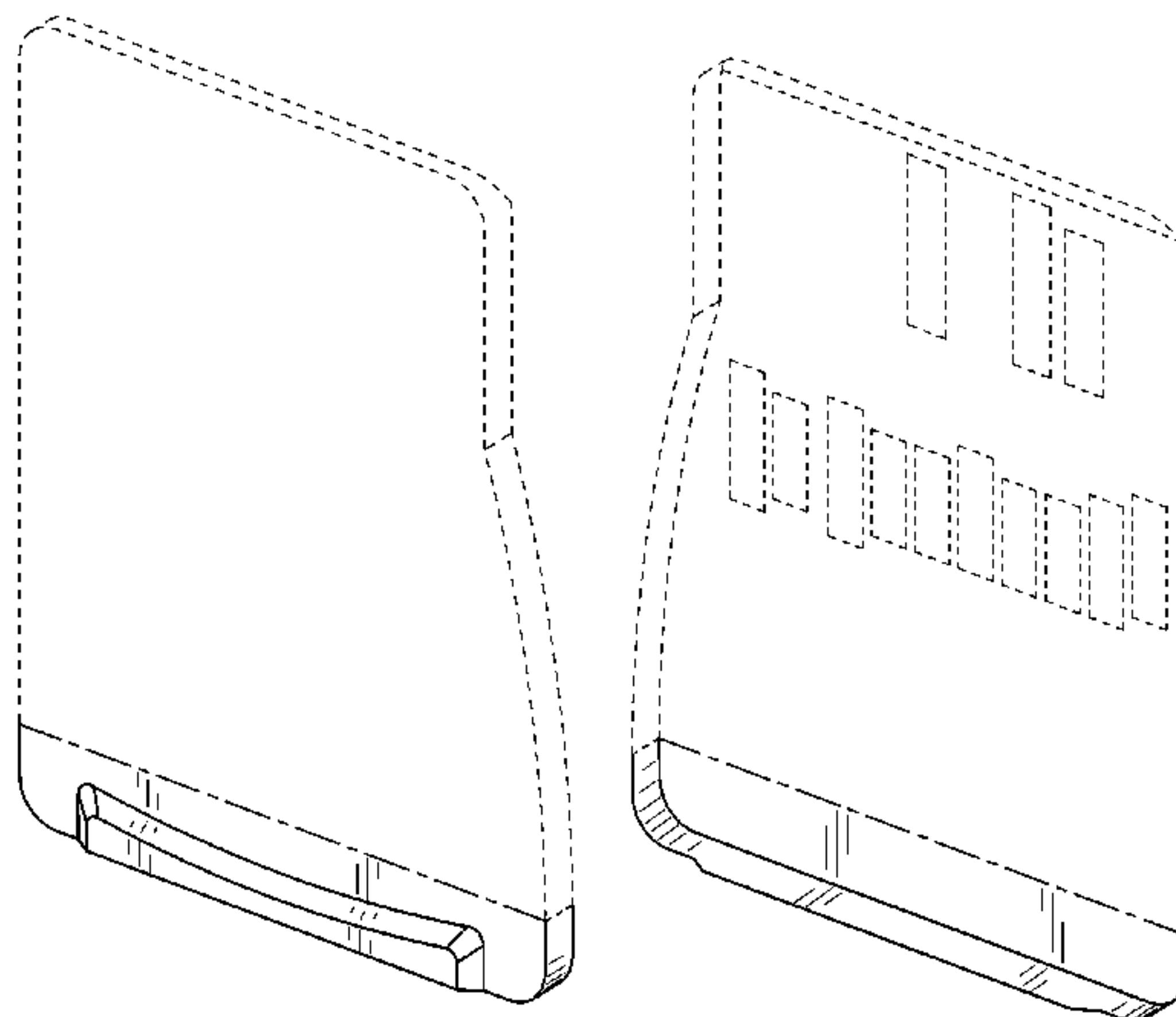

(56)

References Cited

U.S. PATENT DOCUMENTS

D294,020 S * 2/1988 Yukawa D14/435
 4,865,321 A * 9/1989 Nakagawa et al. 463/29
 D319,823 S * 9/1991 Kojo D14/438
 D350,951 S * 9/1994 Tseng D14/435
 5,362,068 A * 11/1994 Liu 463/44
 D368,082 S * 3/1996 Goto D14/435
 D371,353 S * 7/1996 Ashida et al. D14/438
 D375,304 S * 11/1996 Takahata et al. D14/435
 D381,977 S * 8/1997 Nagata et al. D14/438
 5,653,638 A * 8/1997 Nagata 463/44
 5,671,109 A * 9/1997 Sumner et al. 360/133
 5,694,278 A * 12/1997 Sumner 360/133
 D393,454 S * 4/1998 Cruden et al. D14/475
 D396,707 S * 8/1998 Ashida D14/480
 D406,831 S * 3/1999 Takahashi et al. D14/479
 5,926,438 A * 7/1999 Saito 367/111
 D419,198 S * 1/2000 Ashida et al. D21/332
 D445,796 S * 7/2001 Hoferitza et al. D14/436
 D452,281 S * 12/2001 Ohno D21/332
 D468,743 S * 1/2003 Kawanobe et al. D14/435
 D475,056 S * 5/2003 Taniguchi et al. D14/436
 D475,713 S * 6/2003 Taniguchi et al. D14/436
 D476,012 S * 6/2003 Taniguchi et al. D14/436
 D486,498 S * 2/2004 Stamm et al. D14/481
 D492,686 S * 7/2004 Yu et al. D14/436
 D493,798 S * 8/2004 Yu et al. D14/436
 D509,219 S * 9/2005 Avery D14/435
 D516,076 S * 2/2006 Ko D14/436
 D539,355 S * 3/2007 Fujita D21/332
 D546,896 S * 7/2007 Ibuki D21/332
 D550,775 S * 9/2007 Fujita D21/332
 7,371,119 B1 * 5/2008 Lee 439/630
 7,392,343 B2 * 6/2008 Oshima 711/115
 7,455,555 B1 * 11/2008 Lai 439/630
 D585,068 S * 1/2009 Elliott et al. D14/436
 D586,349 S * 2/2009 Matsumoto et al. D14/436
 D588,598 S * 3/2009 Nakamura D14/436
 D604,738 S * 11/2009 Matsumoto et al. D14/436
 7,798,840 B2 * 9/2010 Hubert et al. 439/377
 7,866,999 B2 * 1/2011 Matsunaga 439/159
 7,901,225 B2 * 3/2011 Maruyama 439/159
 7,909,650 B2 * 3/2011 Matsunaga 439/630
 7,927,117 B2 * 4/2011 Yu et al. 439/159

D641,050 S * 7/2011 Matsui et al. D21/332
 8,142,229 B1 * 3/2012 Bobuk et al. 439/630
 D670,292 S * 11/2012 Komatani et al. D14/436
 D681,640 S * 5/2013 Aoki et al. D14/436
 8,649,820 B2 * 2/2014 Schwandt et al. 455/557
 8,747,162 B2 * 6/2014 Sherry 439/630
 2004/0027809 A1 * 2/2004 Takahashi et al. 361/737
 2005/0021909 A1 * 1/2005 Much et al. 711/115
 2005/0253239 A1 * 11/2005 Nishizawa et al. 257/679
 2007/0217166 A1 * 9/2007 Liu 361/737
 2008/0049392 A1 * 2/2008 Takiar 361/684
 2008/0235939 A1 * 10/2008 Hiew et al. 29/831
 2009/0061688 A1 * 3/2009 Aoki et al. 439/628
 2010/0087074 A1 * 4/2010 Yu et al. 439/81
 2012/0133258 A1 * 5/2012 Giustina et al. 312/326
 2014/0024236 A1 * 1/2014 Little et al. 439/159
 2014/0040521 A1 * 2/2014 Kuo et al. 710/301
 2014/0301032 A1 * 10/2014 Stone et al. 361/679.32

* cited by examiner

Primary Examiner — Susan Moon Lee

(74) Attorney, Agent, or Firm — Sughrue Mion, PLLC

(57)

CLAIM

The ornamental design for a memory card, as shown and described.

DESCRIPTION

FIG. 1 is the perspective view of the memory card showing our new design;
 FIG. 2 is a front view thereof;
 FIG. 3 is a rear view thereof;
 FIG. 4 is a left-side view thereof;
 FIG. 5 is a right-side view thereof;
 FIG. 6 is a top plan view thereof;
 FIG. 7 is a bottom plan view thereof; and,
 FIG. 8 is a rear perspective view thereof.
 Broken lines and entirely unshaded portions contained within broken lines are not claimed.
 The dot dash boundary lines indicate the border at which the claimed portion terminates.

1 Claim, 6 Drawing Sheets

FIG. 1

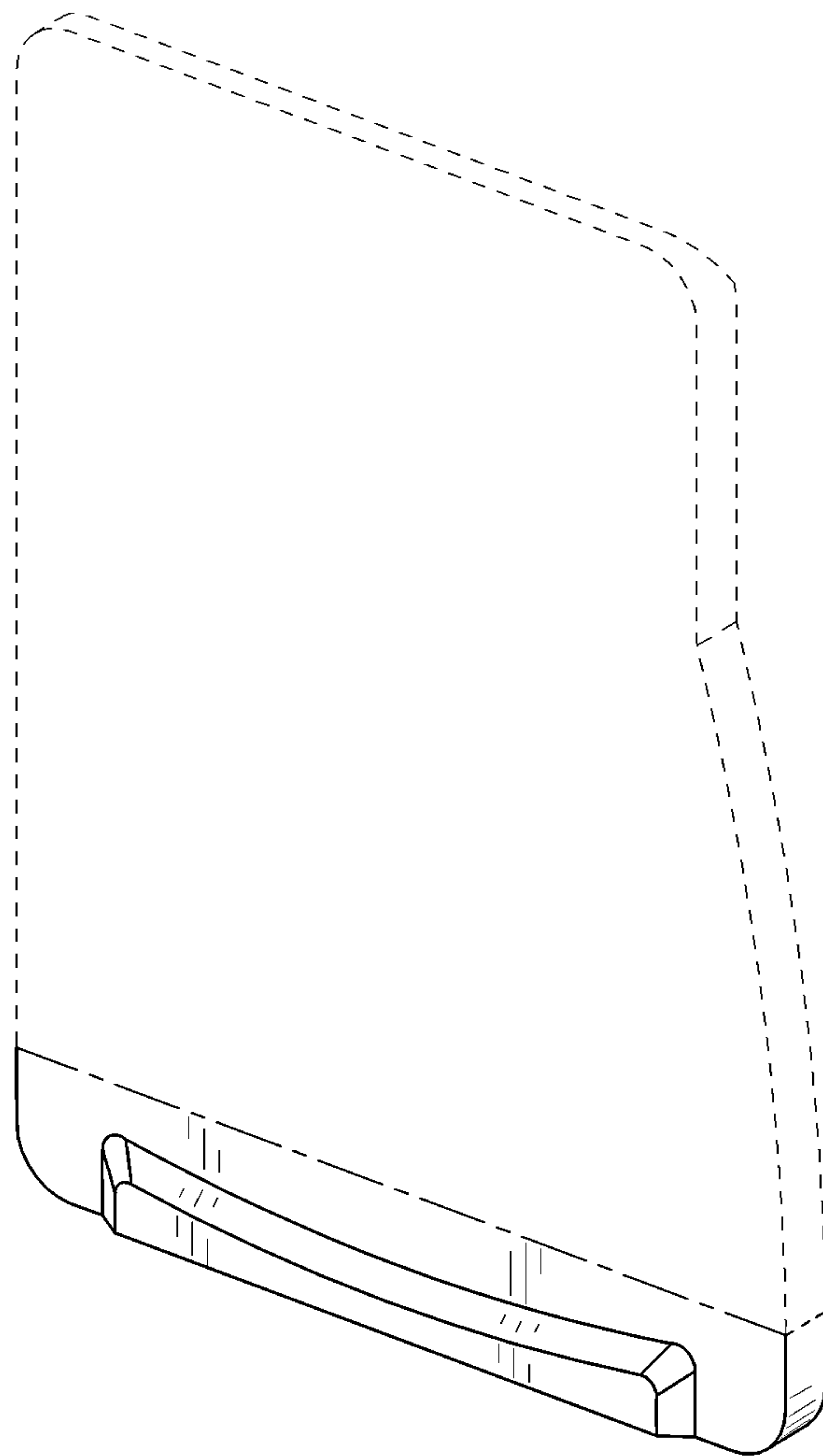

FIG. 2

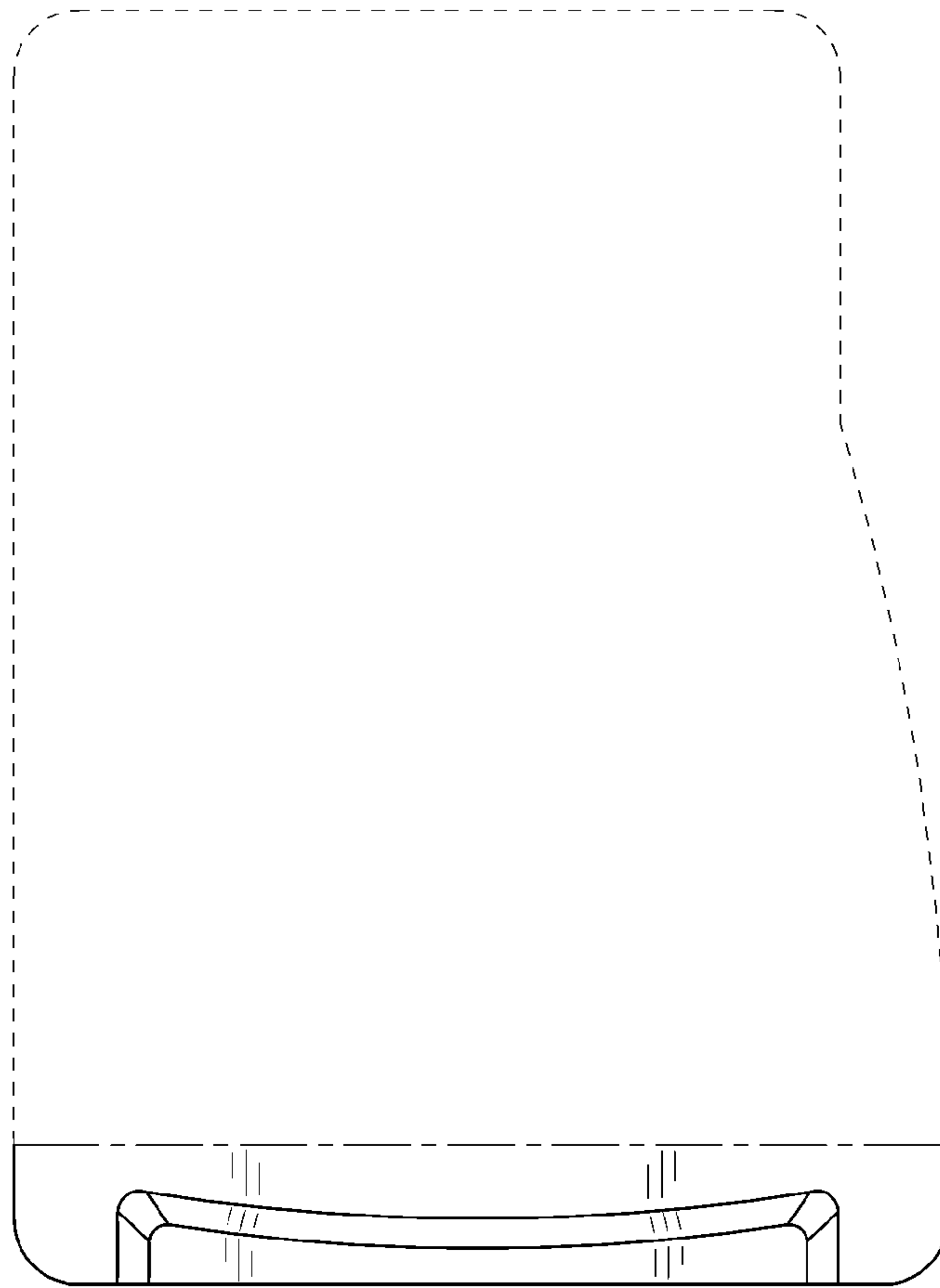

FIG. 3

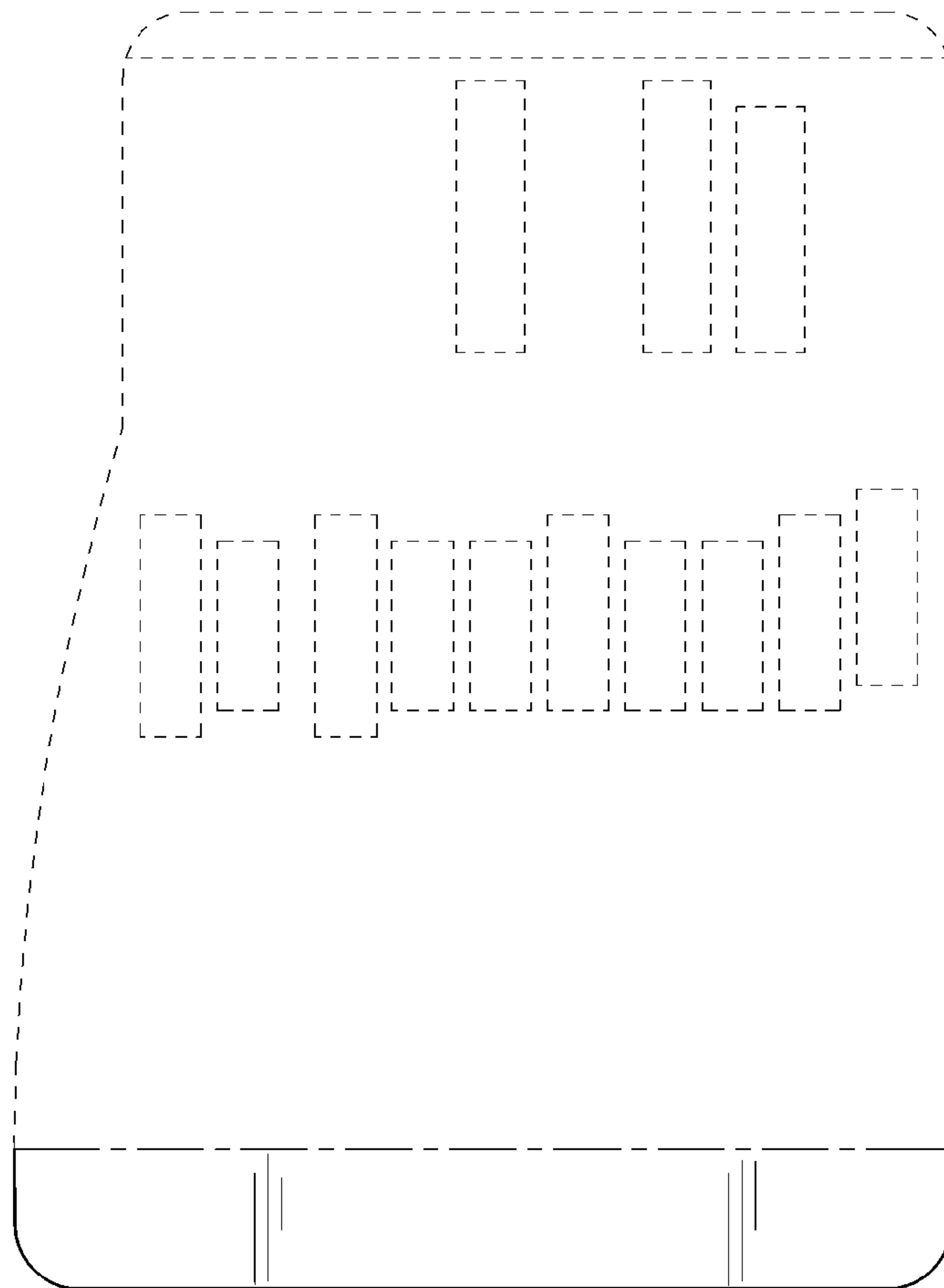

FIG. 4

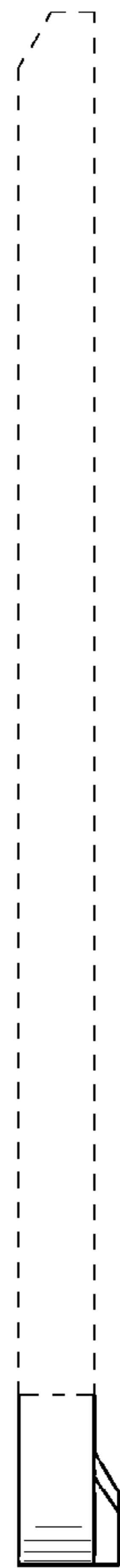

FIG. 5

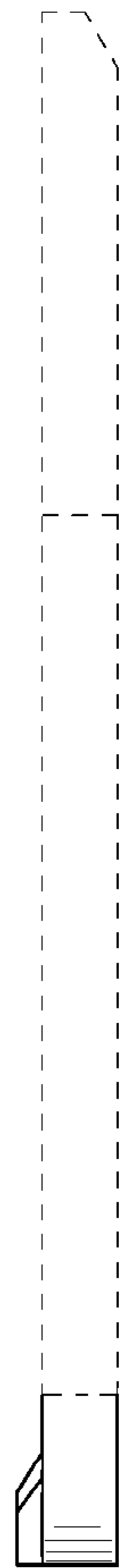

FIG. 6

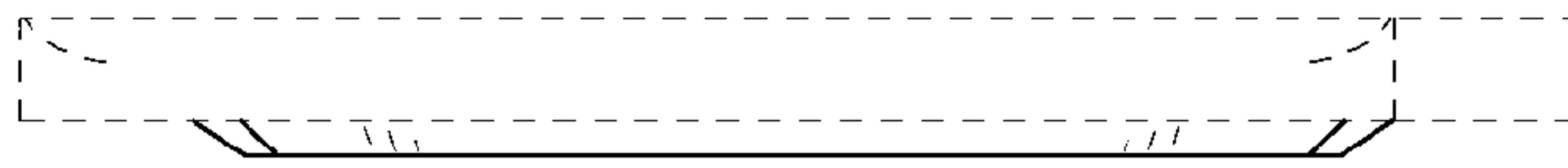

FIG. 7



FIG. 8

