



US00D735712S

(12) **United States Design Patent**  
**Nishimoto**

(10) **Patent No.:** **US D735,712 S**

(45) **Date of Patent:** **\*\* Aug. 4, 2015**

(54) **PORTABLE TERMINAL**

(71) Applicant: **Kyocera Corporation**, Kyoto-shi, Kyoto (JP)

(72) Inventor: **Keita Nishimoto**, Kawasaki (JP)

(73) Assignee: **KYOCERA Corporation**, Kyoto (JP)

(\*\*) Term: **14 Years**

(21) Appl. No.: **29/484,348**

(22) Filed: **Mar. 7, 2014**

(30) **Foreign Application Priority Data**

Dec. 18, 2013 (JP) ..... 2013-029675

(51) **LOC (10) Cl.** ..... **14-02**

(52) **U.S. Cl.**  
USPC ..... **D14/344**

(58) **Field of Classification Search**

USPC ..... D14/138 A, 138 R, 218, 240, 341, 342,  
D14/343, 344, 345, 346, 347, 358, 420, 426,  
D14/427, 496; D10/30, 31, 32, 37, 38, 39,  
D10/65, 70, 98; 368/281, 282, 294, 295,  
368/296; D11/2, 3, 4, 5; 379/433.1;  
D24/165, 167, 186

See application file for complete search history.

(56) **References Cited**

**U.S. PATENT DOCUMENTS**

D433,649 S \* 11/2000 Buettell ..... D11/200  
D455,356 S \* 4/2002 Saffer ..... D10/32  
D560,134 S \* 1/2008 Chen ..... D11/4  
D583,815 S \* 12/2008 Giovannoni ..... D14/480.3  
D653,564 S \* 2/2012 Eida ..... D10/32  
D671,858 S \* 12/2012 Cobbett et al. .... D11/3  
D677,595 S \* 3/2013 Hinskens ..... D10/128  
D688,968 S \* 9/2013 Guerrero, II ..... D11/3  
D694,662 S \* 12/2013 Buckley ..... D11/3  
D708,089 S \* 7/2014 Burbano ..... D11/6

D717,684 S \* 11/2014 Delaney ..... D11/3  
D718,167 S \* 11/2014 Yliluoma ..... D10/128  
D721,609 S \* 1/2015 Duddy ..... D11/3

**OTHER PUBLICATIONS**

Sony website page showing Smart Watch 2 SW2 Retrieved on Mar. 6, 2014 from URL [http://store.sonymobile.jp/epf05/EPF0502Init.do?shohin\\_cd=SW2](http://store.sonymobile.jp/epf05/EPF0502Init.do?shohin_cd=SW2).

Samsung website page showing Smart Freedom Retrieved on Mar. 6, 2014 from URL <http://www.samsung.com/jp/consumer/mobilephone/galaxy-gear/au/SM-V7000ZKAKDI>.

\* cited by examiner

*Primary Examiner* — Barbara Fox

*Assistant Examiner* — Chelsea Sealey

(74) *Attorney, Agent, or Firm* — Studebaker & Brackett PC

(57) **CLAIM**

The ornamental design for portable terminal, as shown and described.

**DESCRIPTION**

FIG. 1 is a front perspective view of a portable terminal showing my new design;

FIG. 2 is a rear perspective view thereof;

FIG. 3 is a front view thereof;

FIG. 4 is a rear view thereof;

FIG. 5 is a left side view thereof;

FIG. 6 is a right side view thereof;

FIG. 7 is a top plan view thereof;

FIG. 8 is a bottom view thereof;

FIG. 9 is a rear view showing a state where a mounting member is attached to the portable terminal;

FIG. 10 is a right side view thereof;

FIG. 11 is a bottom view thereof;

FIG. 12 is a front perspective view showing a state where the mounting member is detached from the portable terminal; and,

FIG. 13 is a rear perspective view thereof.

The broken lines represent portions of the portable terminal that form no part of the claimed design.

**1 Claim, 11 Drawing Sheets**

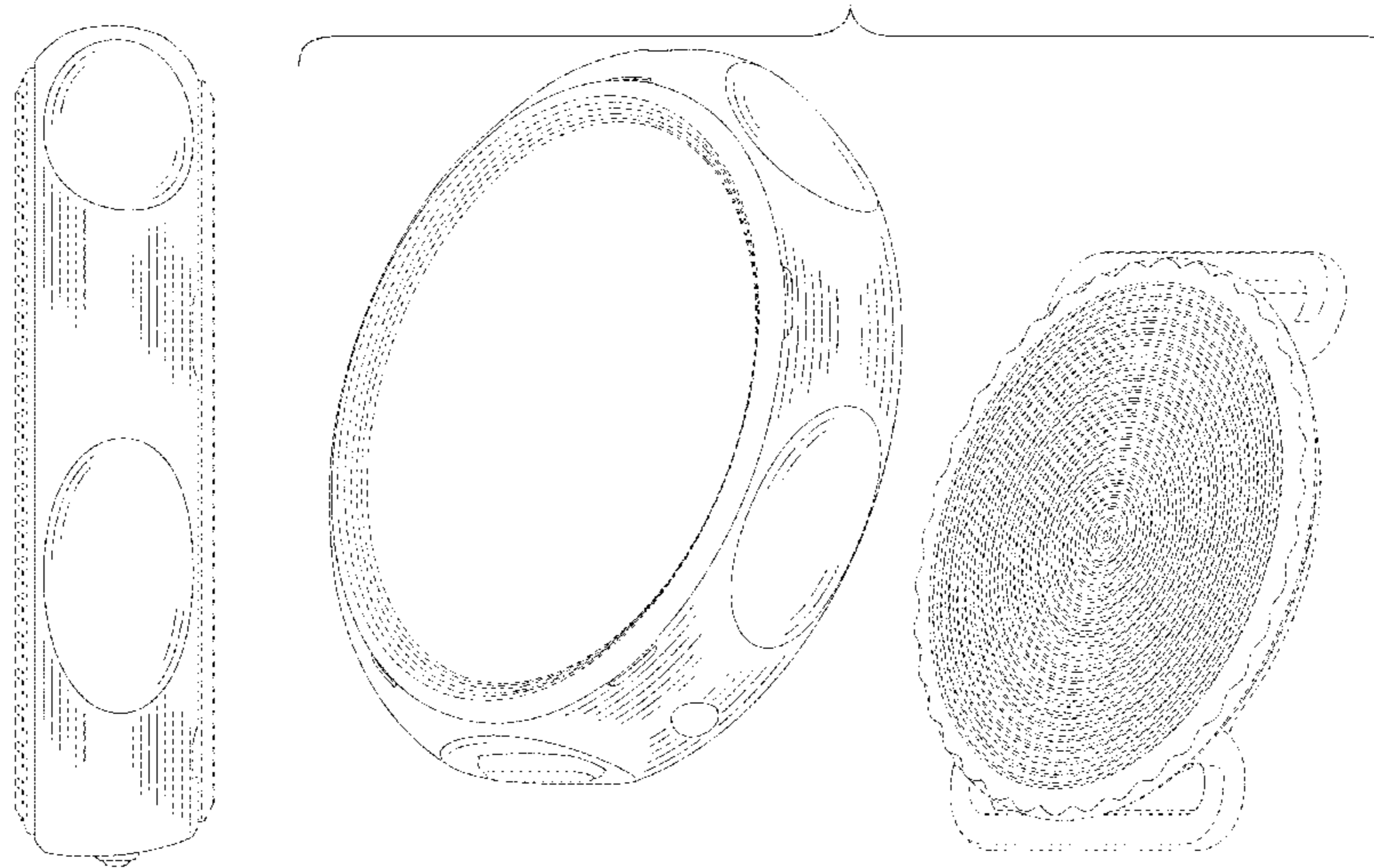

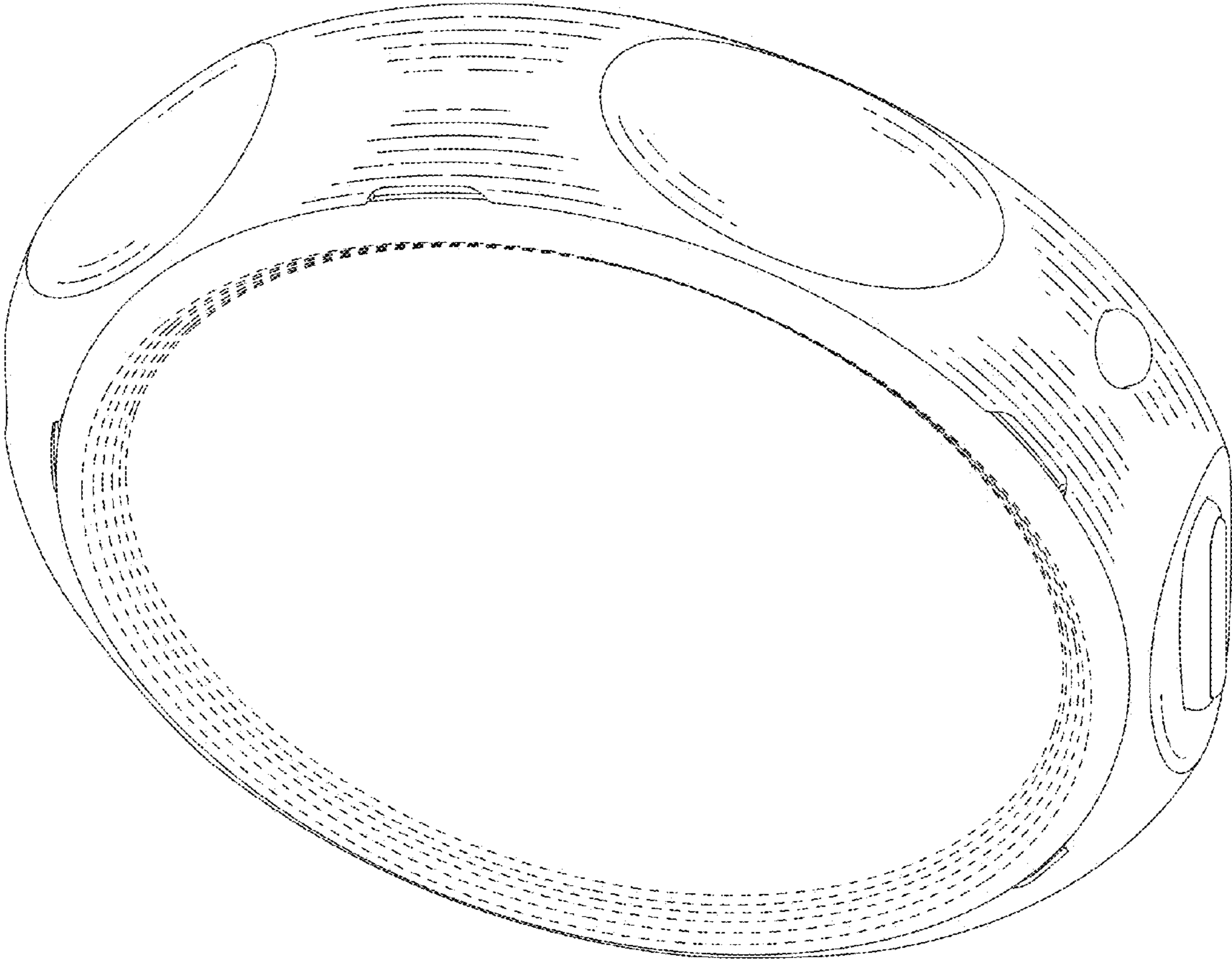

FIG.1

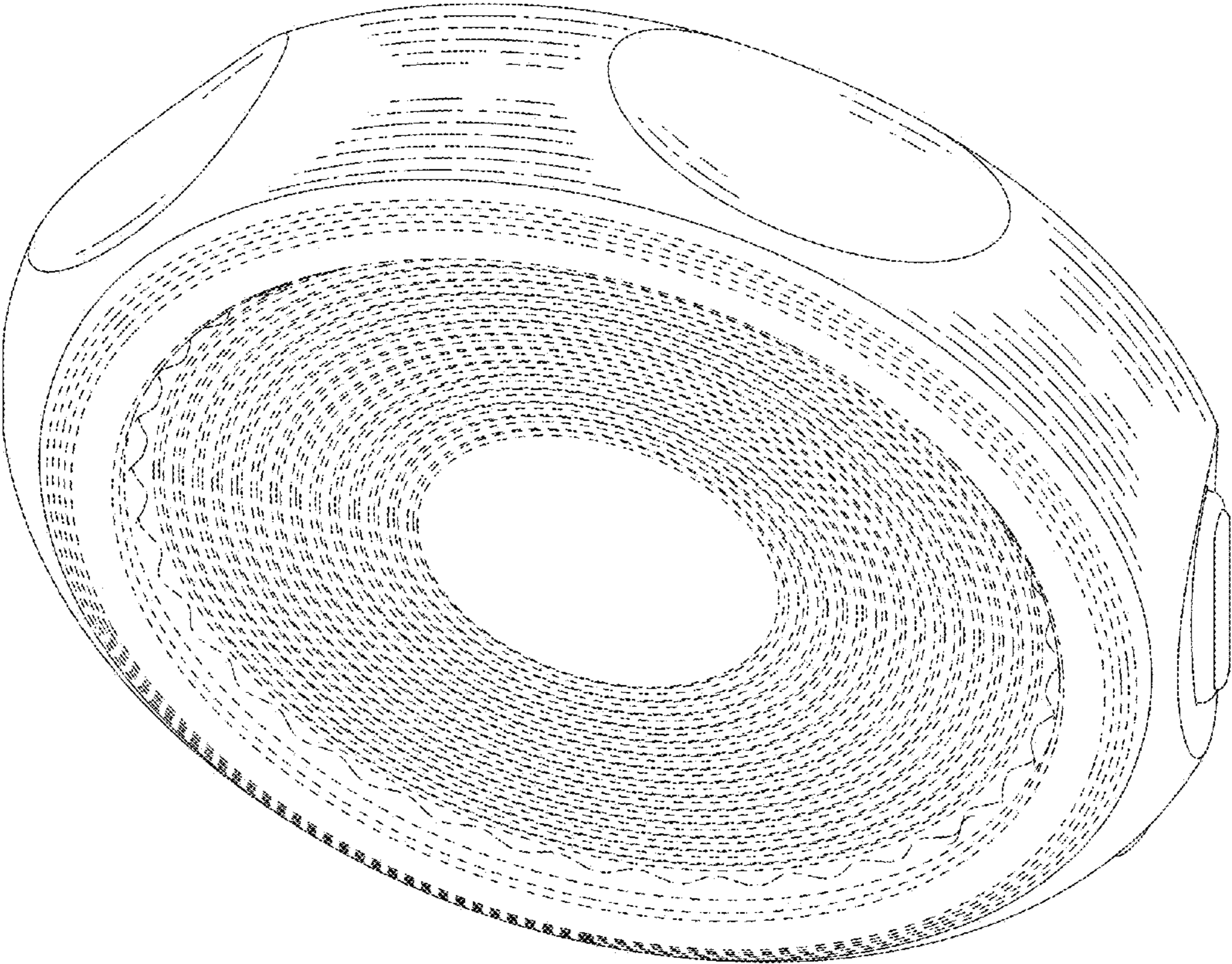

FIG.2

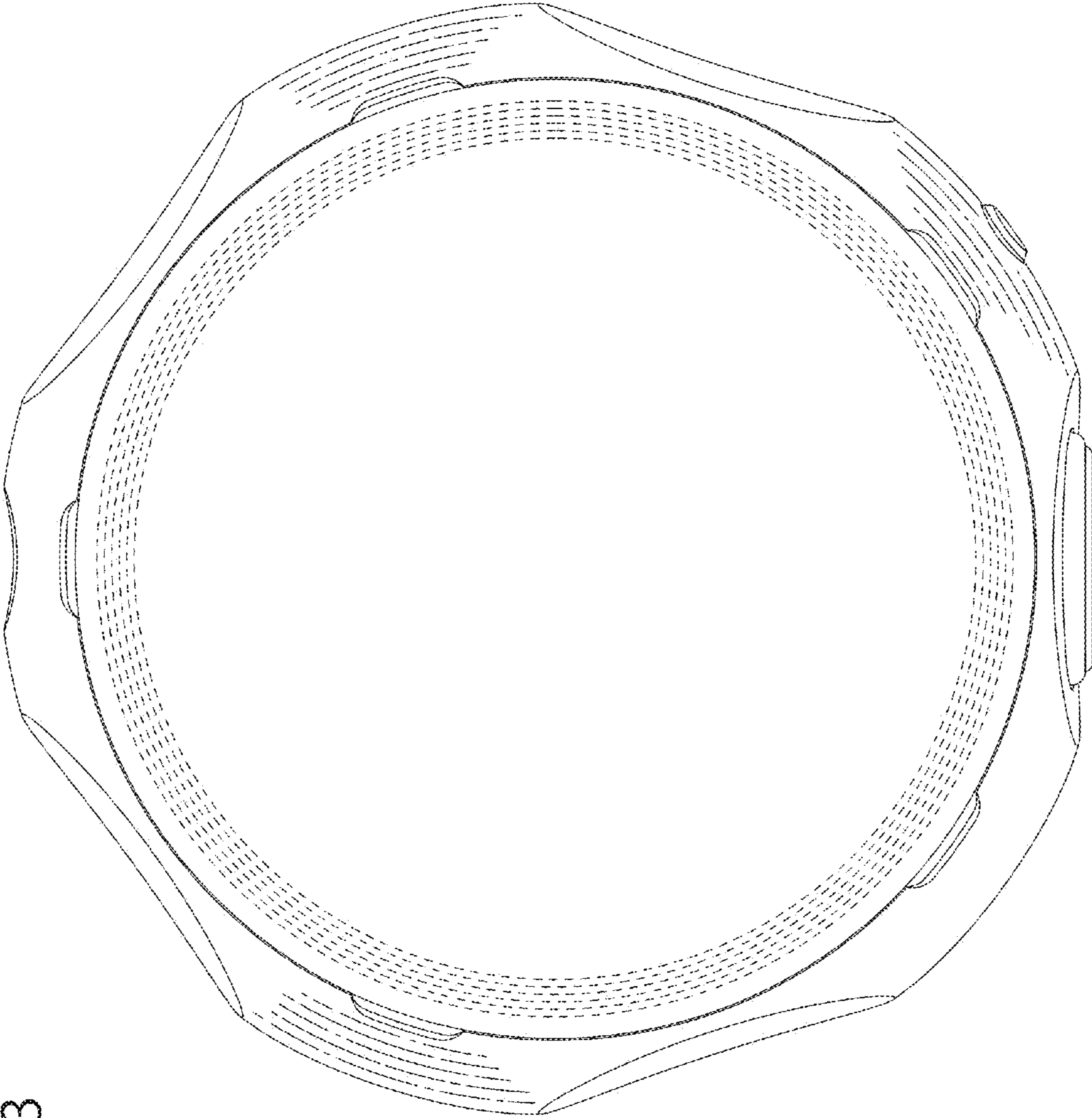

FIG.3

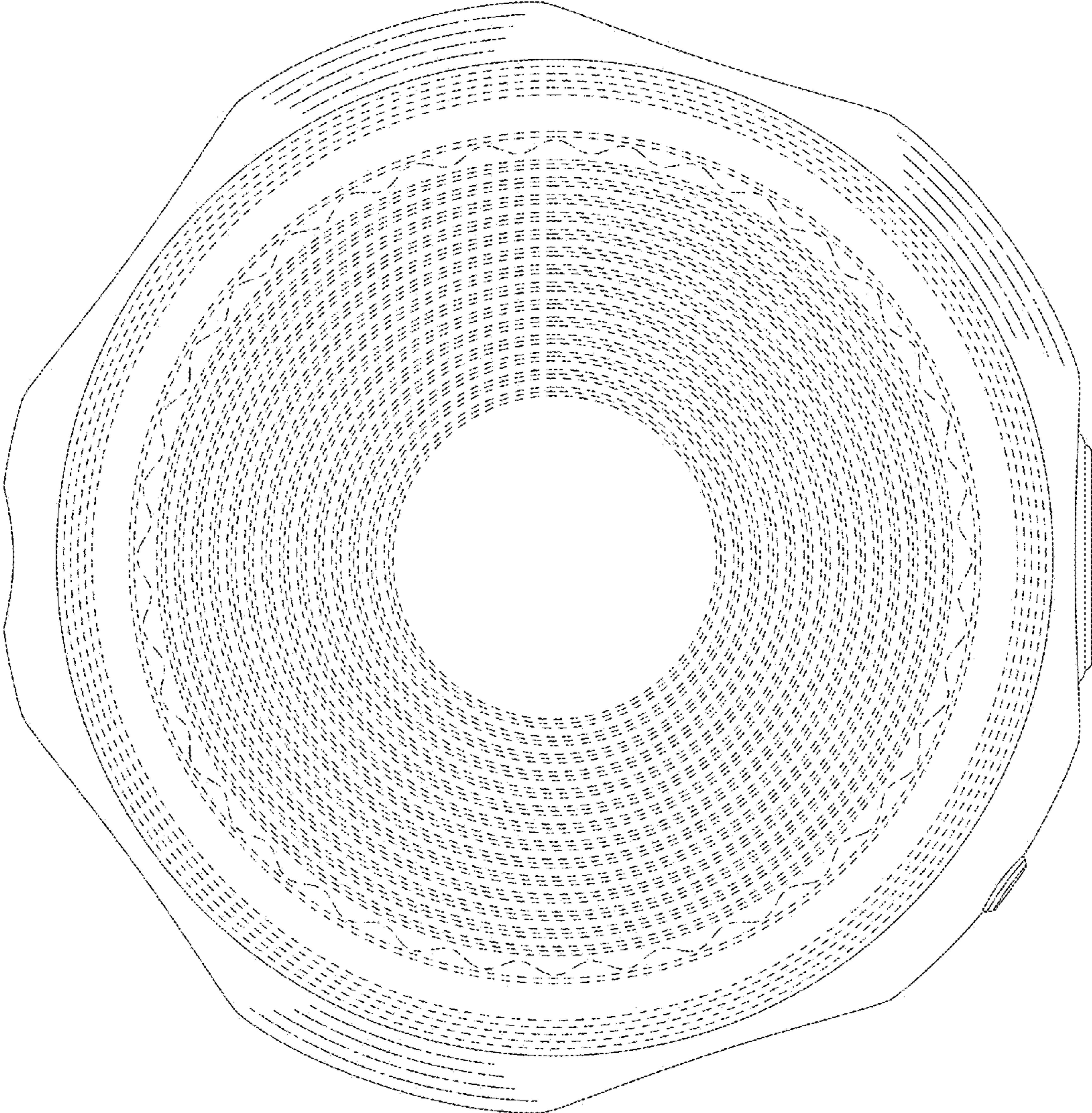

FIG.4

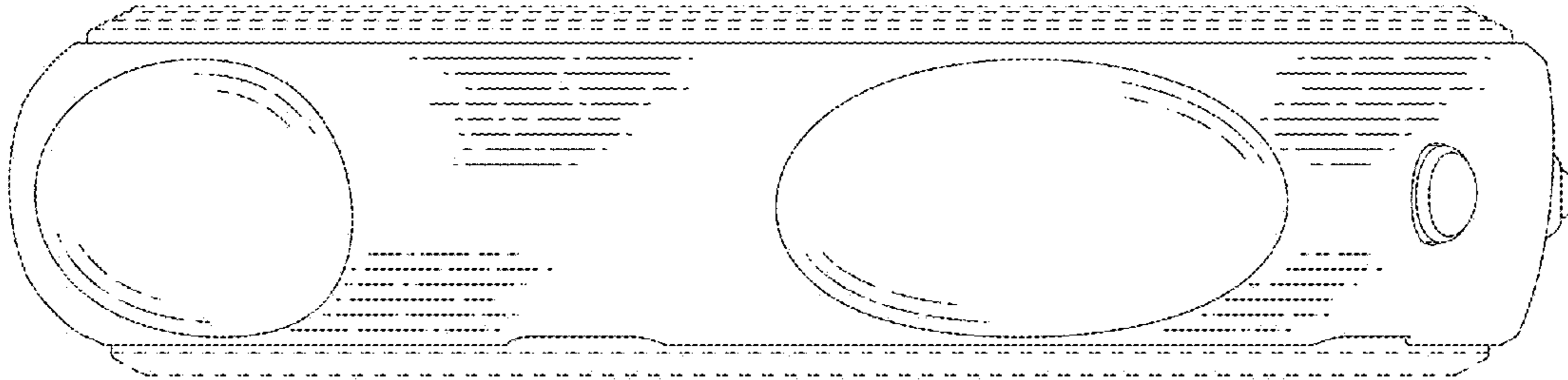

FIG.6

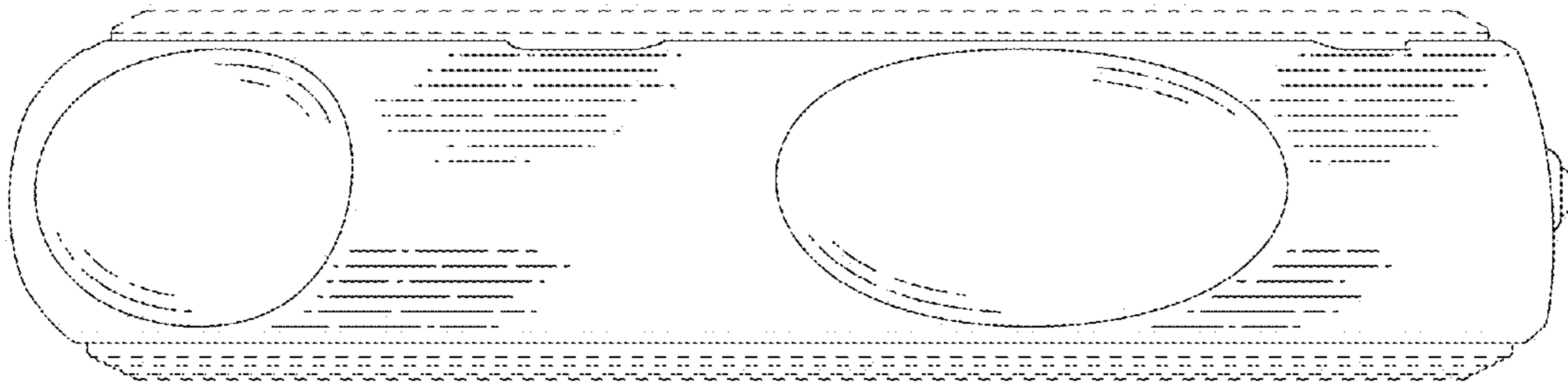

FIG.5

FIG.7

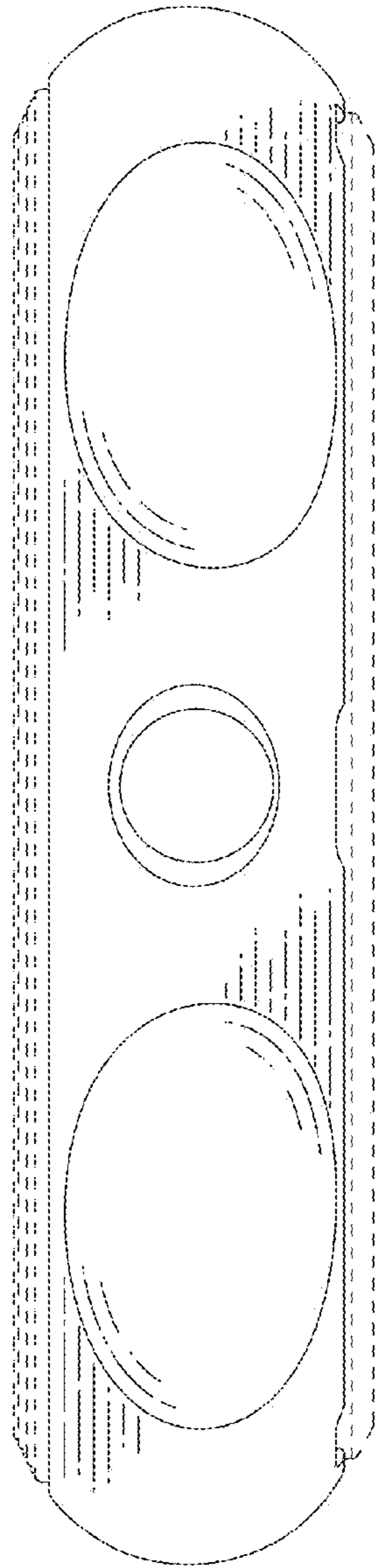
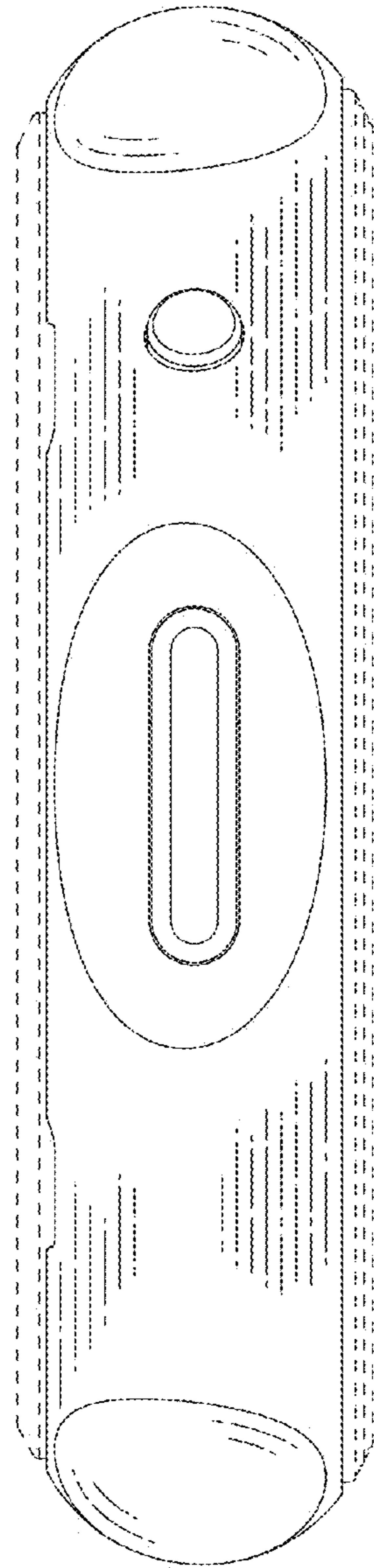

FIG.8



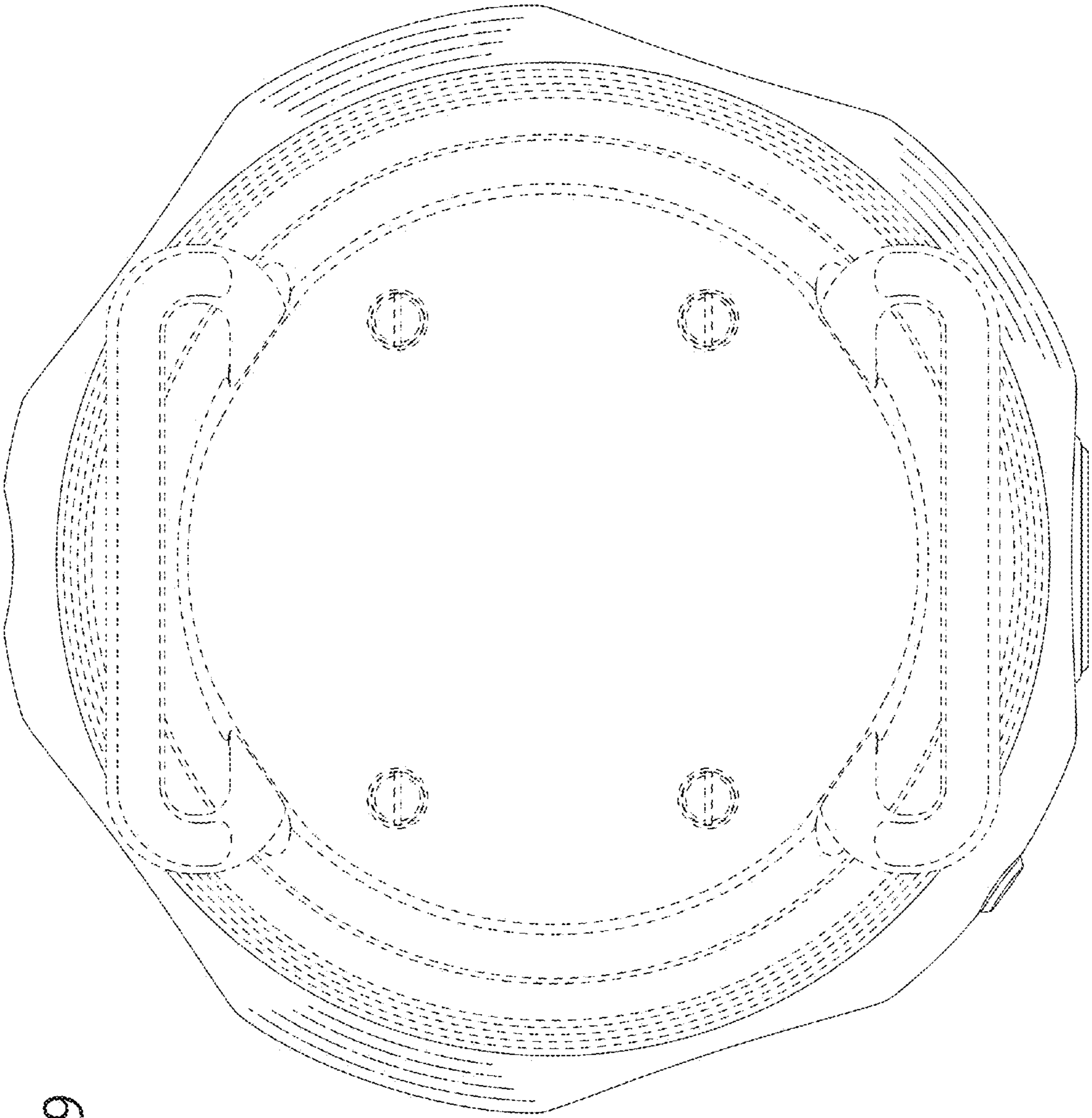

FIG.9



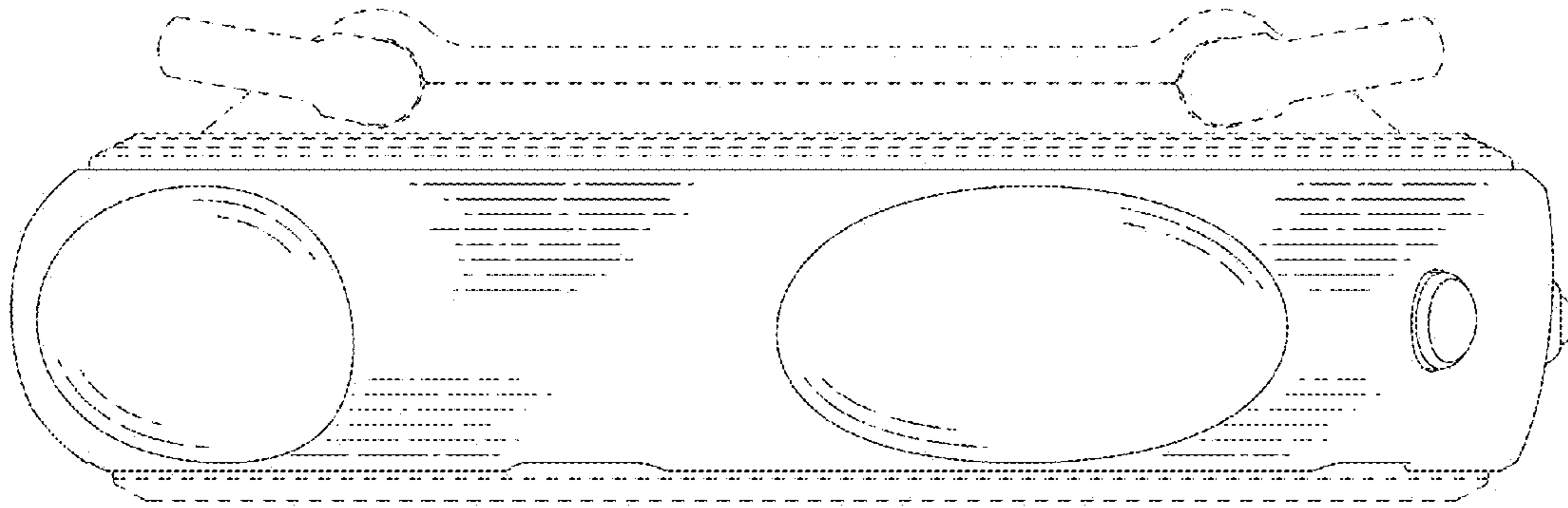
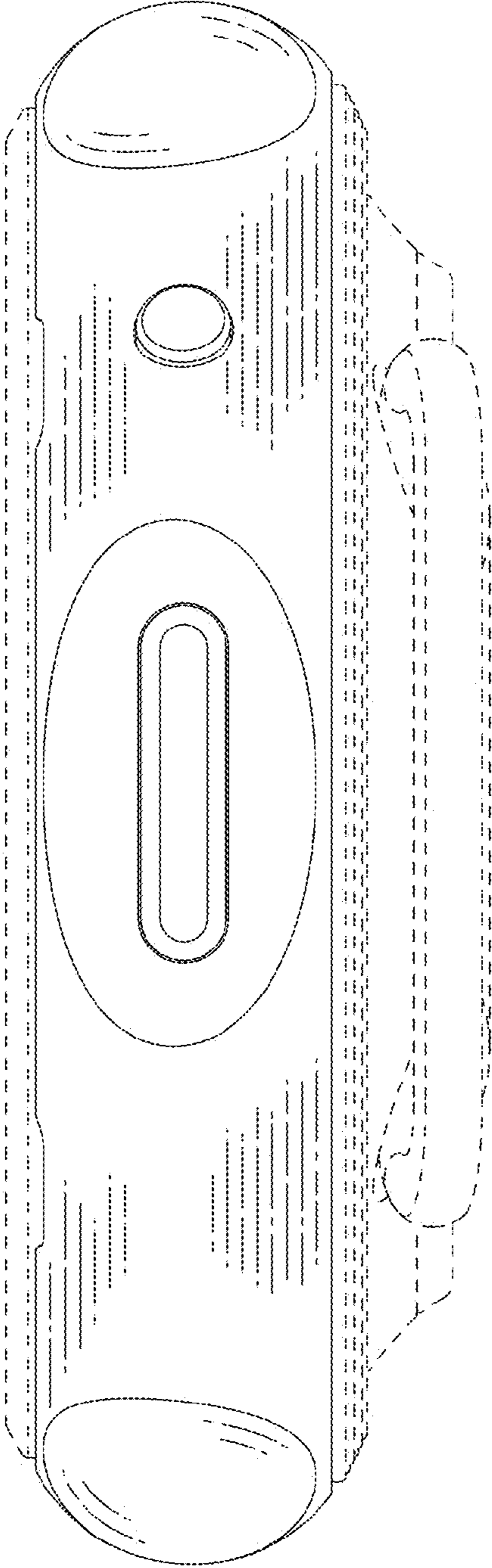

FIG.10

FIG.11



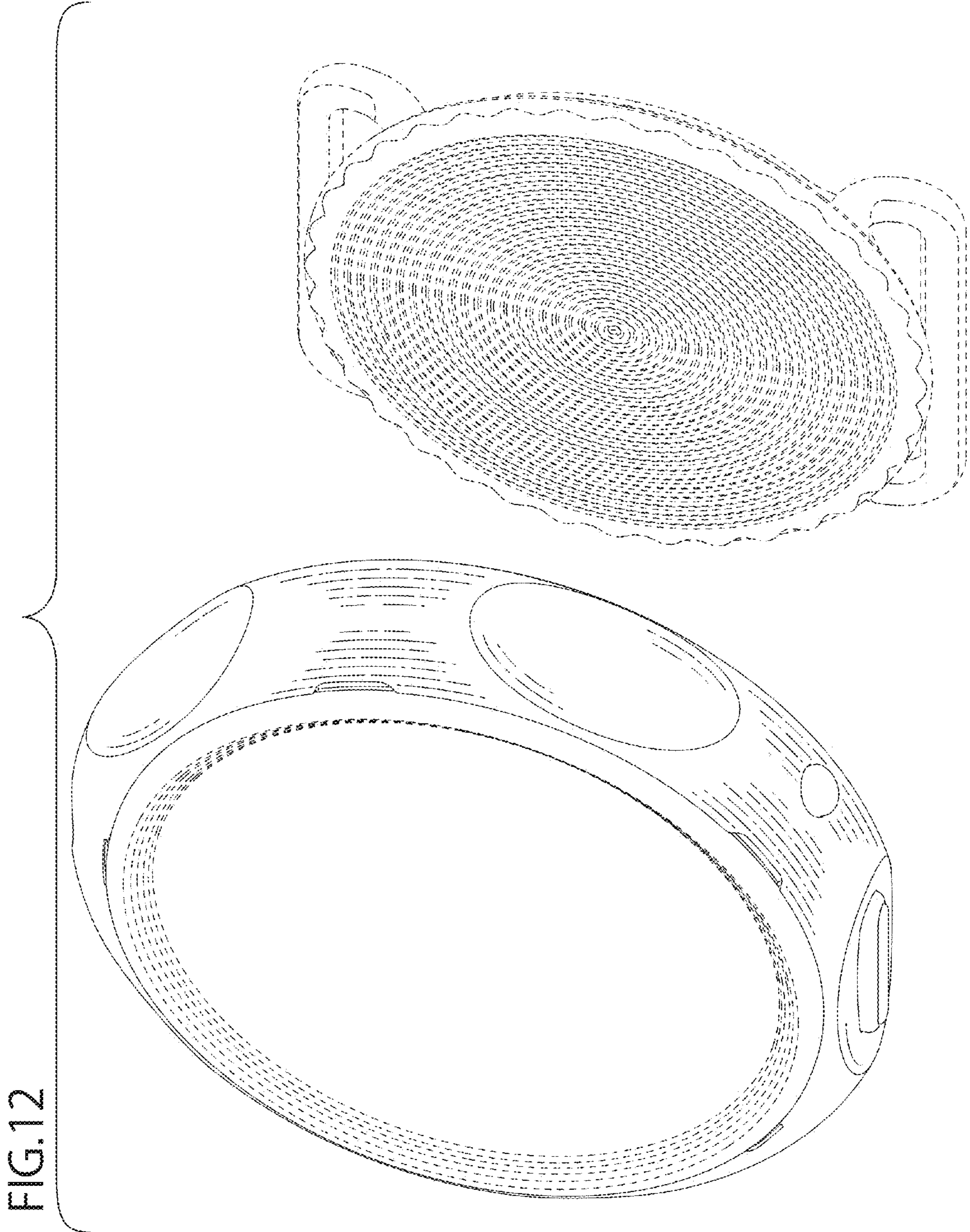

FIG. 12

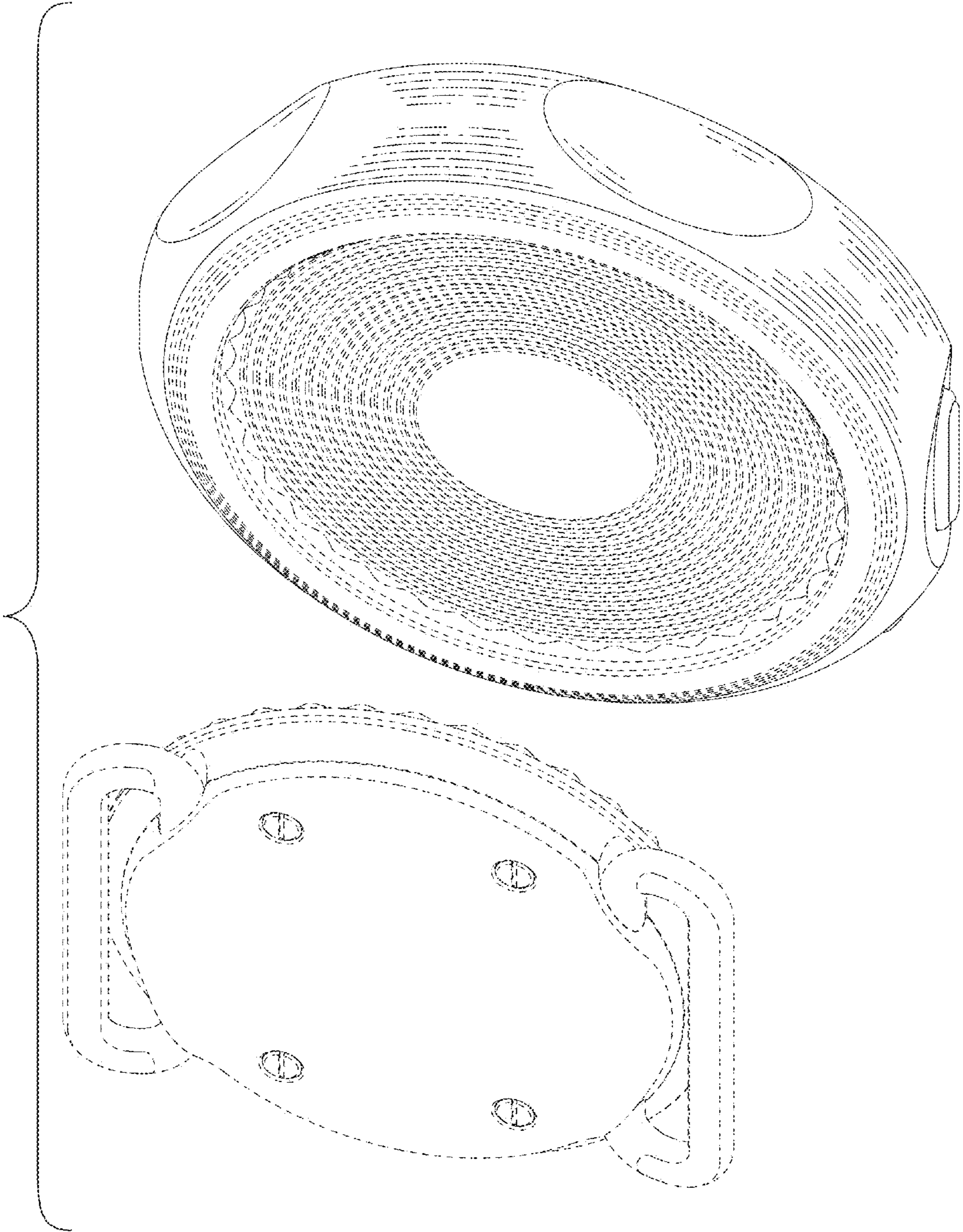

FIG.13