



US00D735675S

(12) **United States Design Patent**
Yoshioka

(10) **Patent No.:** **US D735,675 S**

(45) **Date of Patent:** **** Aug. 4, 2015**

(54) **CONNECTOR**

(71) Applicant: **Panasonic Intellectual Property Management Co., Ltd.**, Osaka-shi, Osaka (JP)

(72) Inventor: **Kohsuke Yoshioka**, Mie (JP)

(73) Assignee: **PANASONIC INTELLECTUAL PROPERTY MANAGEMENT CO., LTD.**, Osaka (JP)

(**) Term: **14 Years**

(21) Appl. No.: **29/503,650**

(22) Filed: **Sep. 29, 2014**

(51) **LOC (10) Cl.** **13-03**

(52) **U.S. Cl.**
USPC **D13/147**

(58) **Field of Classification Search**
USPC D13/147, 154, 184, 199
See application file for complete search history.

(56) **References Cited**

U.S. PATENT DOCUMENTS

D603,798	S	*	11/2009	Obikane et al.	D13/147
D642,986	S	*	8/2011	Nishimura et al.	D13/147
D684,120	S	*	6/2013	Miyazaki et al.	D13/147
D687,383	S	*	8/2013	Miyazaki et al.	D13/147
D703,146	S	*	4/2014	Takenaga et al.	D13/147

D722,973	S	*	2/2015	Miyazaki	D13/147
D722,974	S	*	2/2015	Ueda et al.	D13/147
D723,471	S	*	3/2015	Miyazaki	D13/147

* cited by examiner

Primary Examiner — Daniel Bui

(74) *Attorney, Agent, or Firm* — Brinks Gilson & Lione

(57) **CLAIM**

I claim the ornamental design for a connector, as shown and described.

DESCRIPTION

FIG. 1 is a top and front perspective view of a connector showing my new design;
 FIG. 2 is a top and rear perspective view thereof;
 FIG. 3 is a bottom and front perspective view thereof;
 FIG. 4 is a top view thereof;
 FIG. 5 is a bottom view thereof;
 FIG. 6 is a front view thereof;
 FIG. 7 is a rear view thereof;
 FIG. 8 is a first side view thereof;
 FIG. 9 is a second side view thereof;
 FIG. 10 is an enlarged cross-section view taken along the line 10-10 of FIG. 4; and,
 FIG. 11 is an enlarged cross-section view taken along the line 11-11 of FIG. 4.

The broken lines shown represent unclaimed subject matter and form no part of the claimed design. Additionally, the unevenly broken lines in the drawings define the limits of the claimed design.

1 Claim, 11 Drawing Sheets

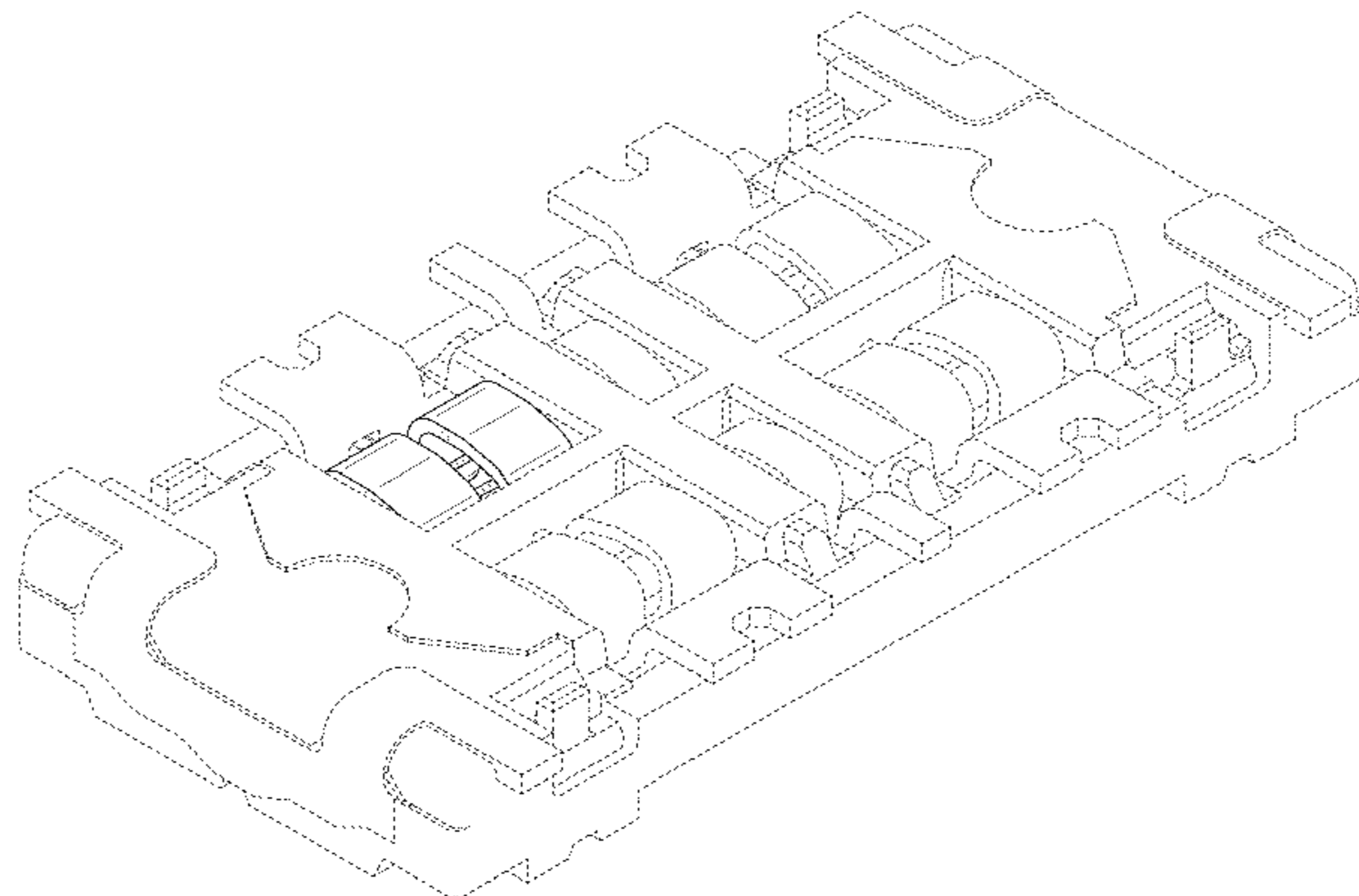
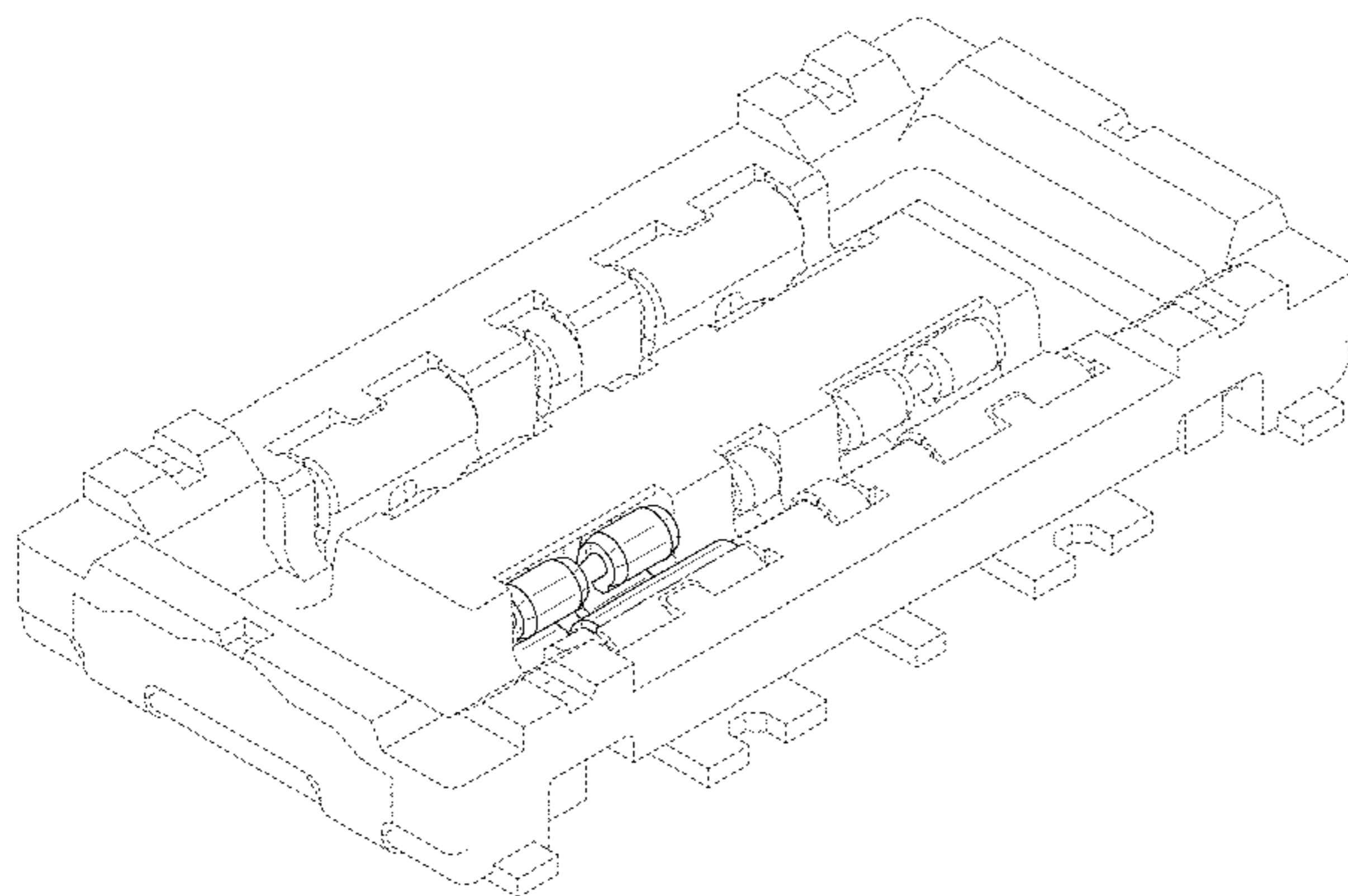

FIG. 1

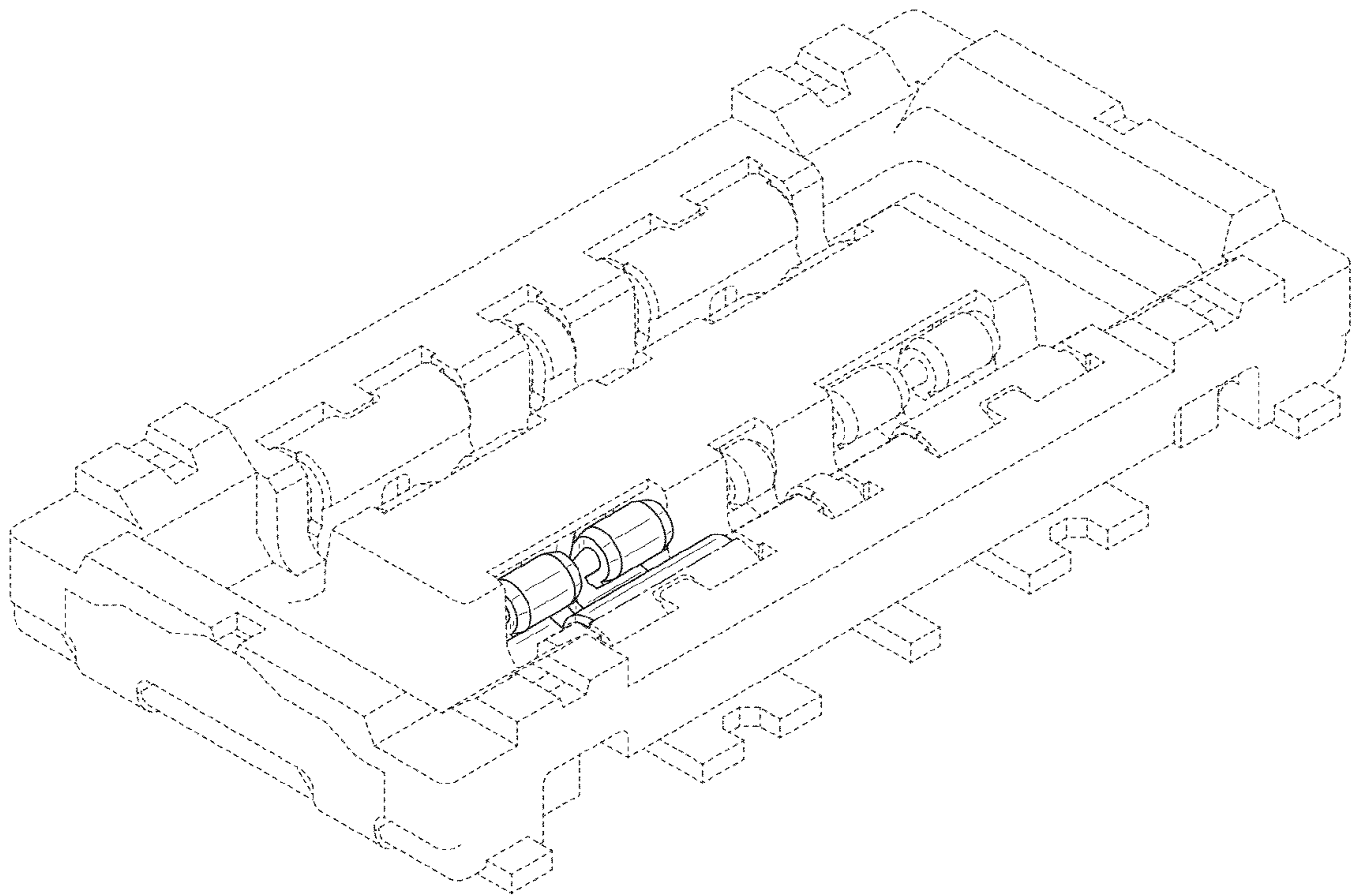

FIG.2

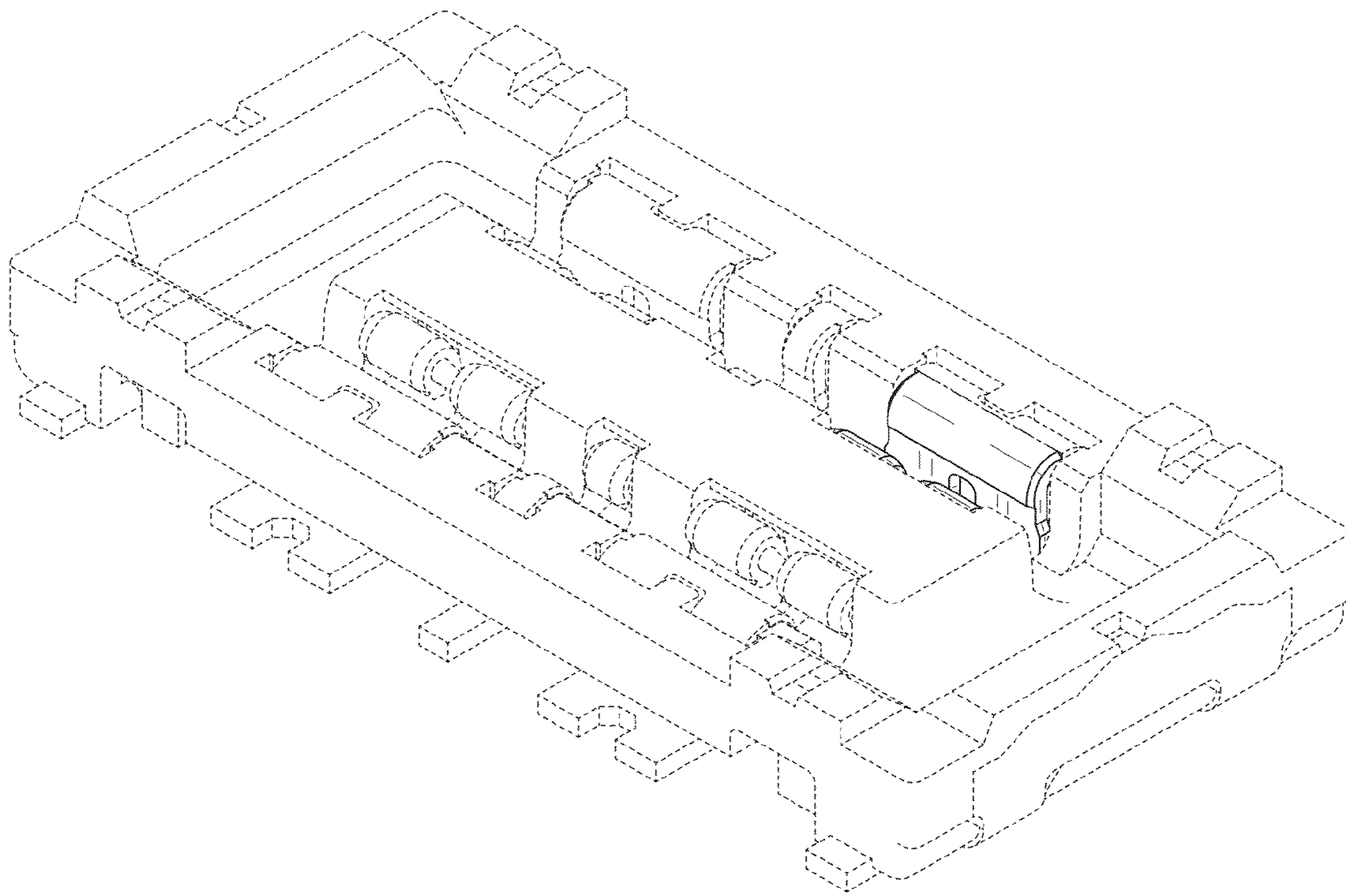

FIG.3

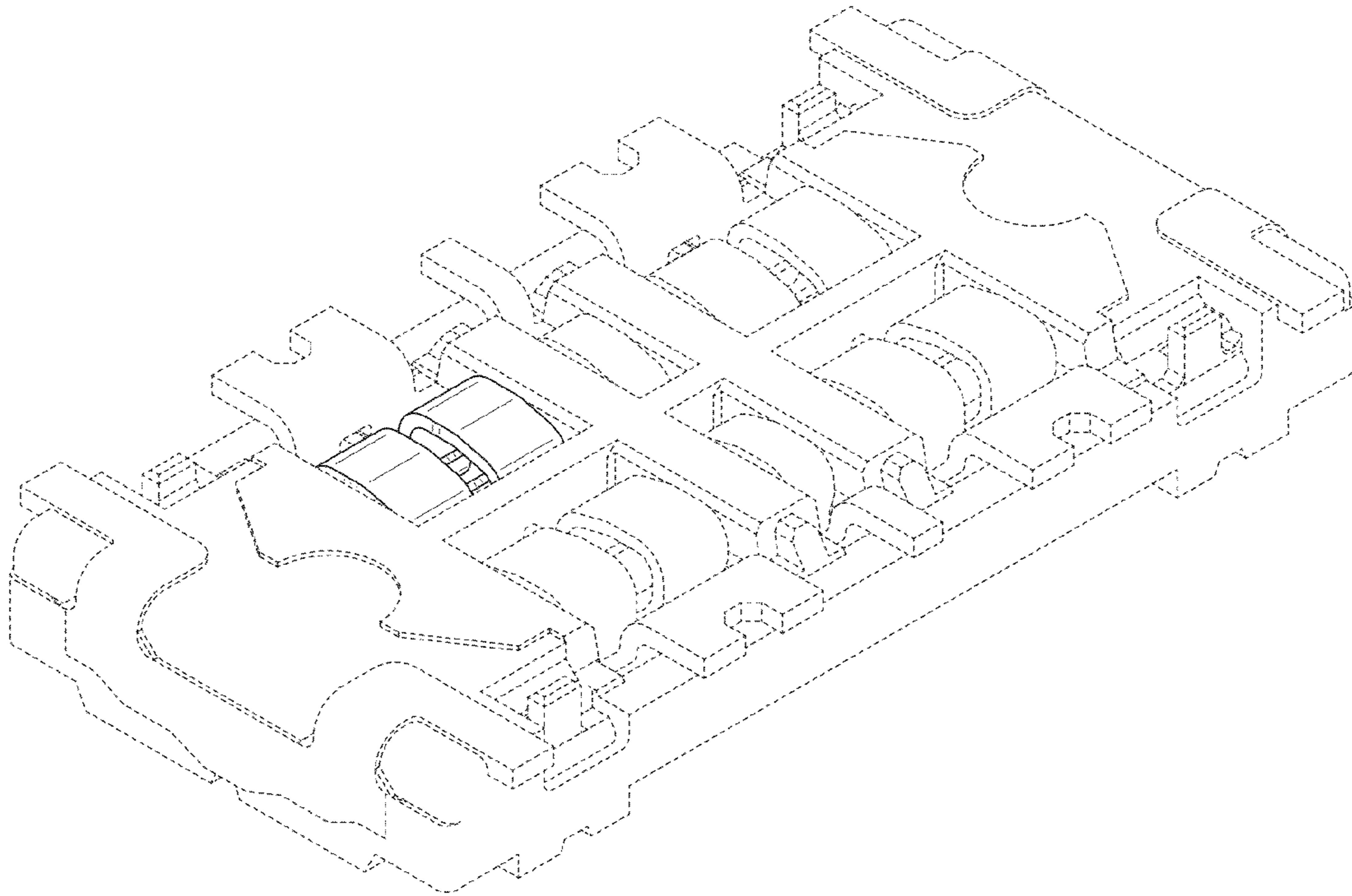

FIG.4

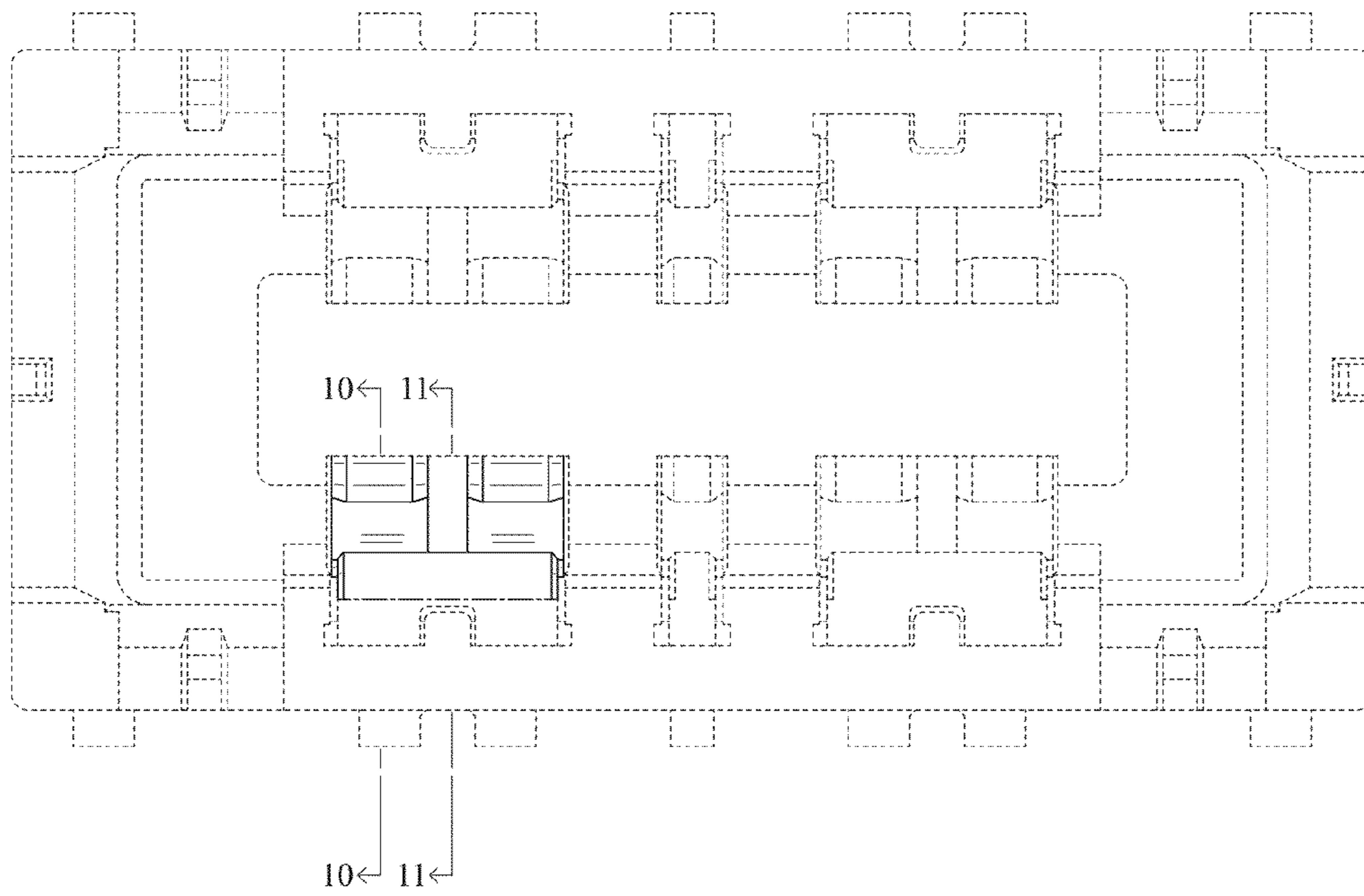

FIG.5

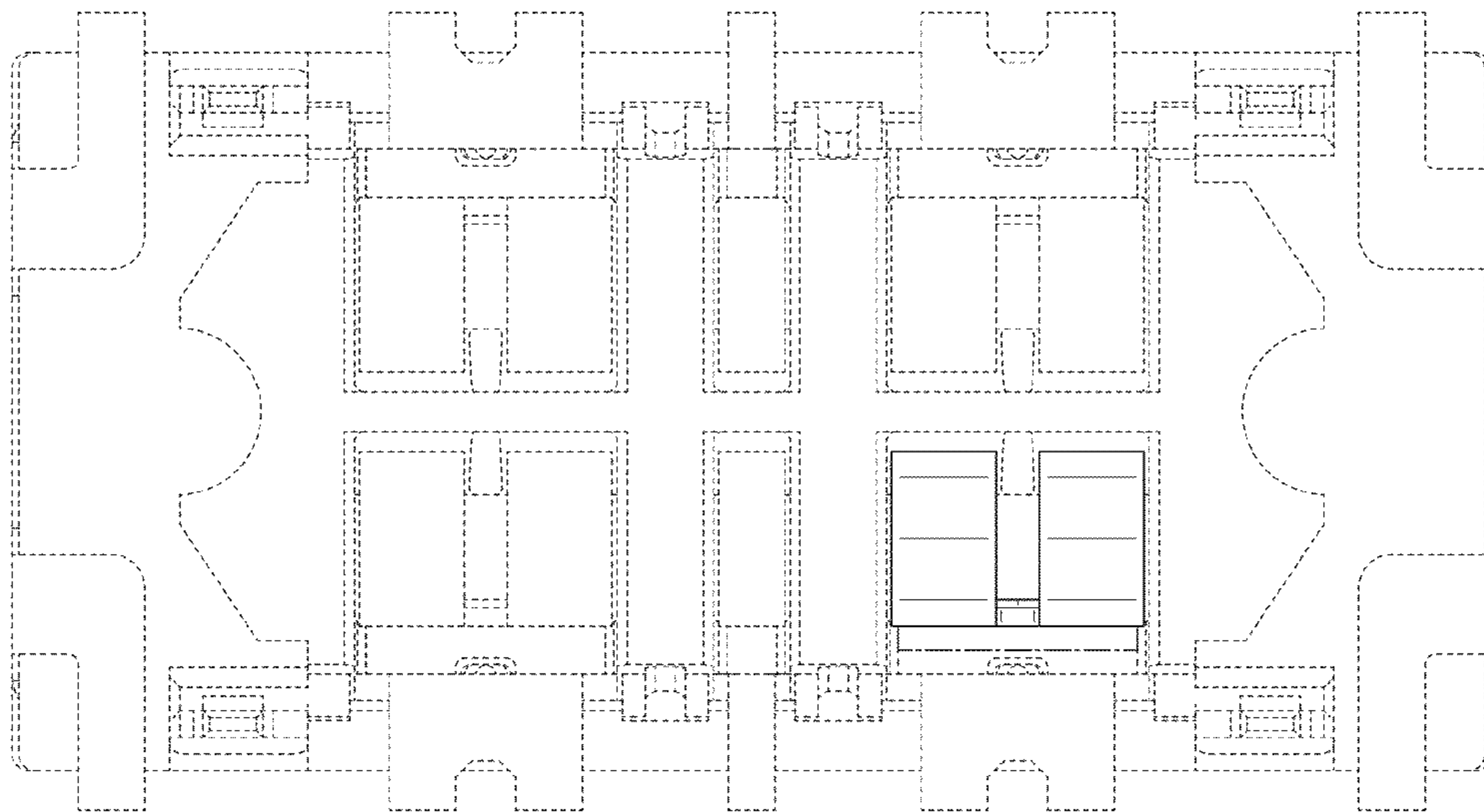

FIG.6

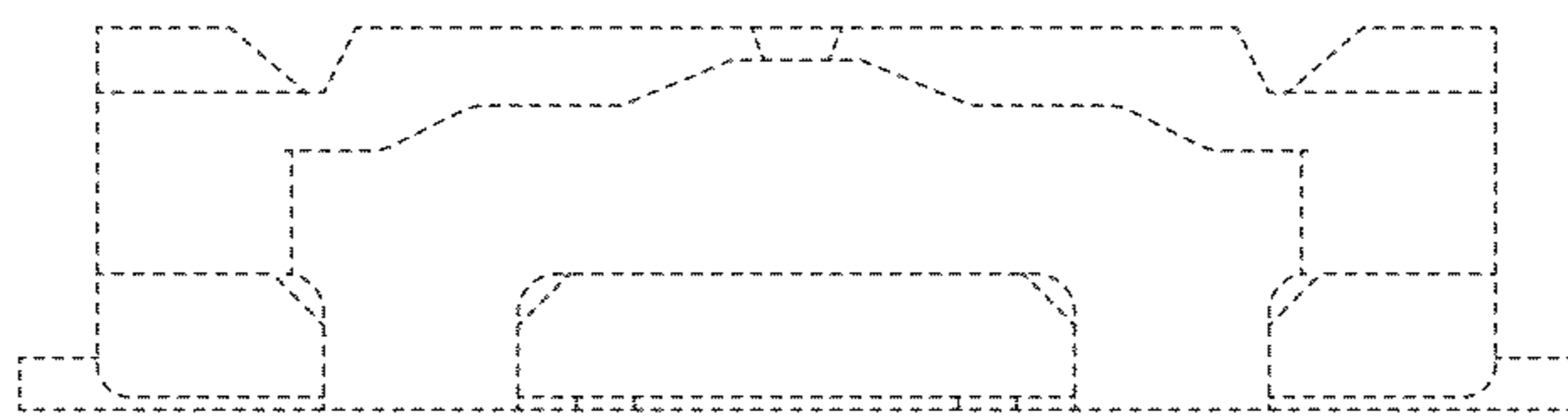

FIG.7

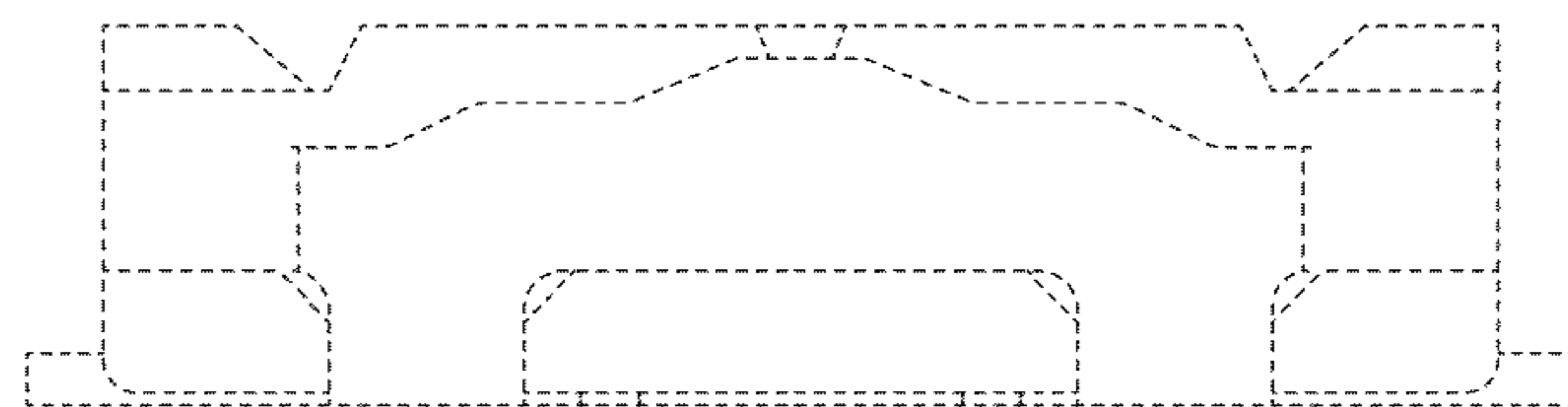

FIG.8

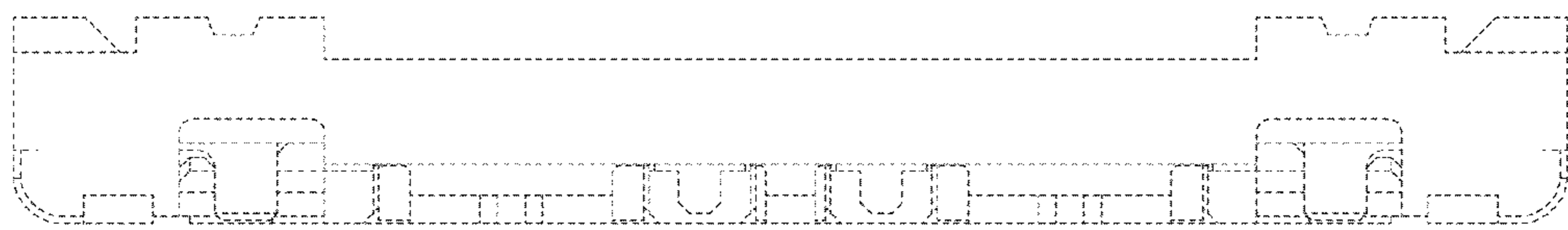

FIG.9

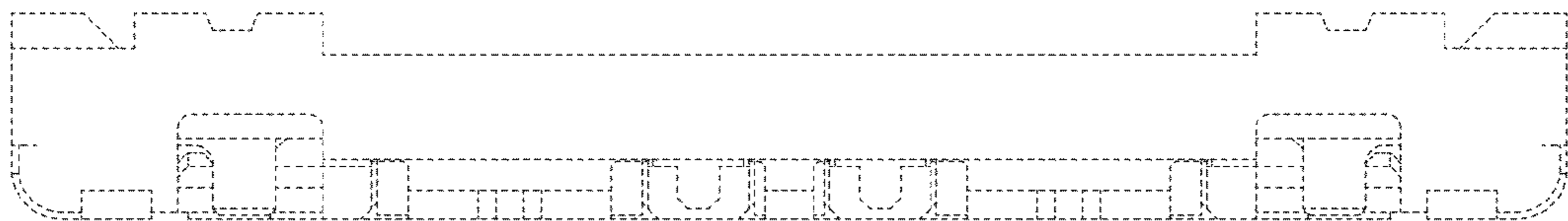

FIG. 10

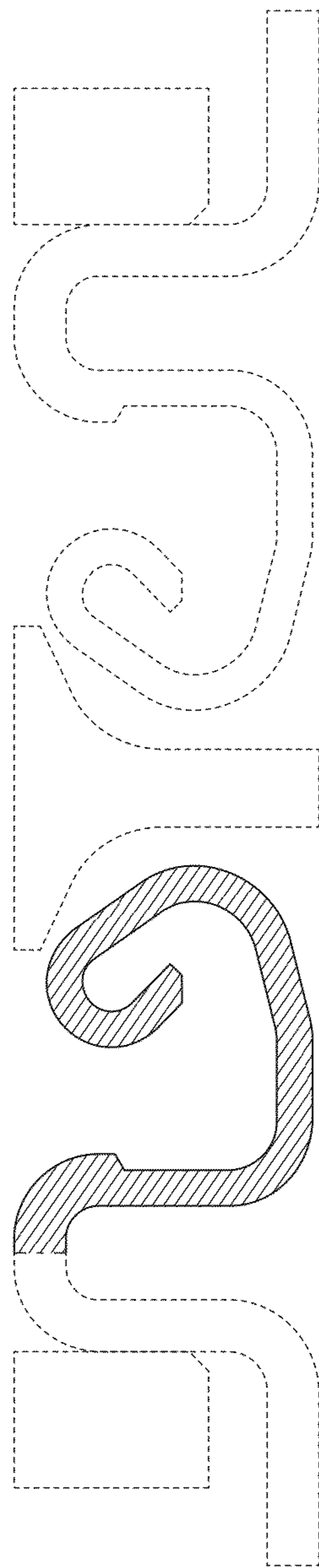

FIG. 11

