



US00D735550S

(12) **United States Design Patent**  
**Seeds et al.**

(10) **Patent No.:** **US D735,550 S**

(45) **Date of Patent:** **\*\* Aug. 4, 2015**

(54) **HATCHET**

(71) Applicant: **Fiskars Brands, Inc.**, Madison, WI (US)

(72) Inventors: **Darrin Seeds**, Vancouver, WA (US); **Jeff Freeman**, Tigard, OR (US); **Frank Rossi**, Hillsboro, OR (US)

(73) Assignee: **FISKARS BRANDS, INC.**, Madison, WI (US)

(\*\*) Term: **14 Years**

(21) Appl. No.: **29/448,459**

(22) Filed: **Mar. 12, 2013**

(51) **LOC (10) Cl.** ..... **08-02**

(52) **U.S. Cl.**  
USPC ..... **D8/80**

(58) **Field of Classification Search**  
USPC ..... D8/75-81, 98-99, 107, 303; D22/117,  
D22/118; 81/489-492  
CPC ..... B25F 1/00; B25F 1/006; B25F 1/02;  
B25G 1/01; B25G 1/08; B25G 3/24; B26B  
3/06; B26B 23/00; B26B 27/00  
See application file for complete search history.

(56) **References Cited**

**U.S. PATENT DOCUMENTS**

2,329,424 A 9/1943 Steiner  
2,793,664 A 5/1957 Warrington, Sr.

(Continued)

**OTHER PUBLICATIONS**

Bear Grylls Survival Hatchet. Snagged Dec. 10, 2014 at <https://www.google.com/search?q=Fiskars+Gerber+Hatchet> . . . \*

(Continued)

*Primary Examiner* — Philip S Hyder

*Assistant Examiner* — Roselynnne Cody

(74) *Attorney, Agent, or Firm* — Foley & Lardner LLP

(57) **CLAIM**

We claim the ornamental design for a hatchet, as shown and described.

**DESCRIPTION**

FIG. 1 is a front top perspective view of the claimed design according to one embodiment;

FIG. 2 is a left side view of the claimed design of FIG. 1;

FIG. 3 is a right side view of the claimed design of FIG. 1;

FIG. 4 is a front view of the claimed design of FIG. 1;

FIG. 5 is a rear view of the claimed design of FIG. 1;

FIG. 6 is a top view of the claimed design of FIG. 1;

FIG. 7 is a bottom view of the claimed design of FIG. 1;

FIG. 8 is a rear top perspective view of the claimed design of FIG. 1;

FIG. 9 is a front top perspective view of the claimed design according to another embodiment;

FIG. 10 is a left side view of the claimed design of FIG. 9;

FIG. 11 is a right side view of the claimed design of FIG. 9;

FIG. 12 is a front view of the claimed design of FIG. 9;

FIG. 13 is a rear view of the claimed design of FIG. 9;

FIG. 14 is a top view of the claimed design of FIG. 9;

FIG. 15 is a bottom view of the claimed design of FIG. 9; and,

FIG. 16 is a rear top perspective view of the claimed design of FIG. 9.

The broken lines in the drawings are for purposes of illustrating unclaimed portions of the design.

**1 Claim, 8 Drawing Sheets**

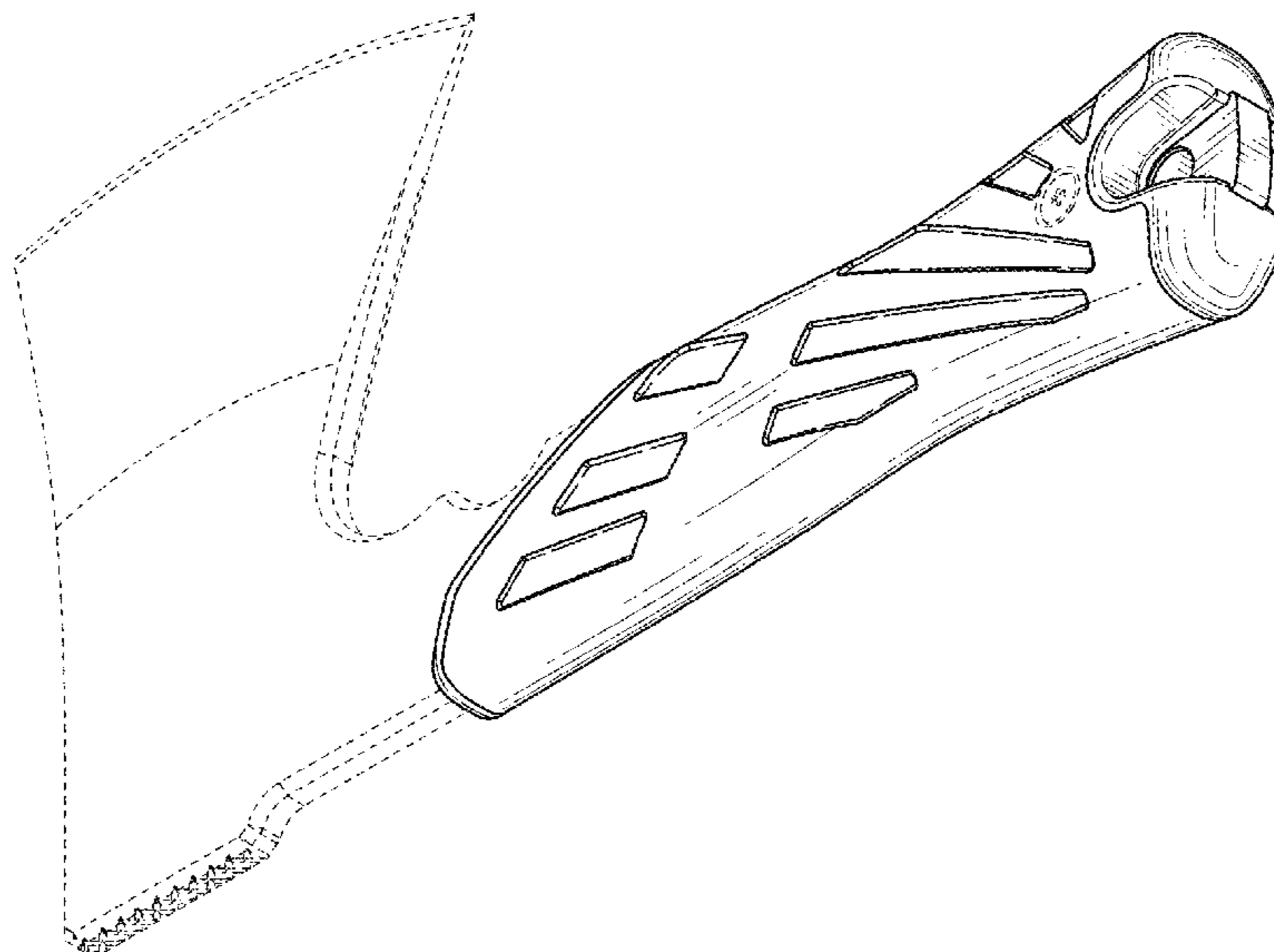

(56)

**References Cited**

U.S. PATENT DOCUMENTS

2,989,100 A 6/1961 Burdis et al.  
 4,106,539 A 8/1978 Petrich  
 D278,967 S 5/1985 Hewitt  
 4,519,108 A \* 5/1985 Hodgson ..... 7/167  
 4,817,221 A \* 4/1989 Ryan ..... 7/148  
 D302,235 S 7/1989 Giordano  
 5,067,190 A \* 11/1991 Gagnon ..... 7/149  
 5,347,718 A 9/1994 Turner  
 5,771,588 A 6/1998 Petrich  
 D422,477 S \* 4/2000 Elishewitz ..... D8/99  
 D422,478 S \* 4/2000 Elishewitz ..... D8/99  
 6,220,128 B1 \* 4/2001 Hu ..... 81/489  
 D479,448 S \* 9/2003 Yang ..... D8/49  
 6,615,692 B2 \* 9/2003 Hu ..... 81/22  
 6,792,683 B1 9/2004 Nordstrom et al.  
 D519,813 S 5/2006 Hung  
 D535,539 S \* 1/2007 Chen ..... D8/80  
 D573,682 S \* 7/2008 Martinez ..... D22/118  
 D595,554 S 7/2009 Hardinge et al.  
 D610,646 S \* 2/2010 Harsey et al. .... D22/118  
 D636,051 S \* 4/2011 Freeman et al. .... D22/118  
 D636,052 S \* 4/2011 Freeman et al. .... D22/118

D636,053 S \* 4/2011 Freeman et al. .... D22/118  
 D638,904 S \* 5/2011 Freeman et al. .... D22/118  
 D705,035 S \* 5/2014 Horvath ..... D8/107  
 D709,982 S \* 7/2014 Freeman et al. .... D22/118  
 2005/0102845 A1 5/2005 Dallas et al.

OTHER PUBLICATIONS

U.S. Appl. No. 29/321,372, filed Jul. 15, 2008, Hardinge et al.  
 Ax International Pac-Ax, printed off website <http://aqdwr.org/knives/bob/tool/pac-ax.html> on Aug. 19, 2008, 1 page.  
 Back Paxe™, printed off website [www.gerbergear.com/product.php?model=5912](http://www.gerbergear.com/product.php?model=5912) on Aug. 19, 2008, 1 page.  
 Camp Axe, printed off website [www.gerbergear.com/product.php?model=5905](http://www.gerbergear.com/product.php?model=5905) on Aug. 19, 2008, 1 page.  
 Extra Large Axe, printed off website [www.gerbergear.com/product.php?model=2730](http://www.gerbergear.com/product.php?model=2730) on Aug. 19, 2008, 1 page.  
 Gator™ Axe, printed from website [www.gerbergear.com/product.php?model=9469](http://www.gerbergear.com/product.php?model=9469) on Aug. 19, 2008, 1 page.  
 Splitting Axe, printed from website [www.gerbergear.com/product.php?model=2763](http://www.gerbergear.com/product.php?model=2763) on Aug. 19, 2008, 1 page.  
 Sport Axe, printed off website [www.gerbergear.com/product.php?model=5907](http://www.gerbergear.com/product.php?model=5907) on Aug. 19, 2008, 1 page.

\* cited by examiner

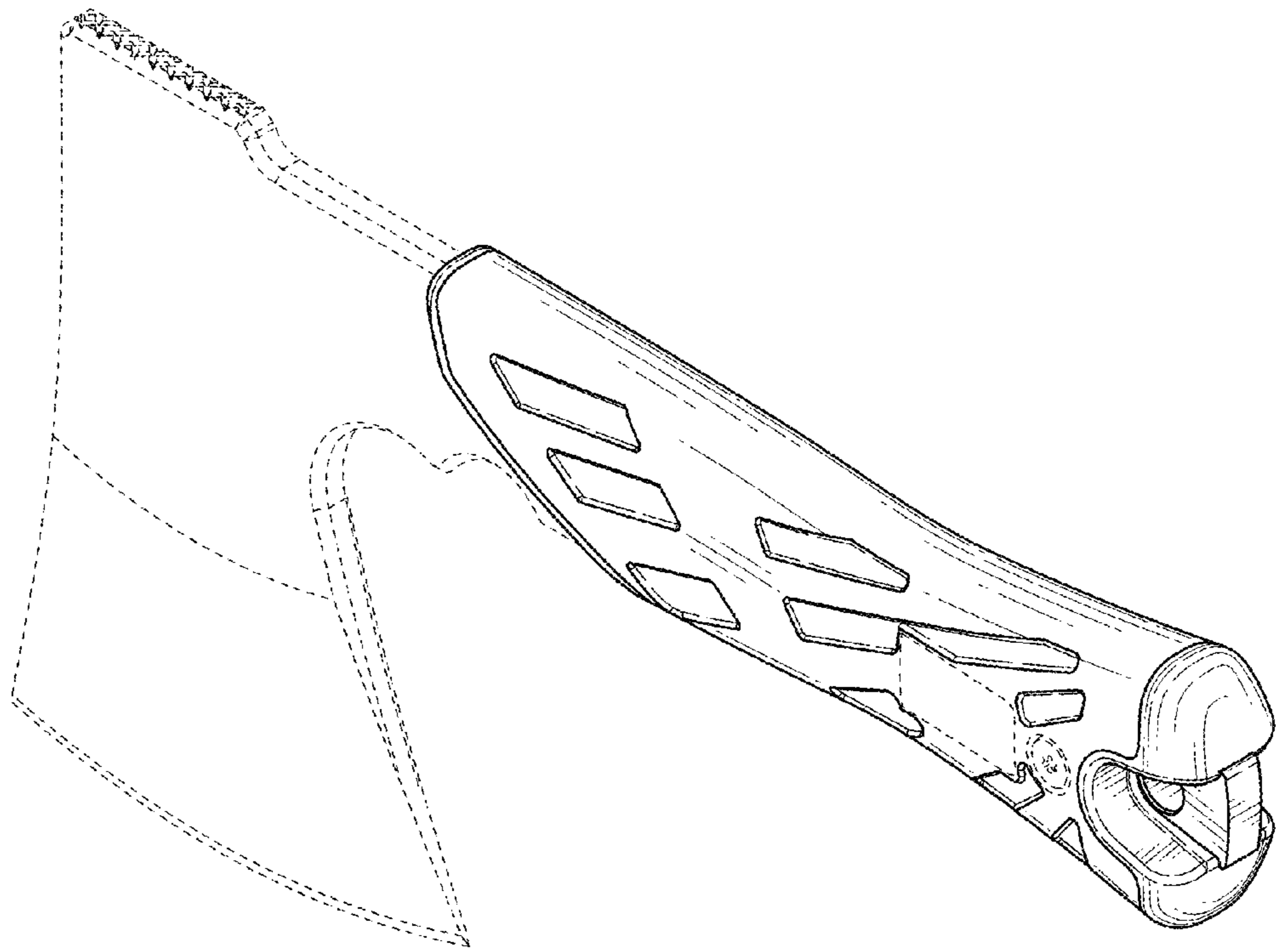

FIG. 1

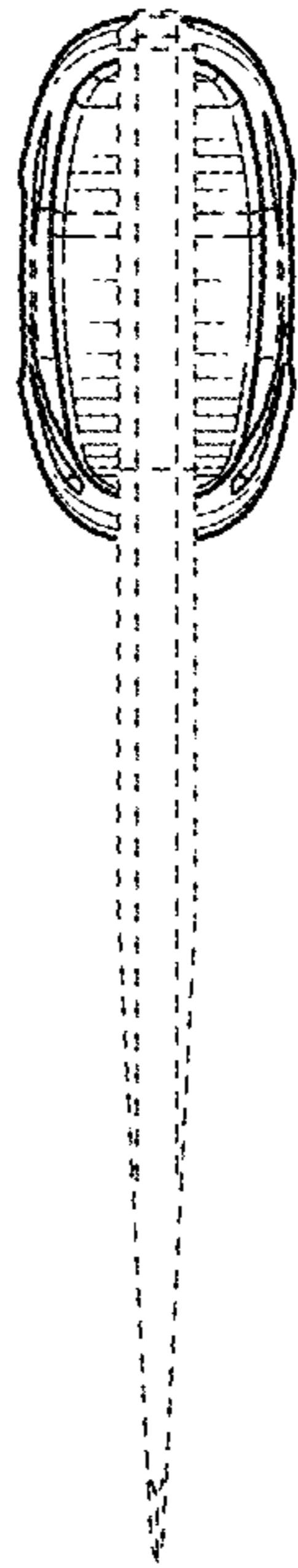

FIG. 2

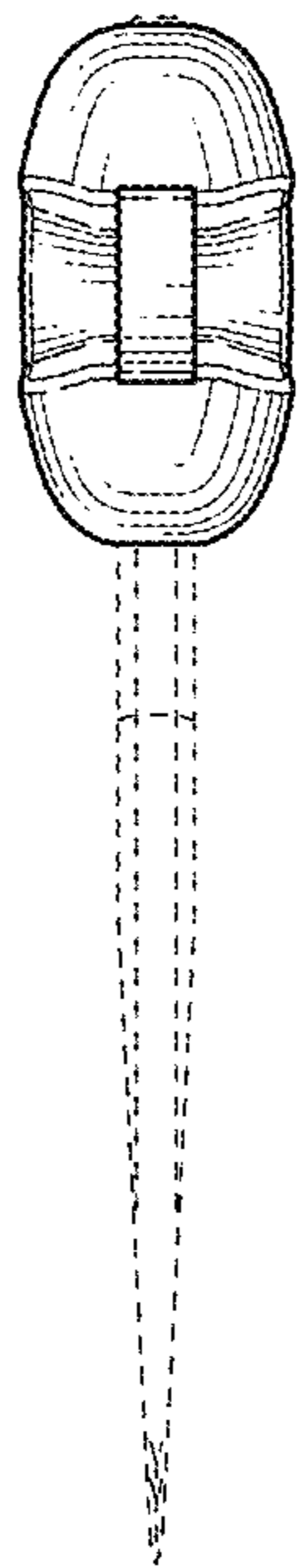

FIG. 3

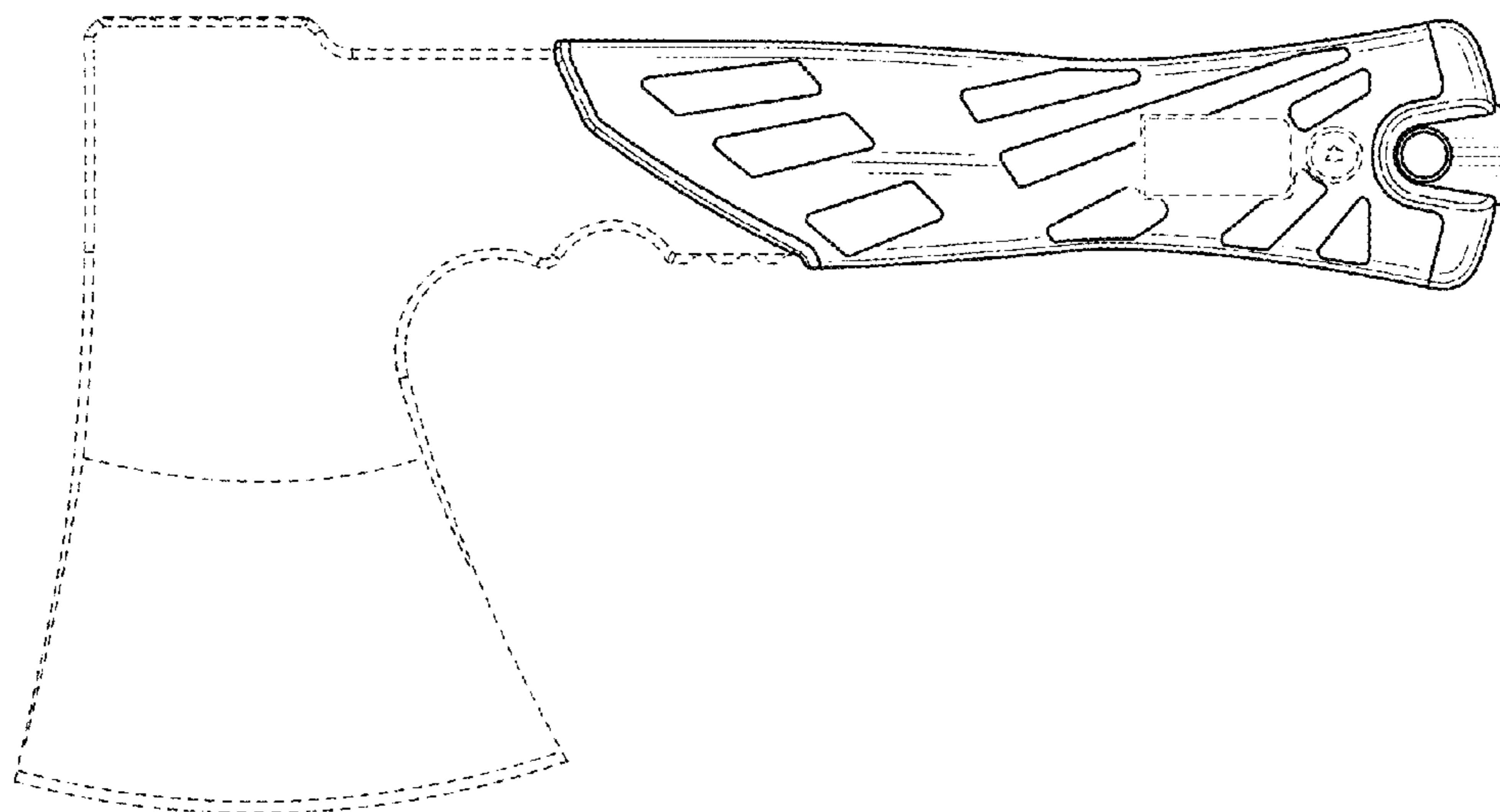

FIG. 4

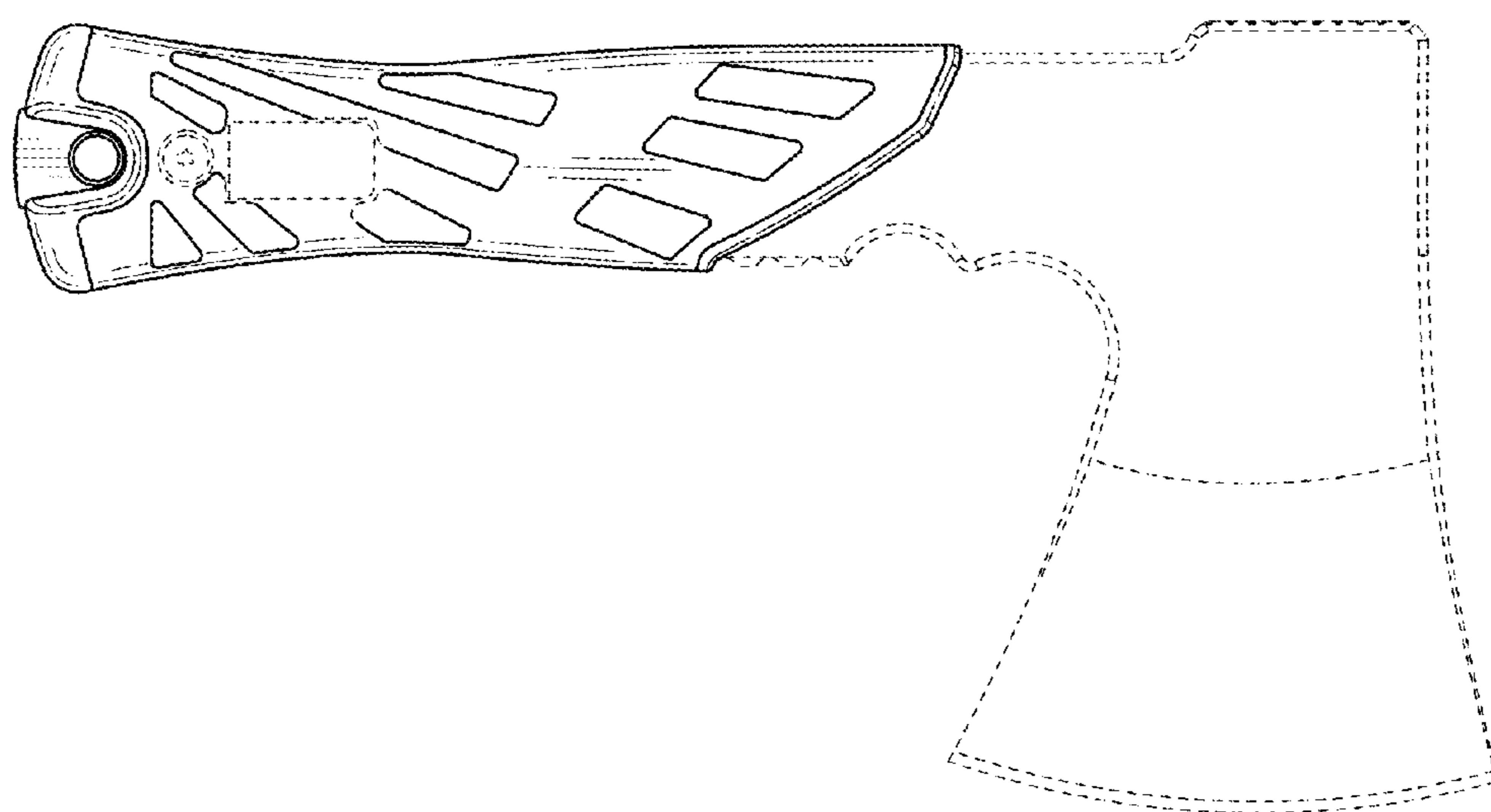

FIG. 5

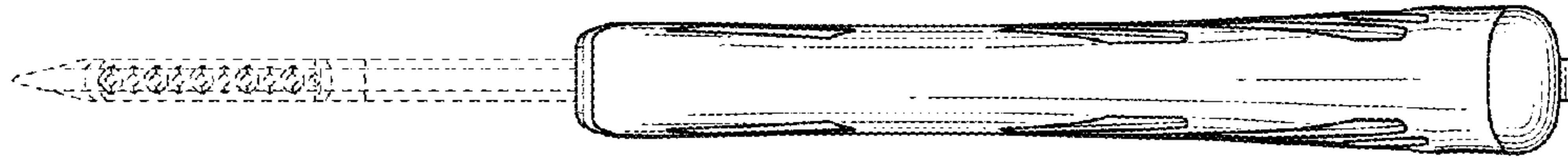

FIG. 6

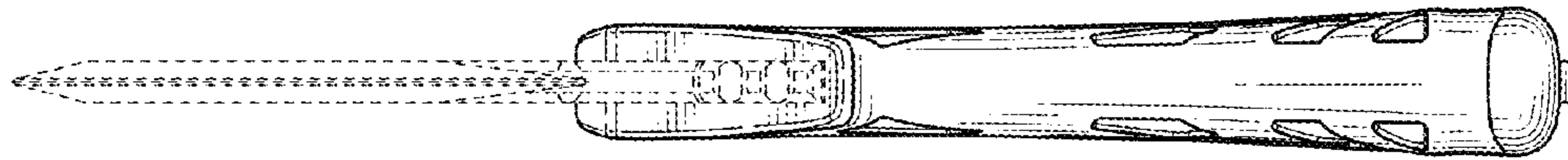

FIG. 7

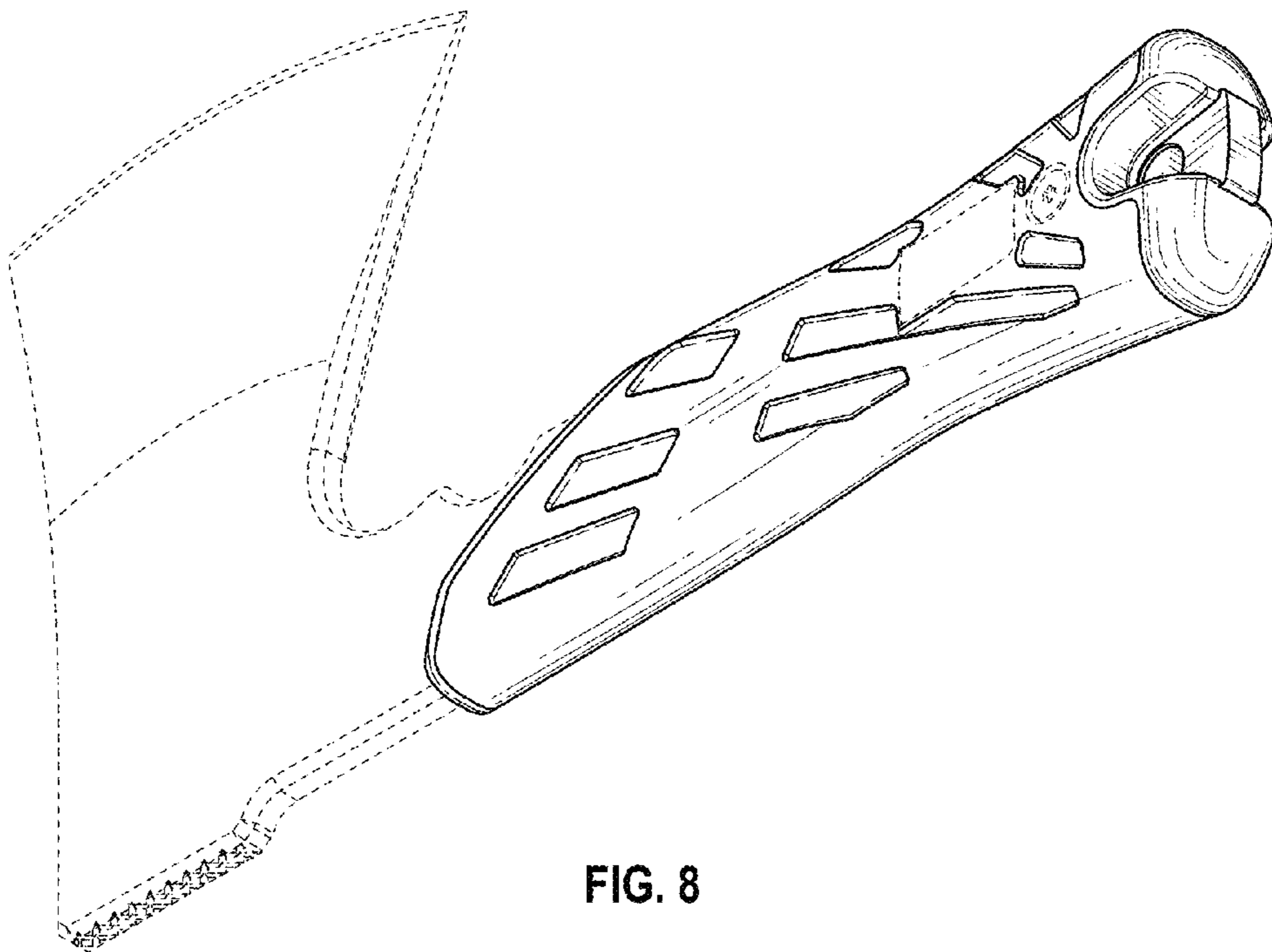

FIG. 8

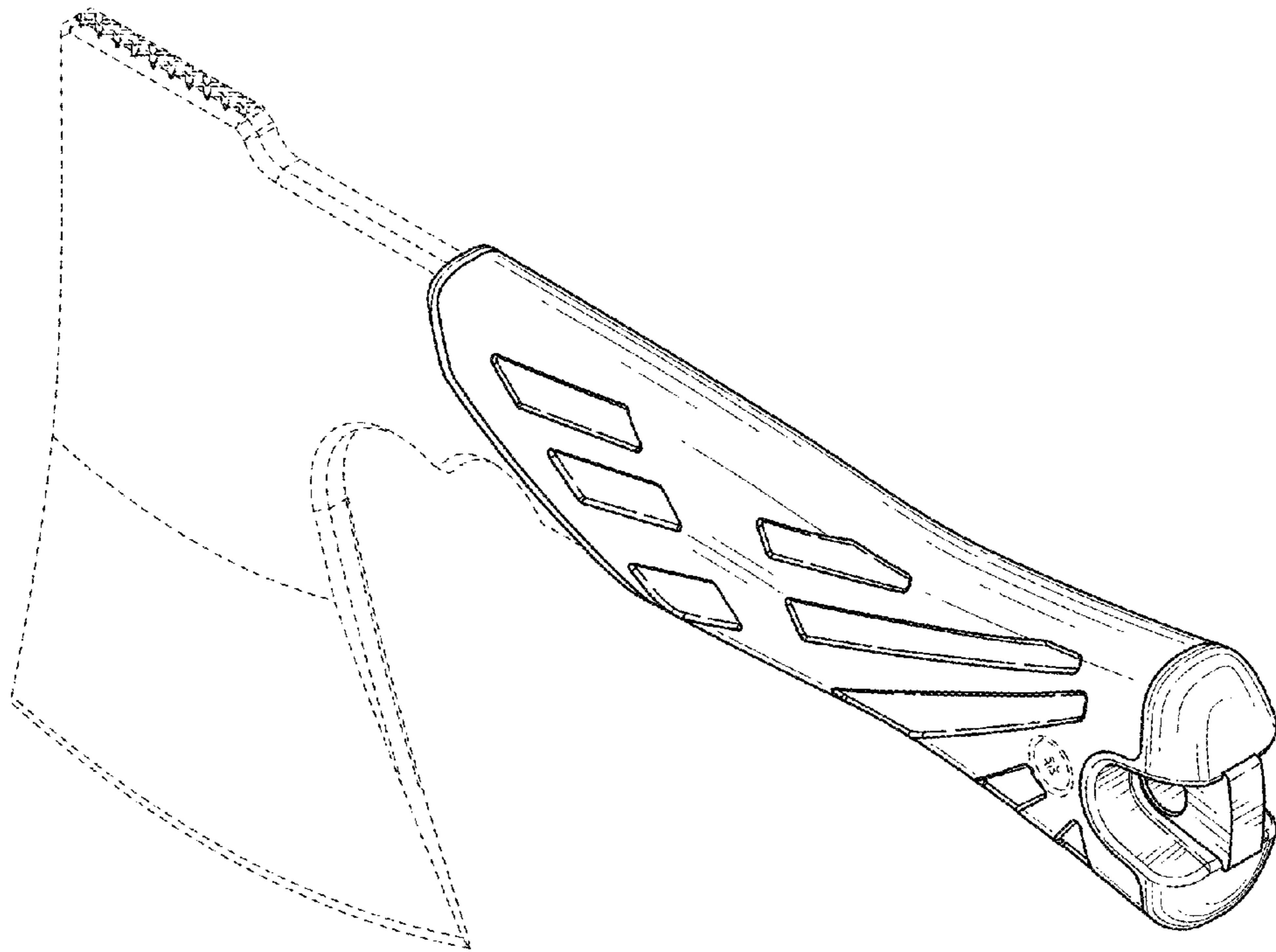

FIG. 9

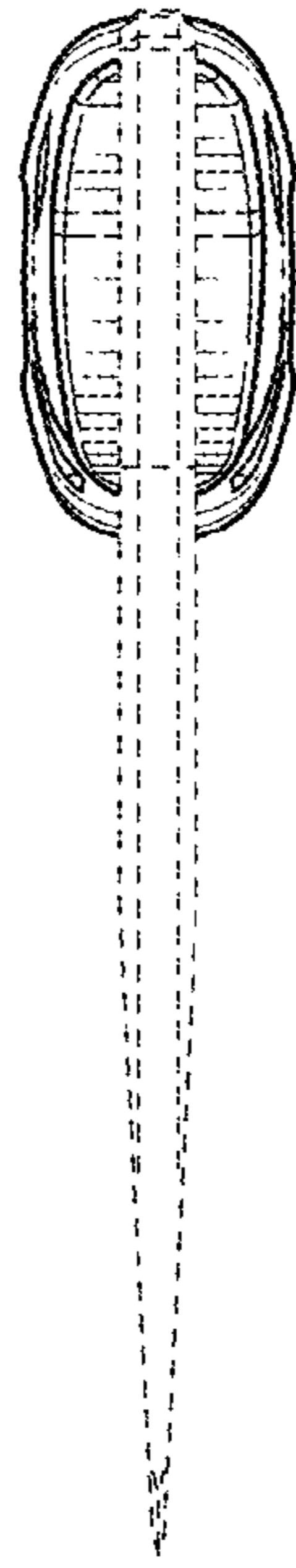

FIG. 10

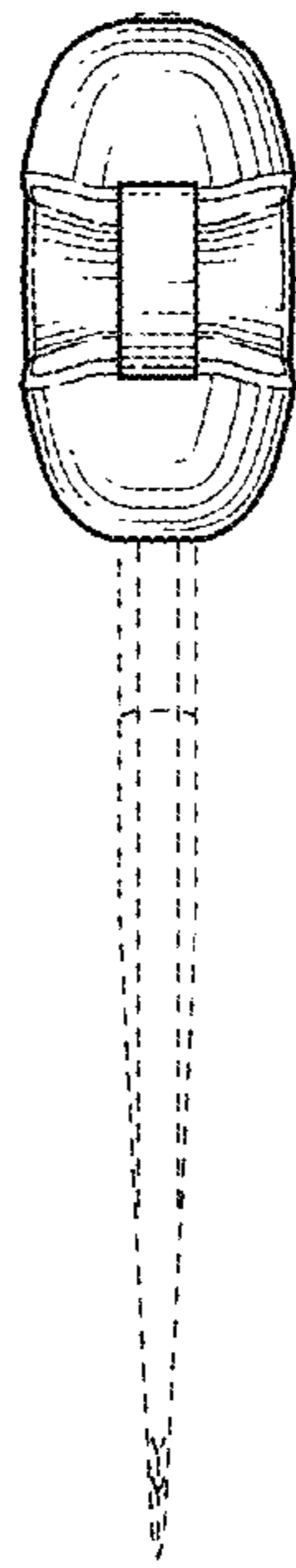

FIG. 11



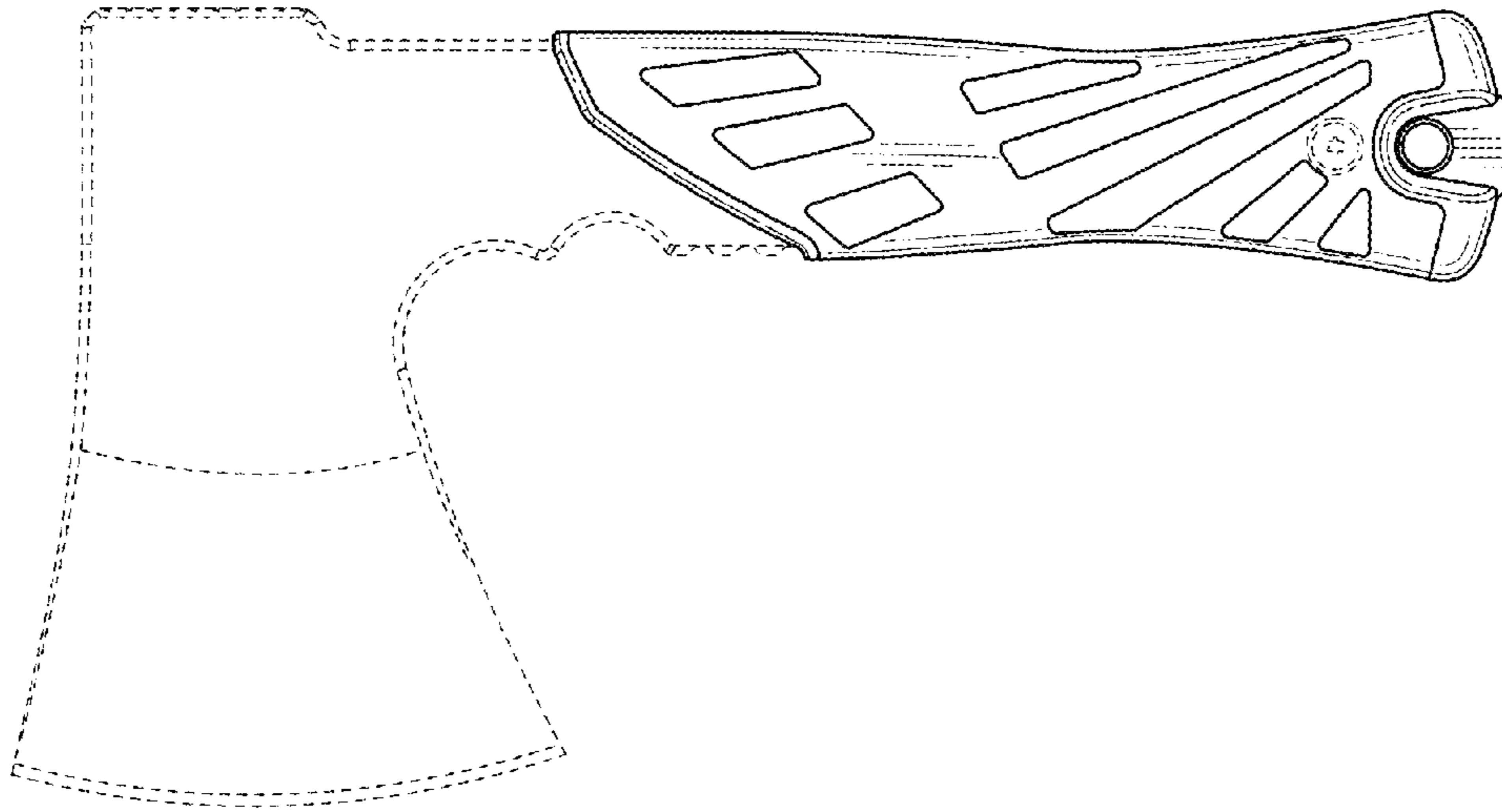

FIG. 12

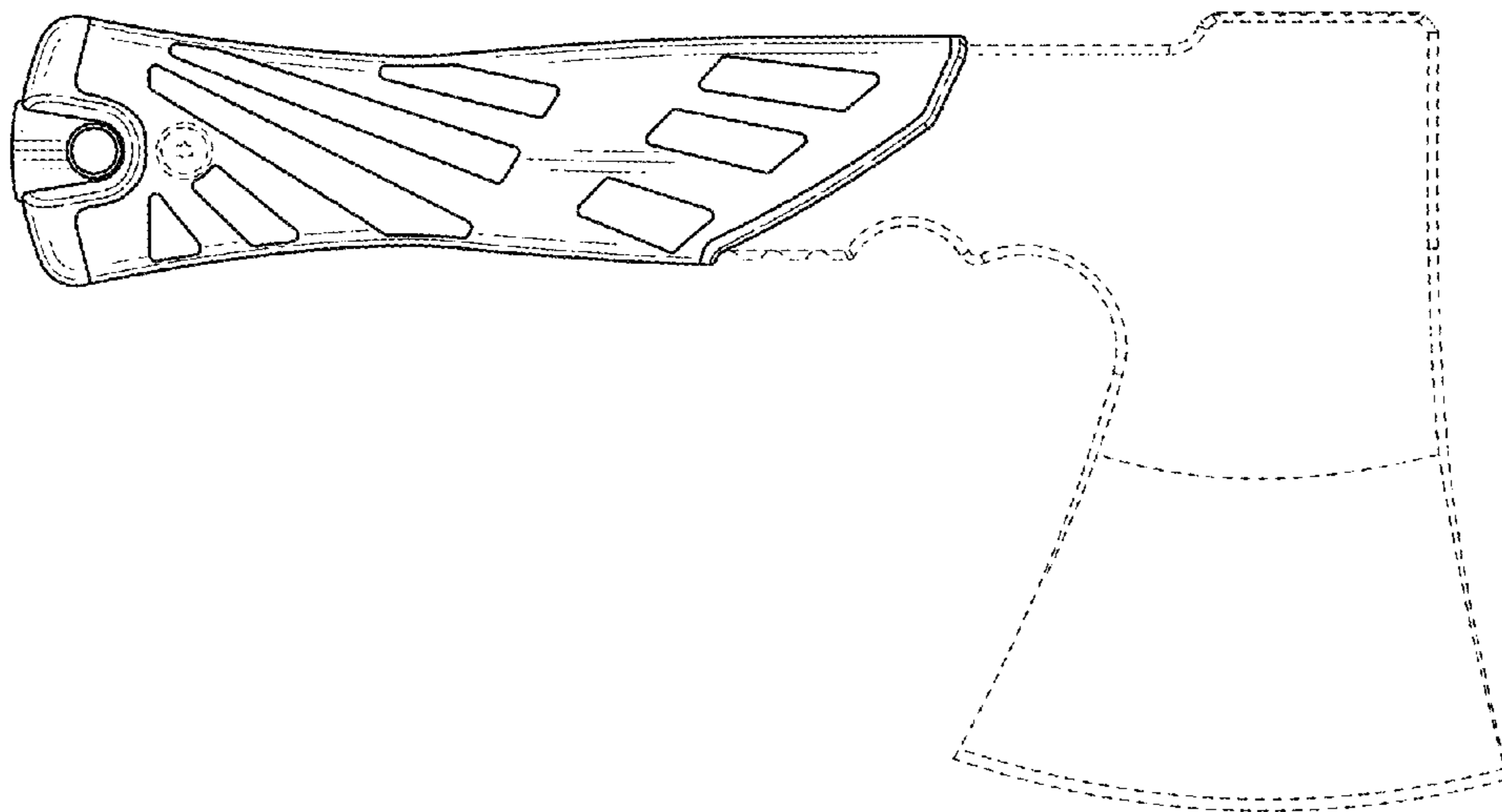

FIG. 13

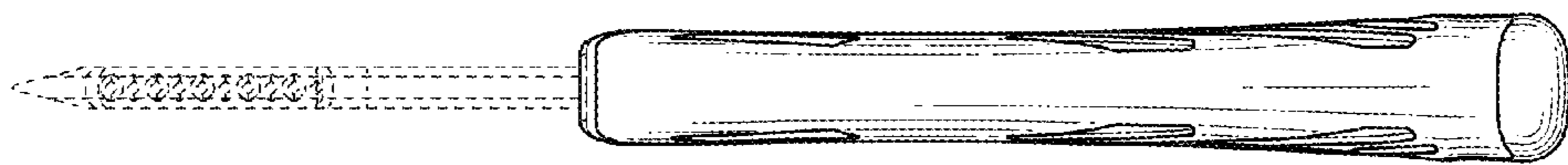

FIG. 14

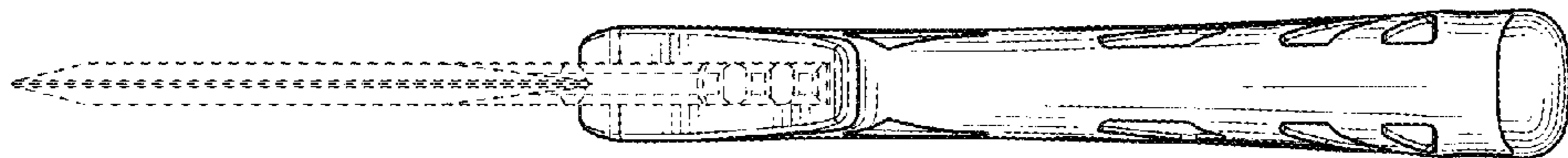

FIG. 15

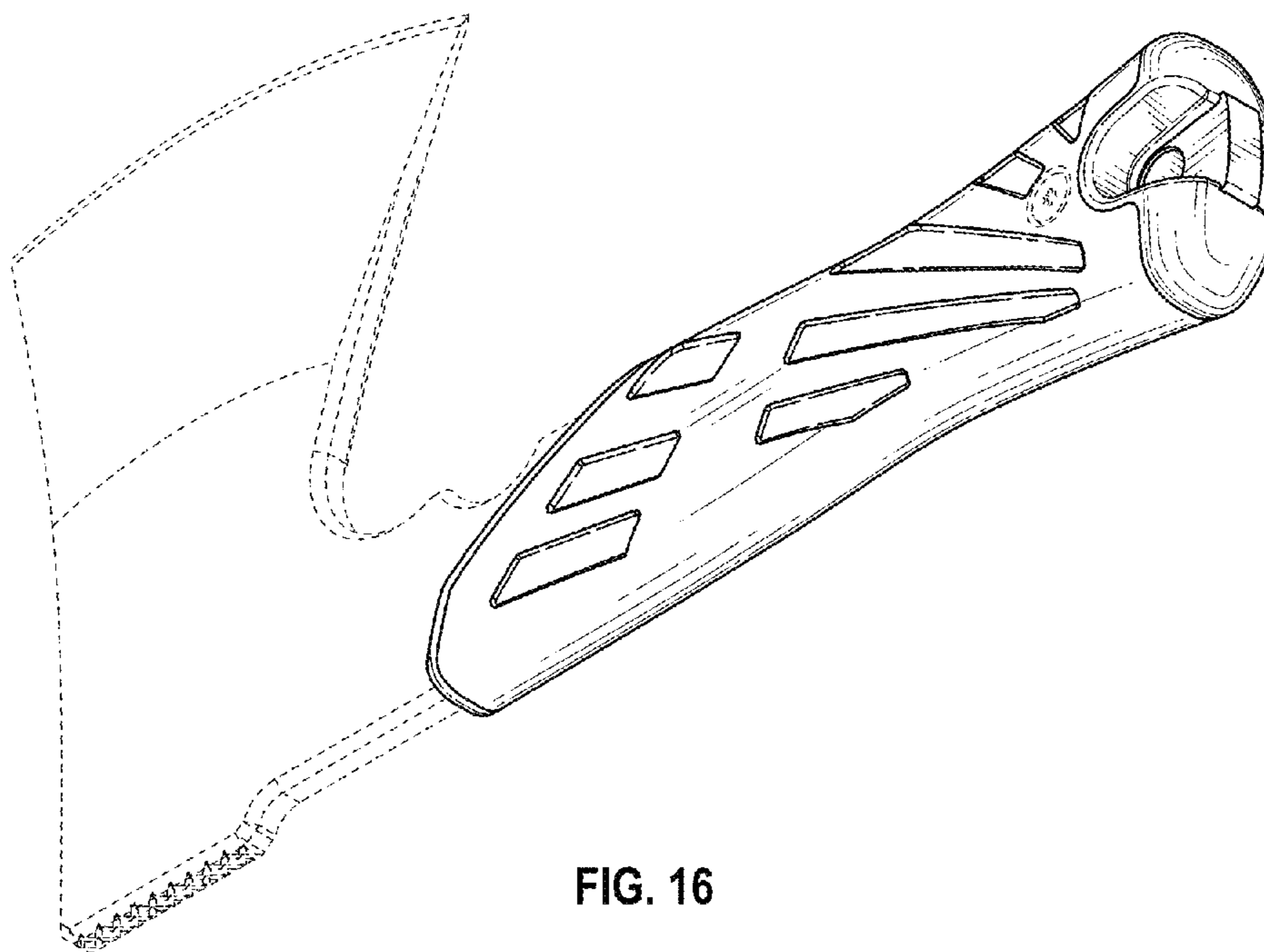

FIG. 16