

US00D735499S

(12) **United States Design Patent**
Stein

(10) **Patent No.:** **US D735,499 S**

(45) **Date of Patent:** **** Aug. 4, 2015**

(54) **CABINET WITH INTERCHANGEABLE FRONT PANEL**

(71) Applicant: **Shelley Stein**, Brooklyn, NY (US)

(72) Inventor: **Shelley Stein**, Brooklyn, NY (US)

(73) Assignee: **The 25th Hour LLC**, Brooklyn, NY (US)

(**) Term: **14 Years**

(21) Appl. No.: **29/476,816**

(22) Filed: **Dec. 17, 2013**

(51) **LOC (10) Cl.** **06-04**

(52) **U.S. Cl.**
USPC **D6/663**

(58) **Field of Classification Search**
USPC D6/657, 661, 663, 664, 666, 667, 671, D6/671.1, 671.2; D3/273
CPC A47F 3/00; A47F 3/005; A47F 3/06; A47B 17/04; A47B 47/03; A47B 67/00
See application file for complete search history.

(56) **References Cited**

U.S. PATENT DOCUMENTS

1,009,755 A * 11/1911 Lange A47F 3/06
1,253,356 A * 1/1918 Delaney A47B 47/03
3,554,623 A * 1/1971 Suckle et al. A47B 47/03
D255,518 S * 6/1980 Logsdon D6/663
4,448,463 A * 5/1984 Amos A47B 67/00

D336,177 S * 6/1993 Kulaga D6/663
6,869,154 B2 * 3/2005 Vandebussche A47F 3/00
D504,771 S * 5/2005 Boyd et al. D3/273
D592,889 S * 5/2009 Carter et al. D6/661
D696,526 S * 12/2013 Christensen D6/661

* cited by examiner

Primary Examiner — Mimoso De

(74) *Attorney, Agent, or Firm* — King & Spalding LLP

(57) **CLAIM**

The ornamental design for a cabinet with an interchangeable front panel, as shown and described.

DESCRIPTION

FIG. 1 is a top plan view of a cabinet without a front panel, showing my new design;
FIG. 2 is a right side elevational view thereof;
FIG. 3 is a front elevational view thereof;
FIG. 4 is a rear elevational view thereof;
FIG. 5 is a front perspective view thereof;
FIG. 6 is a top cross-sectional view thereof; and
FIG. 7 is a side cross-sectional view thereof.
FIG. 8 is a top plan view of an alternate embodiment of the cabinet with a front panel, showing my new design;
FIG. 9 is a right side elevation view thereof;
FIG. 10 is a front elevational view thereof;
FIG. 11 is a rear elevational view thereof;
FIG. 12 is a front perspective view thereof;
FIG. 13 is a top cross-sectional view thereof; and,
FIG. 14 is a side cross-sectional view thereof.

1 Claim, 8 Drawing Sheets

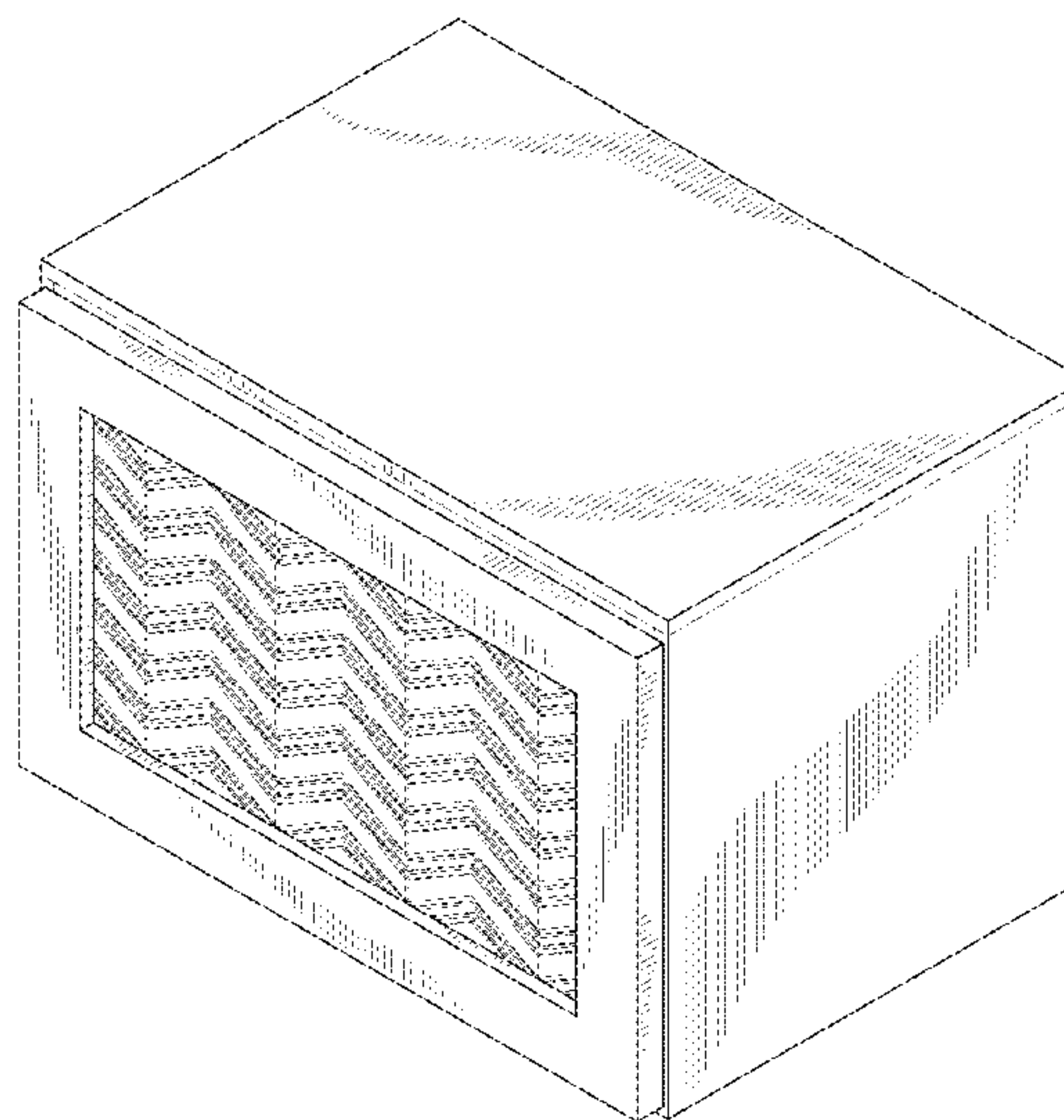
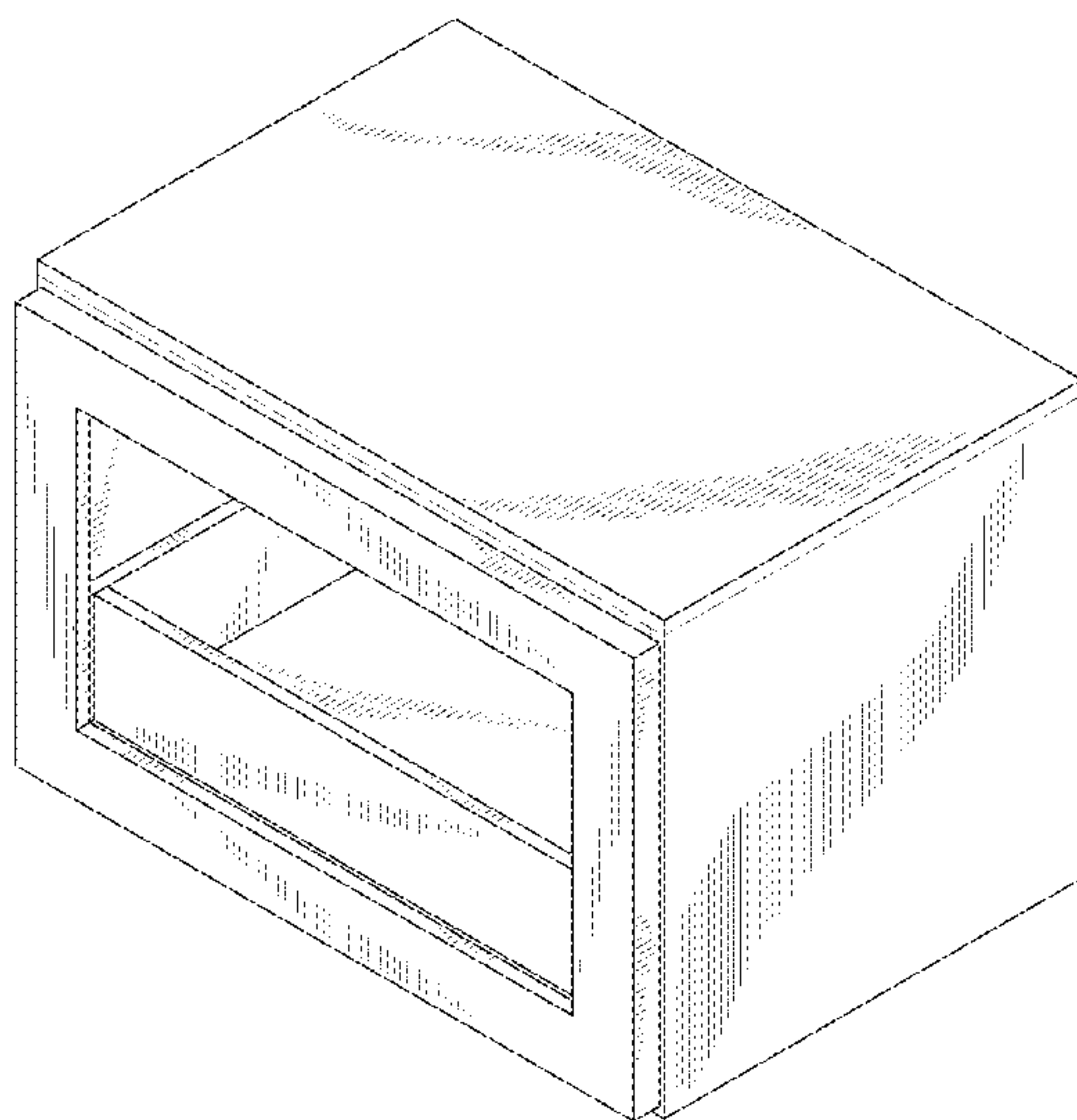

FIG. 1

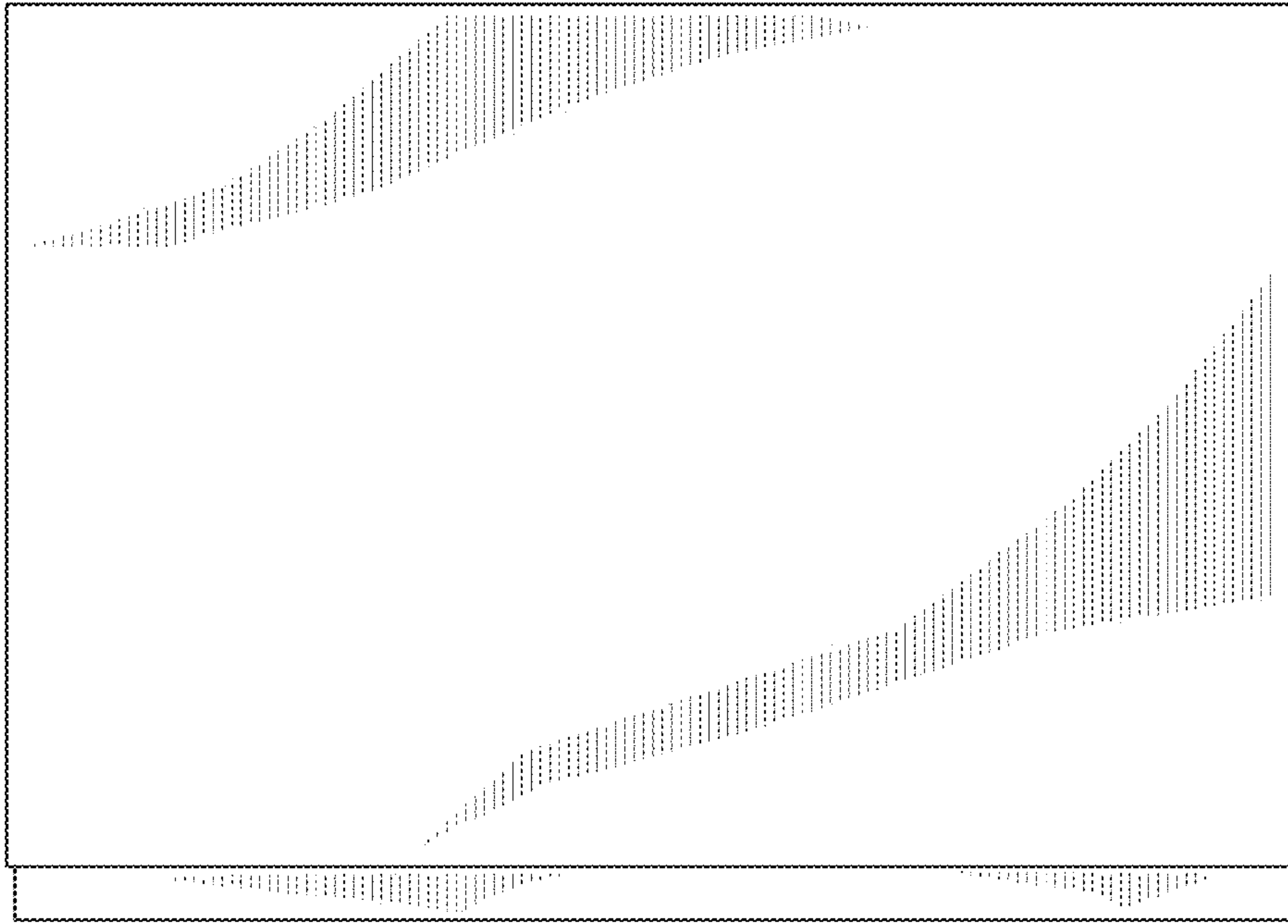

FIG. 2

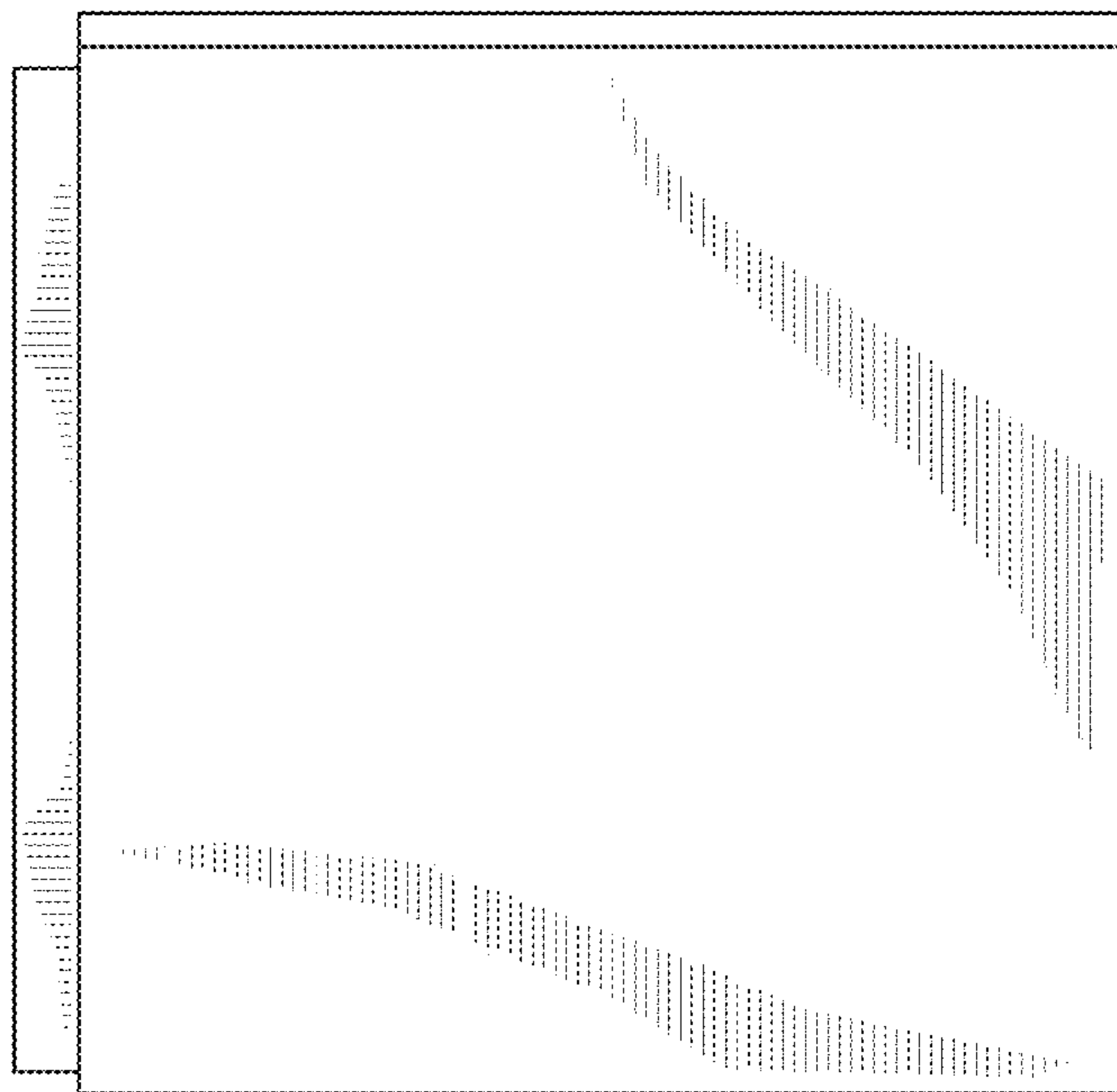

FIG. 3

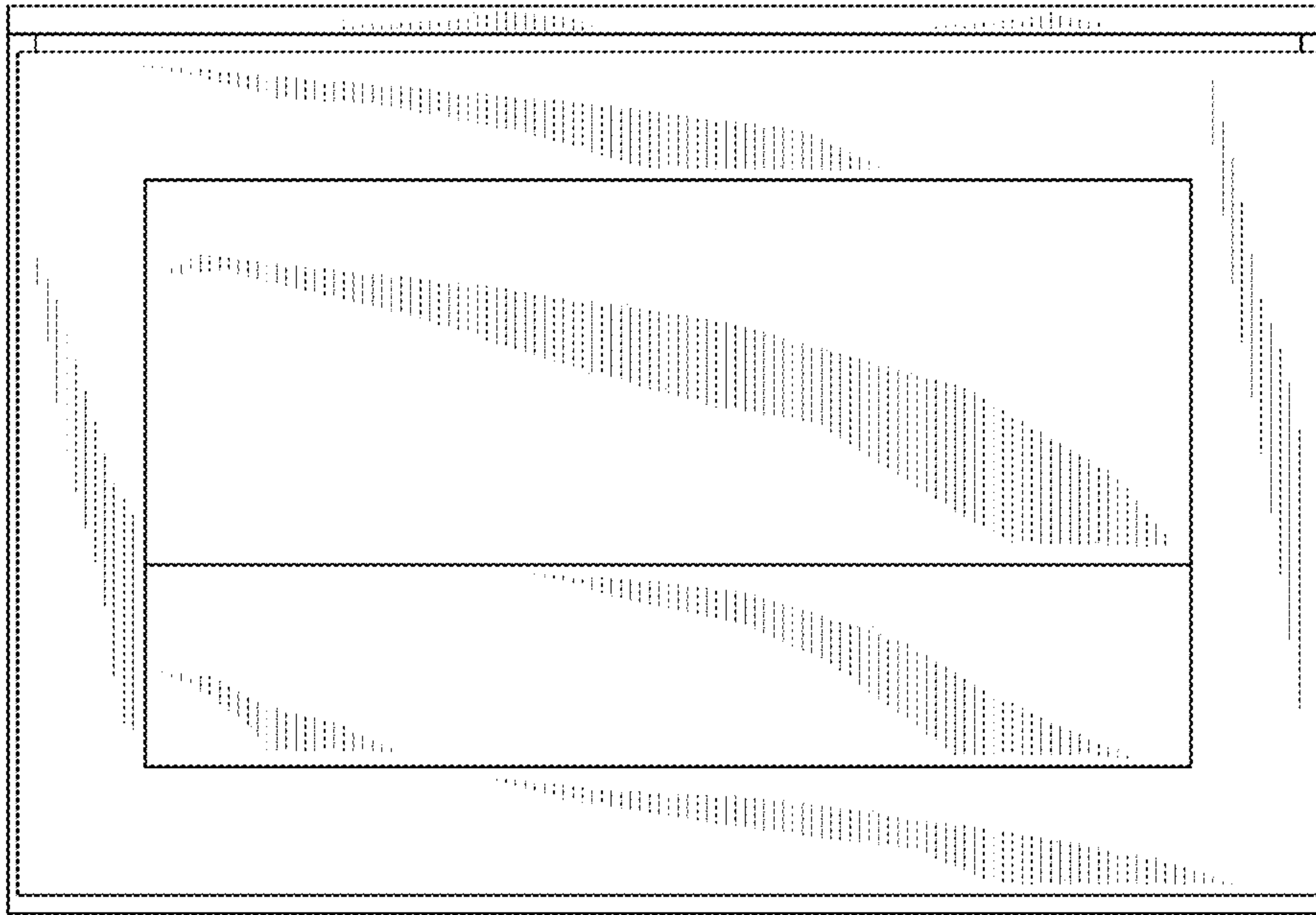

FIG. 4

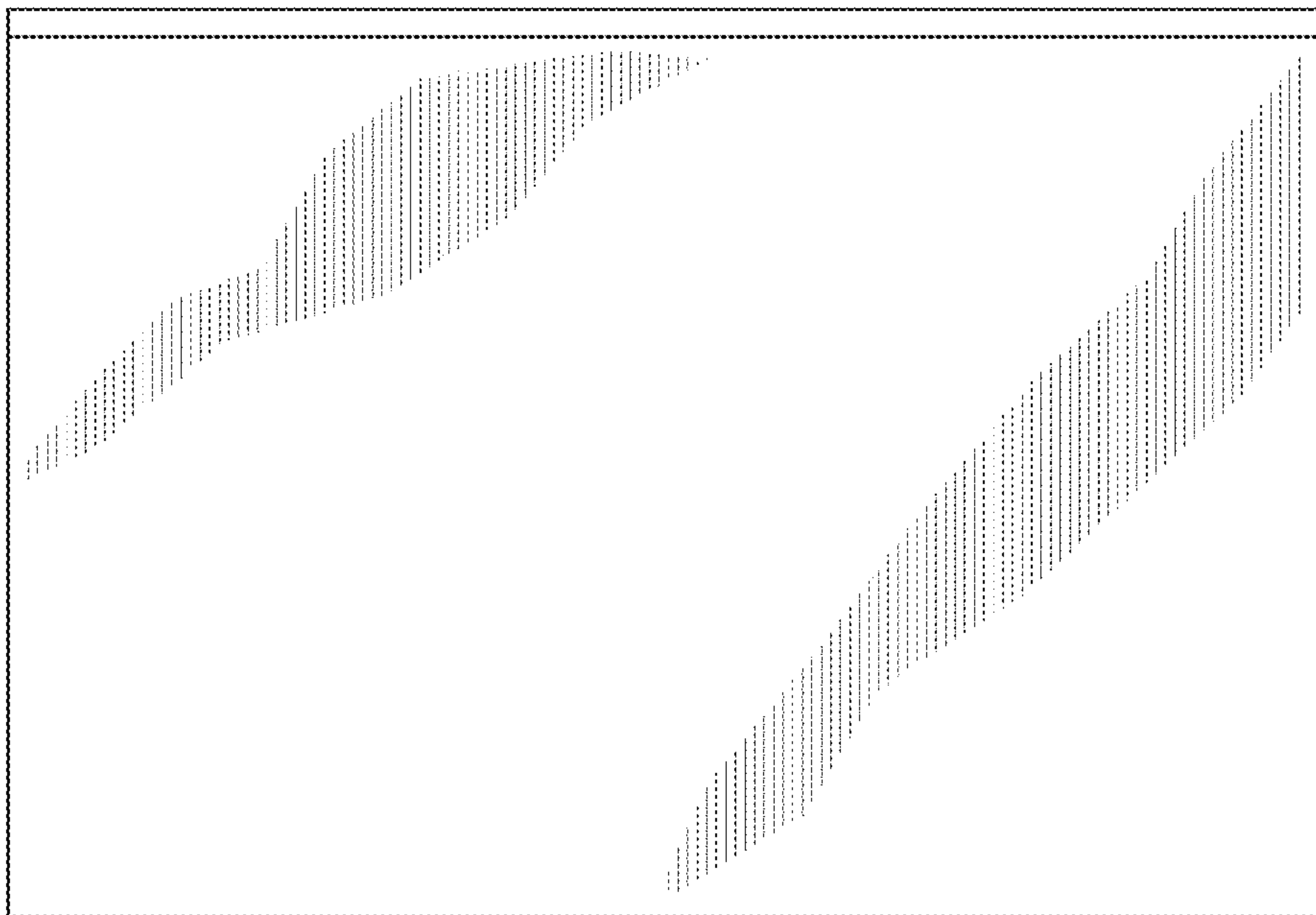

FIG. 5

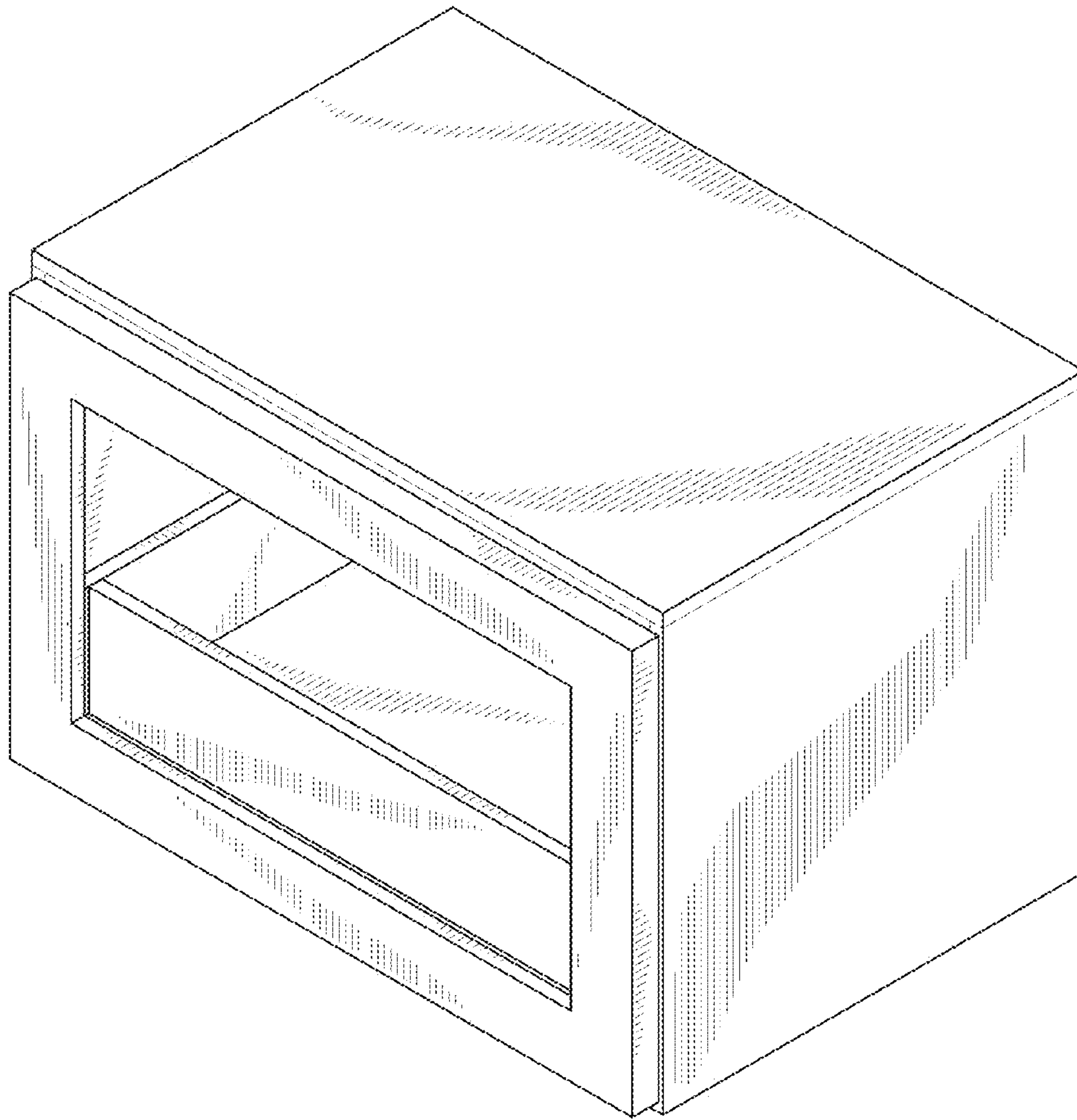

FIG. 6

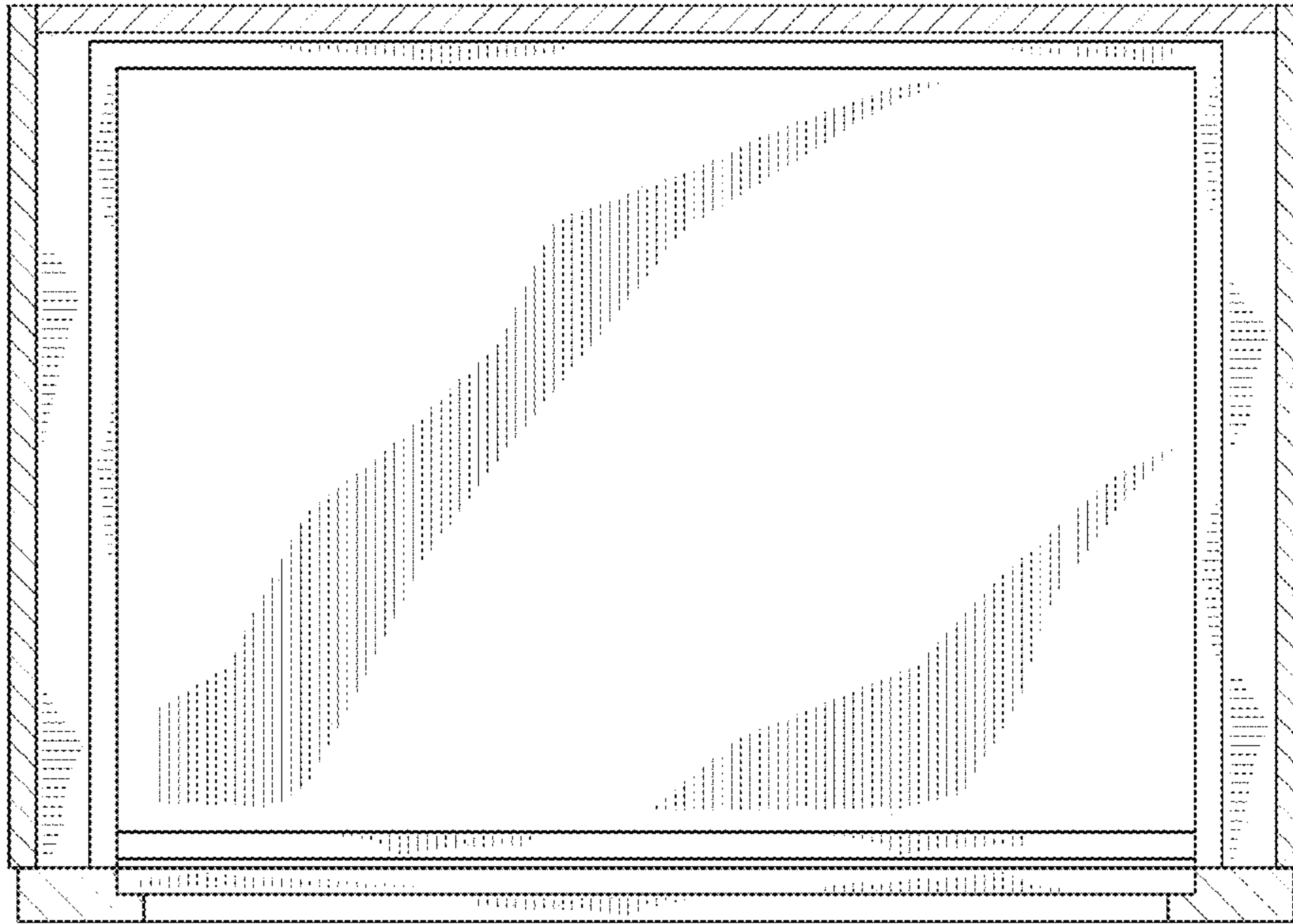

FIG. 7

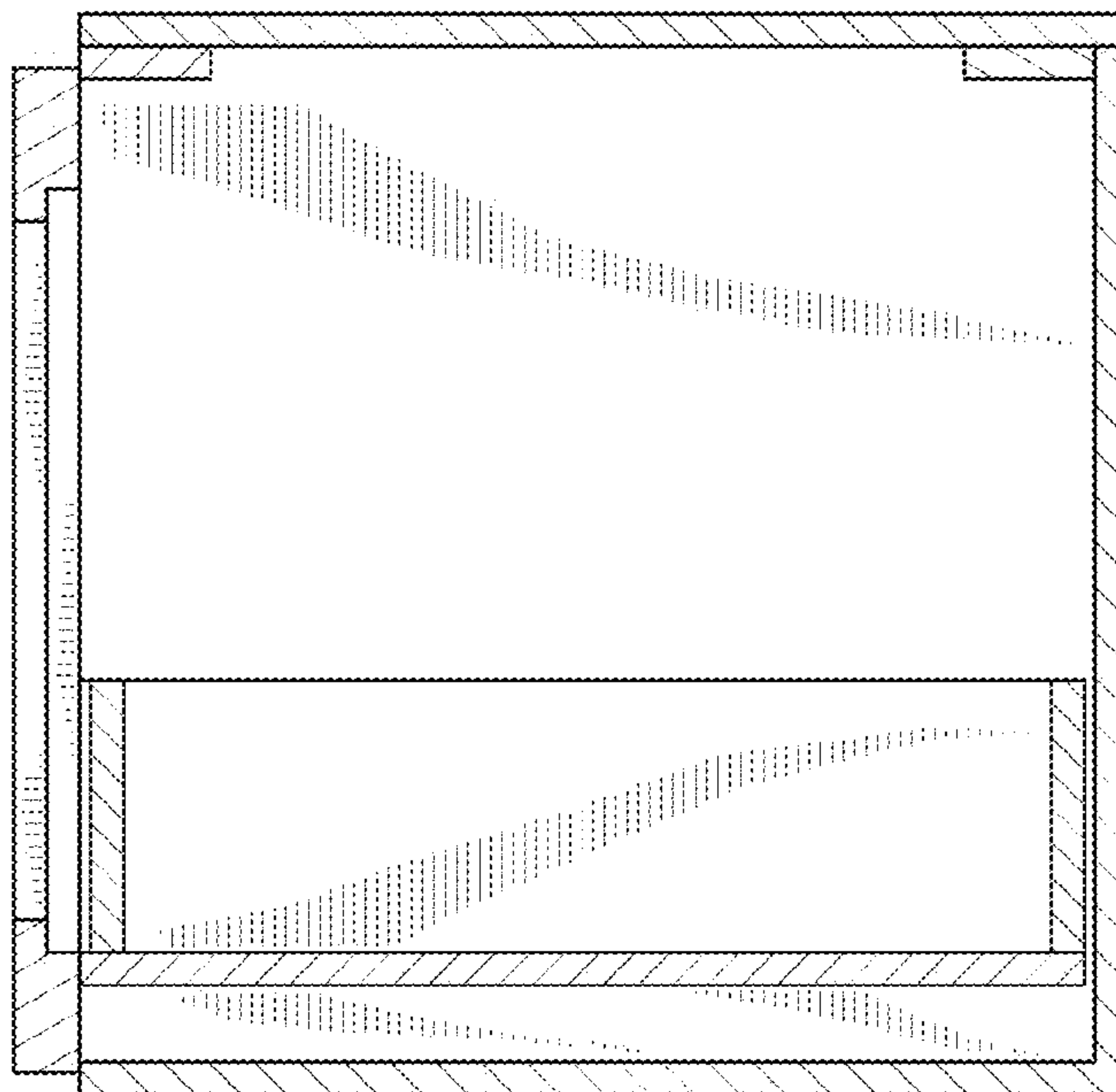

FIG. 8

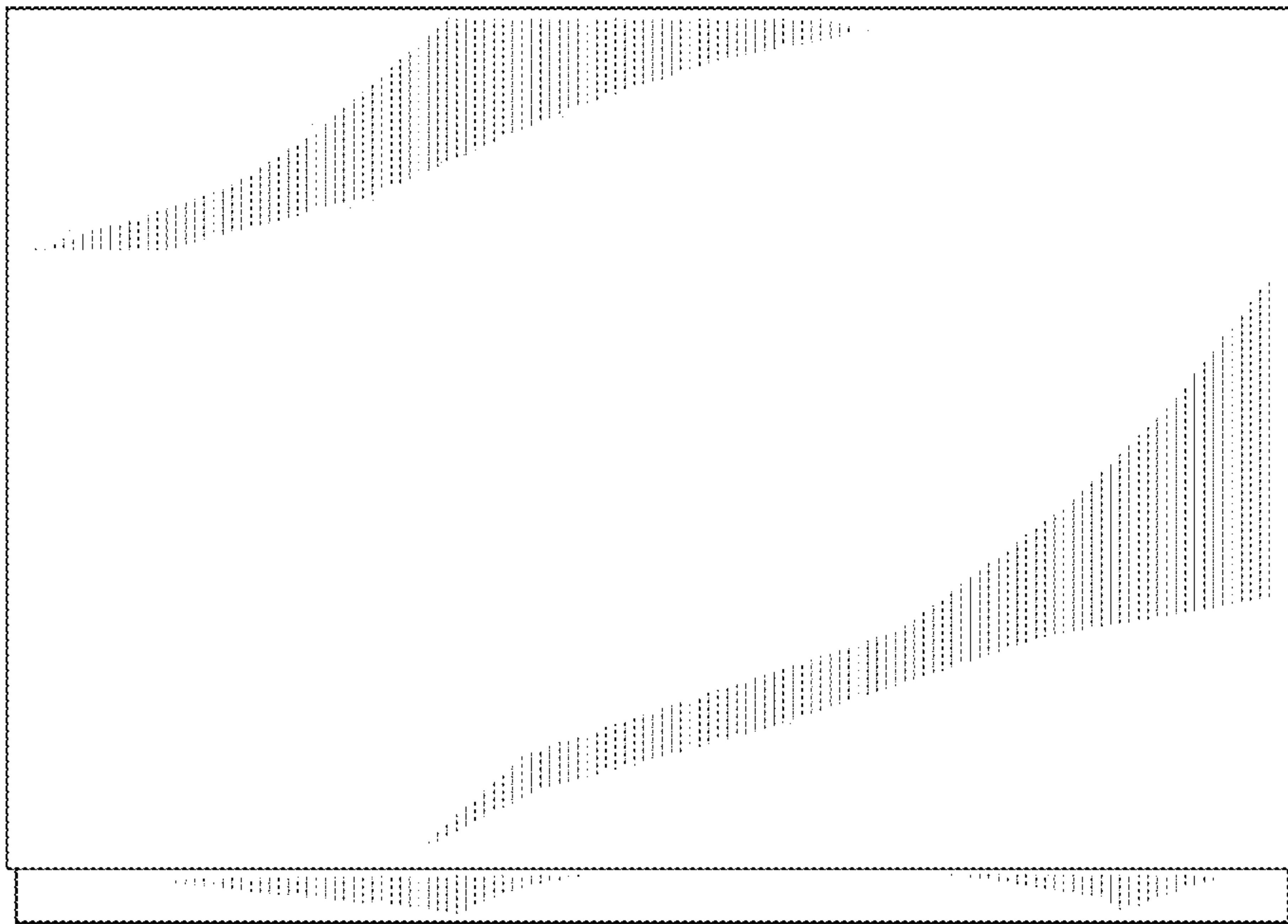

FIG. 9

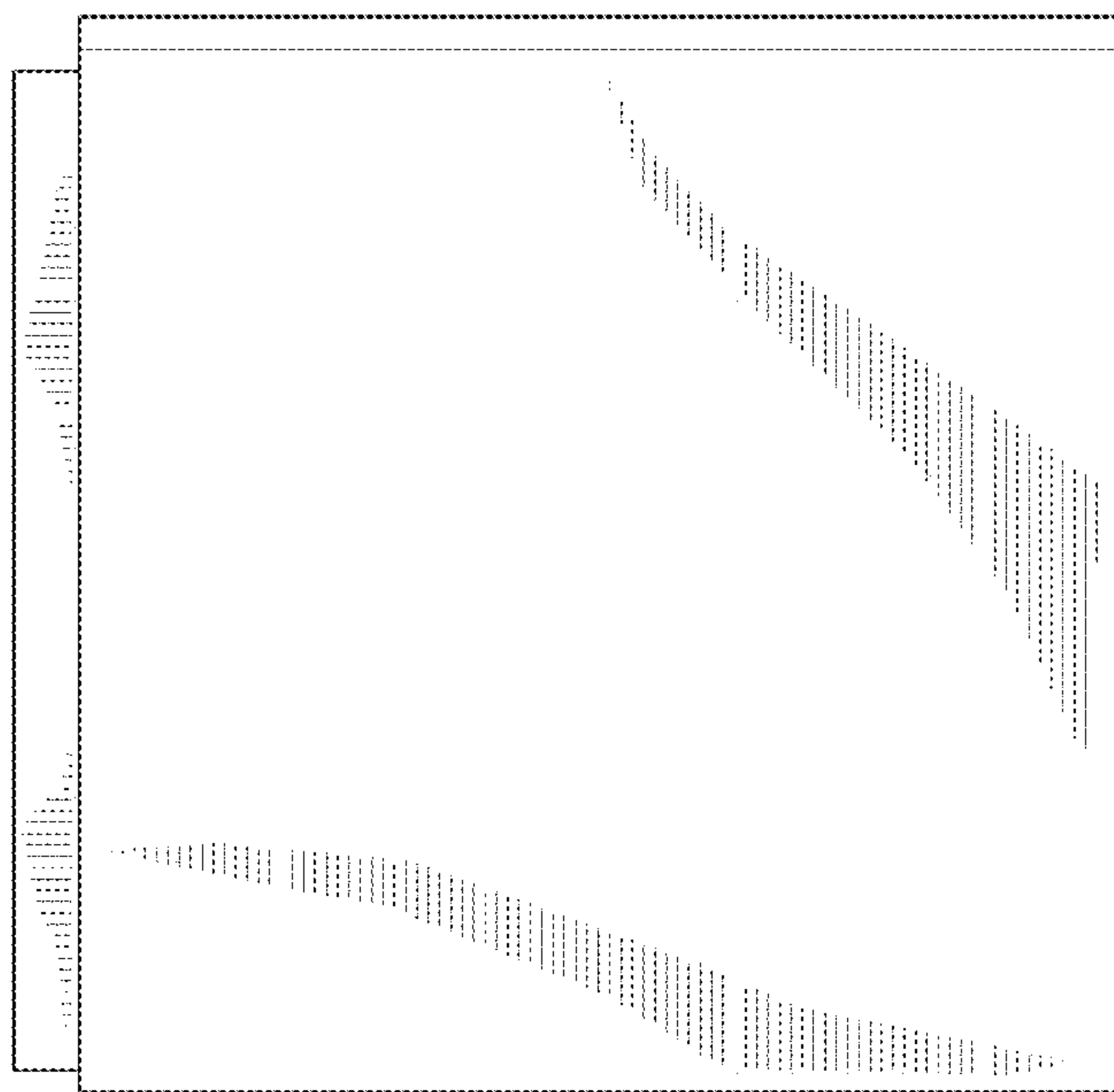

FIG. 10

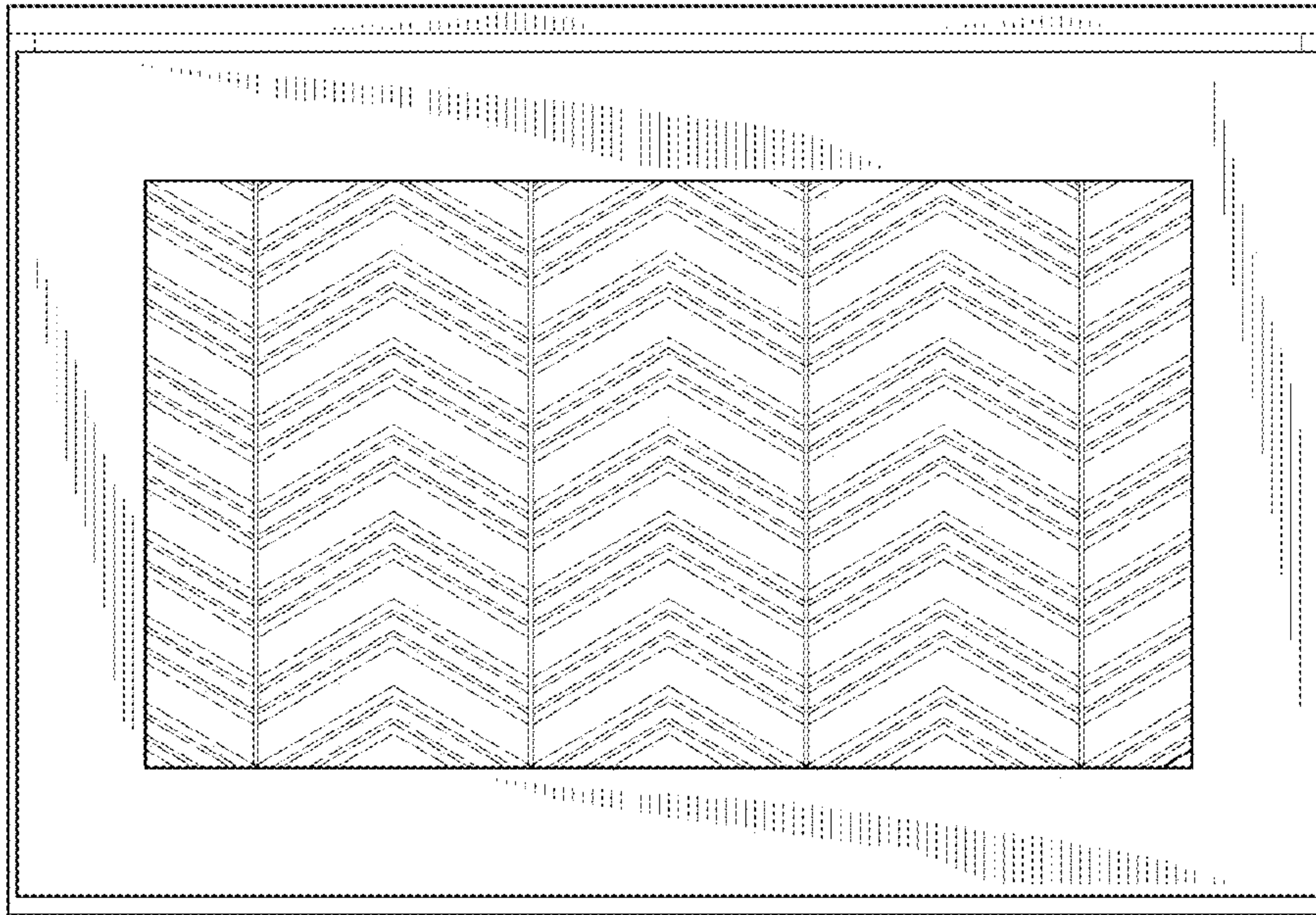

FIG. 11

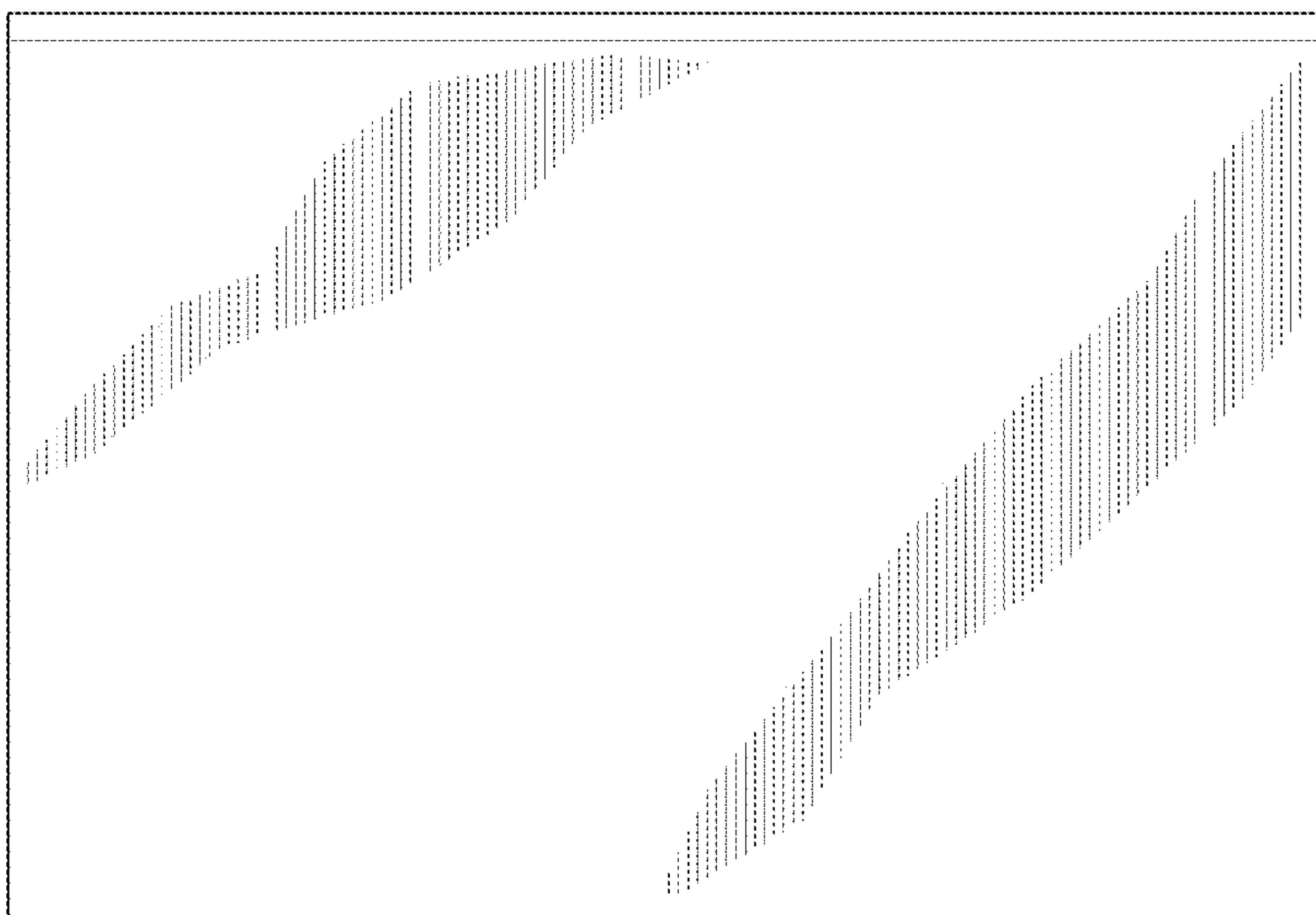

FIG. 12

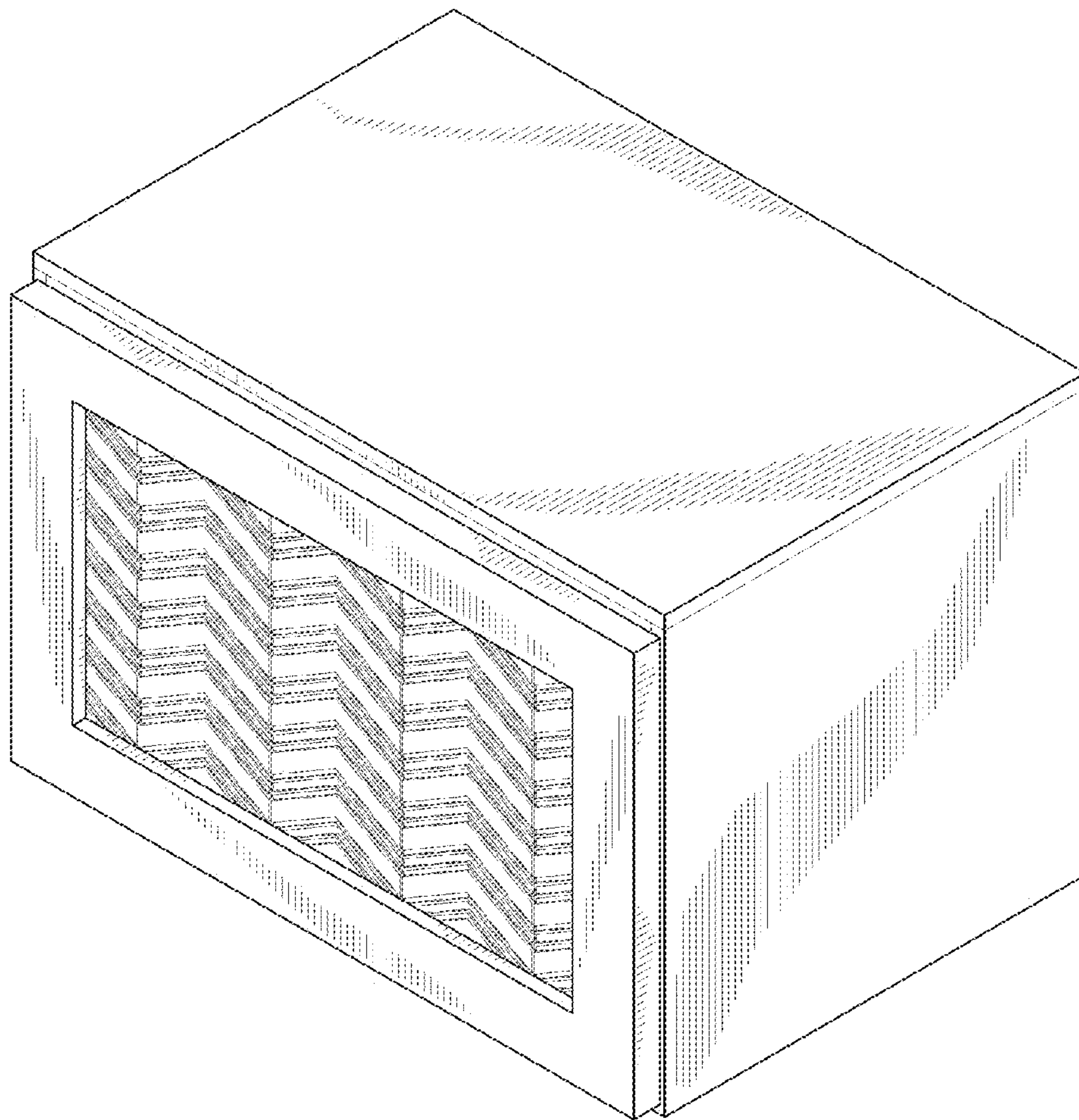

FIG. 13

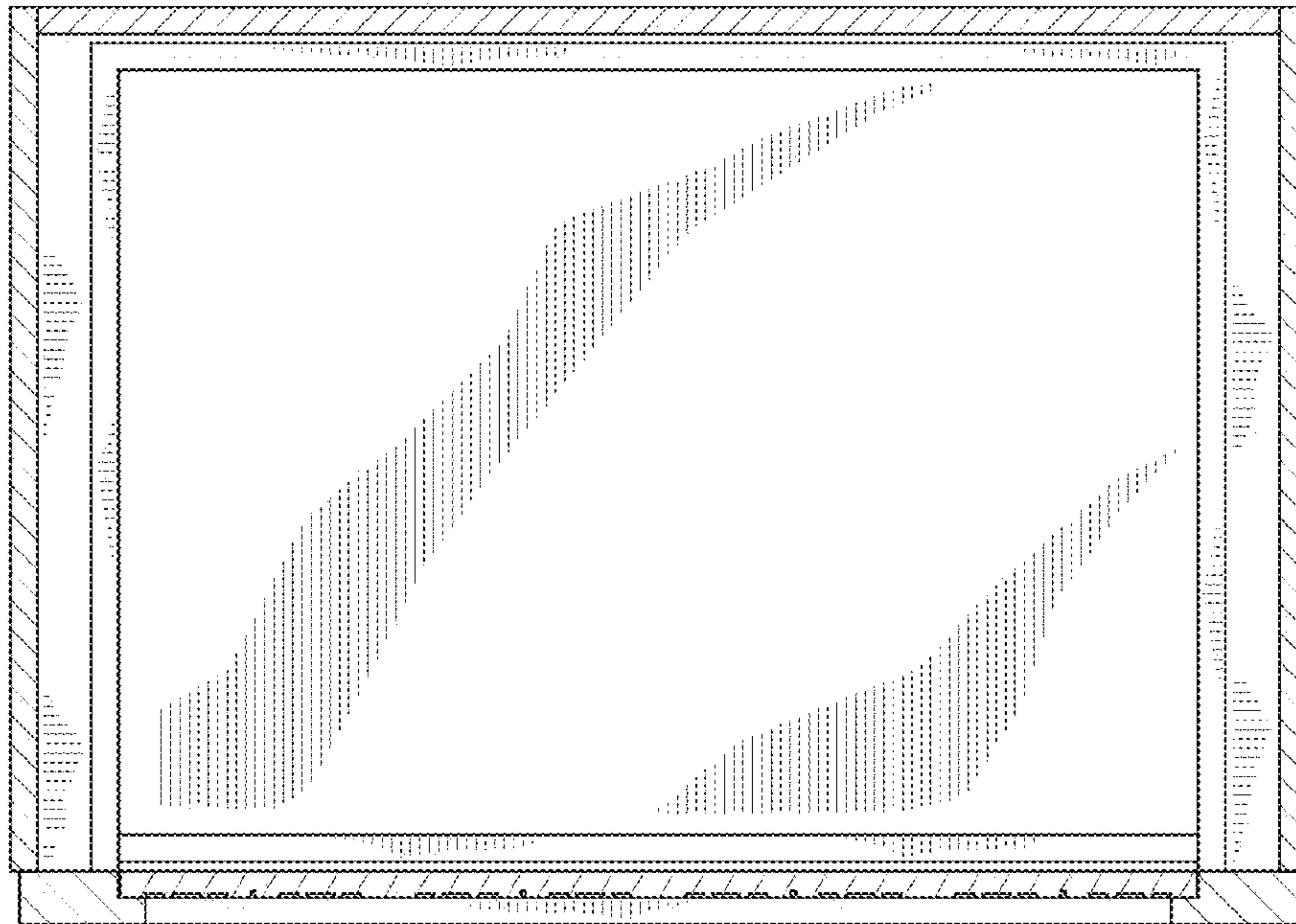

FIG. 14

