



US00D735498S

(12) **United States Design Patent**  
**Dworman**

(10) **Patent No.:** **US D735,498 S**  
(45) **Date of Patent:** **\*\* Aug. 4, 2015**

(54) **DESK WITH HIDDEN COMPARTMENTS**

**DESCRIPTION**

- (71) Applicant: **Matthew B. Dworman**, E. Kingston, NH (US)
- (72) Inventor: **Matthew B. Dworman**, E. Kingston, NH (US)
- (\*\*) Term: **14 Years**
- (21) Appl. No.: **29/469,897**
- (22) Filed: **Oct. 15, 2013**
- (51) **LOC (10) Cl.** ..... **06-03**
- (52) **U.S. Cl.**  
USPC ..... **D6/651**
- (58) **Field of Classification Search**  
USPC ..... D6/641, 656, 651, 652  
CPC ..... A47B 17/04; A47B 88/22; A47B 81/00;  
A47B 2200/0027; A47B 2200/0029; A47B  
17/00; A47B 17/003; A47B 21/00; A47B  
2097/006; A47B 21/02  
See application file for complete search history.

This invention relates to the following applications, filed on the even date herewith, and herein incorporated by reference: U.S. patent application Ser. No. 29/469,902, entitled Table with Hidden Compartments, by Matthew B. Dworman; U.S. patent application Ser. No. 29/469,901, entitled Double Shelving System with Hidden Compartments, by Matthew B. Dworman; U.S. patent application Ser. No. 29/469,900, entitled Cabinets with Hidden Compartment, by Matthew B. Dworman; and U.S. patent application Ser. No. 29/469,898, entitled Shelving System with Hidden Compartments, by Matthew B. Dworman.

FIG. 1 is a perspective view of a desk with hidden compartments, showing my new design, with the drawers and compartments shown in a closed position; FIG. 2 is a front perspective view thereof; FIG. 3 is a side perspective view of the desk of FIG. 1 as viewed from its left side, with the right side being a mirror image thereof; FIG. 4 is a rear perspective view thereof; FIG. 5 is a top perspective view thereof; FIG. 6 is a bottom perspective view thereof; FIG. 7 is a perspective view of the desk of FIG. 1 with its drawers shown in an open condition and its compartments shown in a closed condition; FIG. 8 is a front perspective view of the desk of FIG. 7; FIG. 9 is a side perspective view of the desk of FIG. 7 from its right side, with its left side being a mirror image thereof; FIG. 10 is a top perspective view of the desk of FIG. 7; FIG. 11 is a bottom perspective view of the desk of FIG. 7; FIG. 12 is a perspective view of the desk of FIG. 1 with its drawers shown in an open condition and its compartments shown in an open condition; FIG. 13 is a front perspective view of the desk of FIG. 12; FIG. 14 is a side perspective view of the desk of FIG. 12 from its right side, with its left side being a mirror image thereof; FIG. 15 is a top perspective view of the desk of FIG. 12; and, FIG. 16 is a bottom perspective view of the desk of FIG. 12. The hardware for the desk is shown in broken lines for illustrative purposes only and forms no part of the claimed design.

(56) **References Cited**

**U.S. PATENT DOCUMENTS**

1,080,513	A *	12/1913	Jones	312/195
D196,733	S *	10/1963	Huller	D6/422
3,241,902	A *	3/1966	Lay et al.	312/219
D343,072	S *	1/1994	Schulman et al.	D6/425
2013/0169133	A1 *	7/2013	Johnson et al.	312/298

**OTHER PUBLICATIONS**

Q-Line Design SafeGuard Shelving System, screenshots and transcript written Matthew B. Dworman; posted on You Tube and website [www.qlinedesign.com](http://www qlinedesign.com) on Oct. 16, 2012.

(Continued)

*Primary Examiner* — Janice Seeger

(74) *Attorney, Agent, or Firm* — Z IP Law PLLC

(57) **CLAIM**

The ornamental design for a desk with hidden compartments, as shown and described.

**1 Claim, 16 Drawing Sheets**

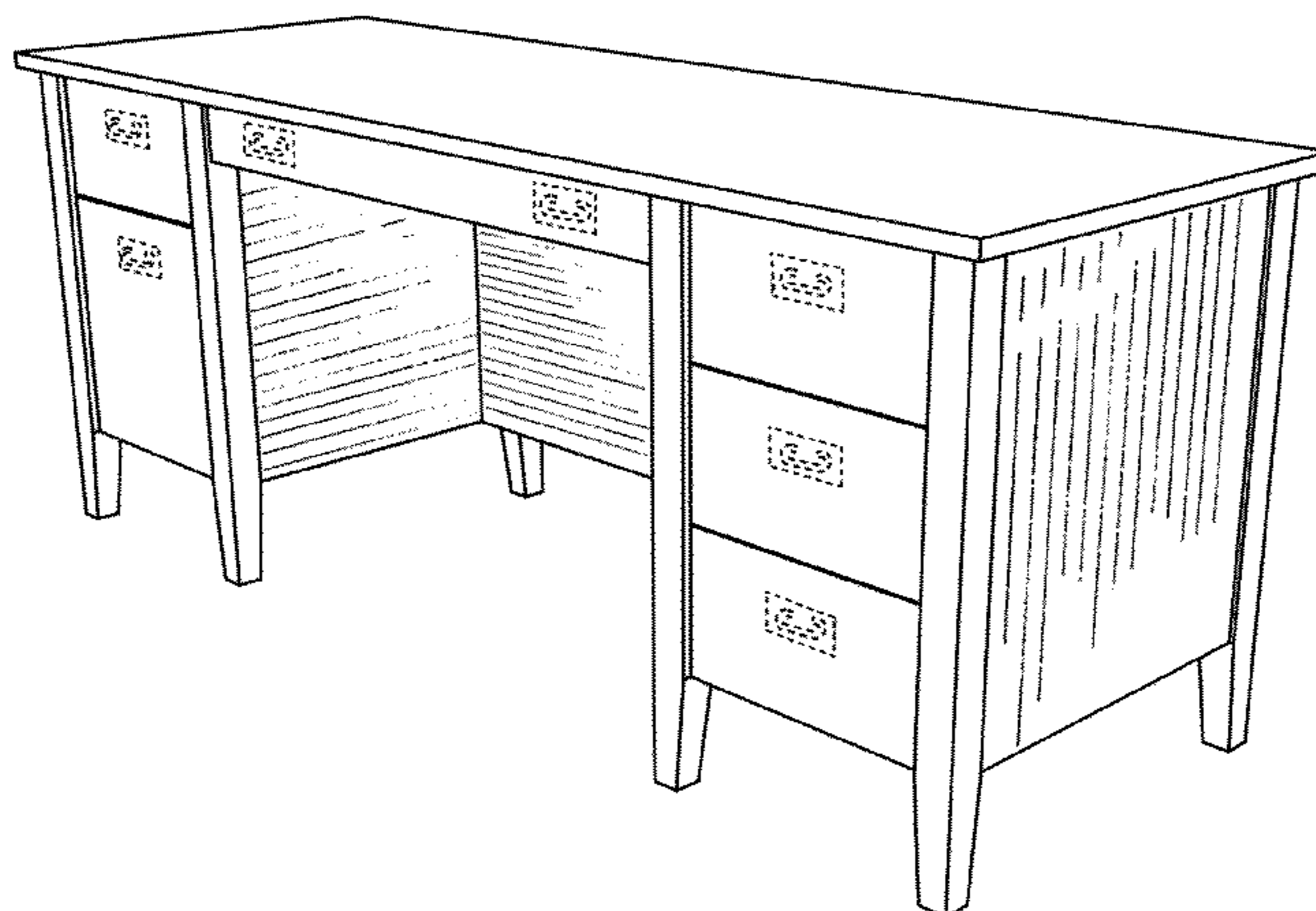

(56)

**References Cited**

OTHER PUBLICATIONS

Q-Line Design NightGuard End Table screenshots and transcript written Matthew B. Dworman; posted on You Tube and website [www.qlinedesign.com](http://www.qlinedesign.com) on Nov. 16, 2012.

Q-Line Design Entertainment Media Center screenshots and transcript written Matthew B. Dworman; posted on You Tube and website [www.qlinedesign.com](http://www.qlinedesign.com) on Jun. 20, 2013.

\* cited by examiner

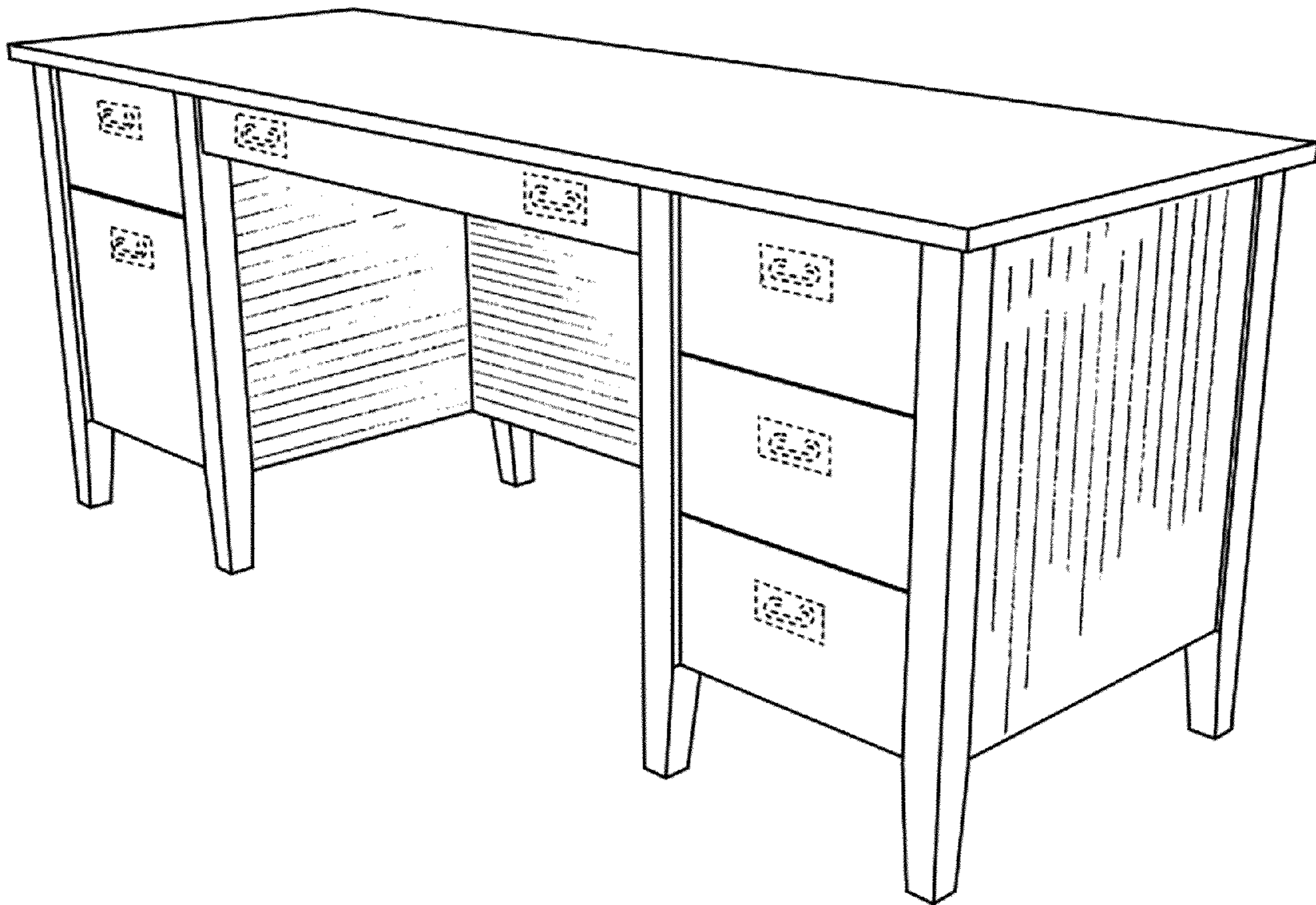

Fig. 1

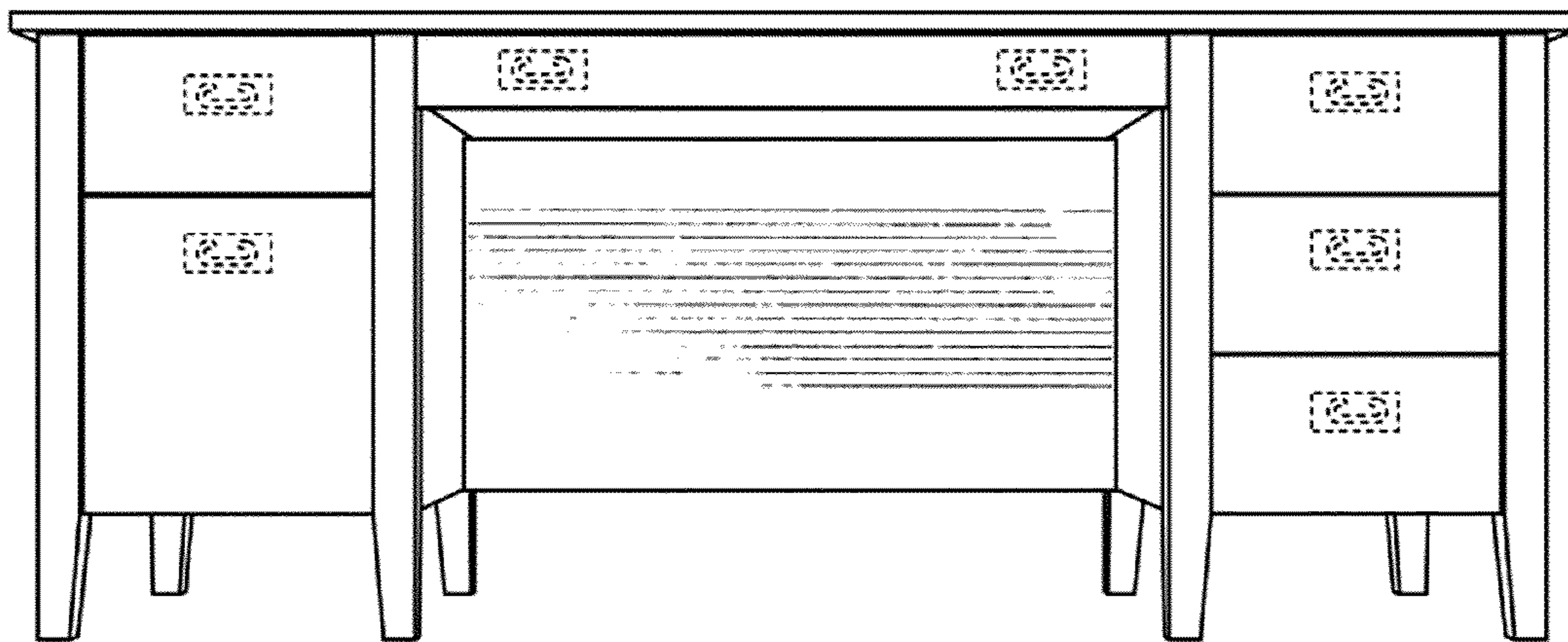

Fig. 2

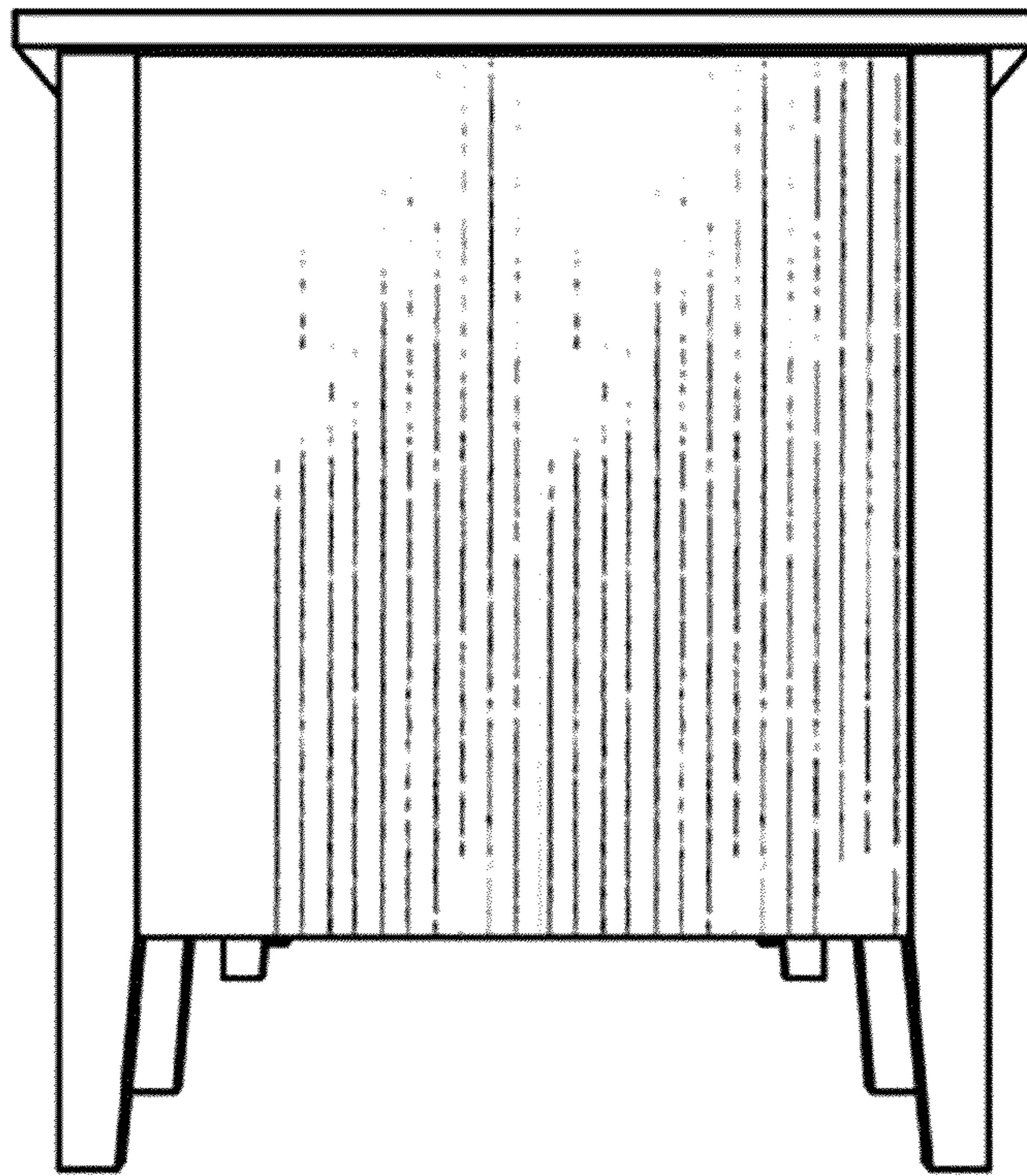

Fig. 3

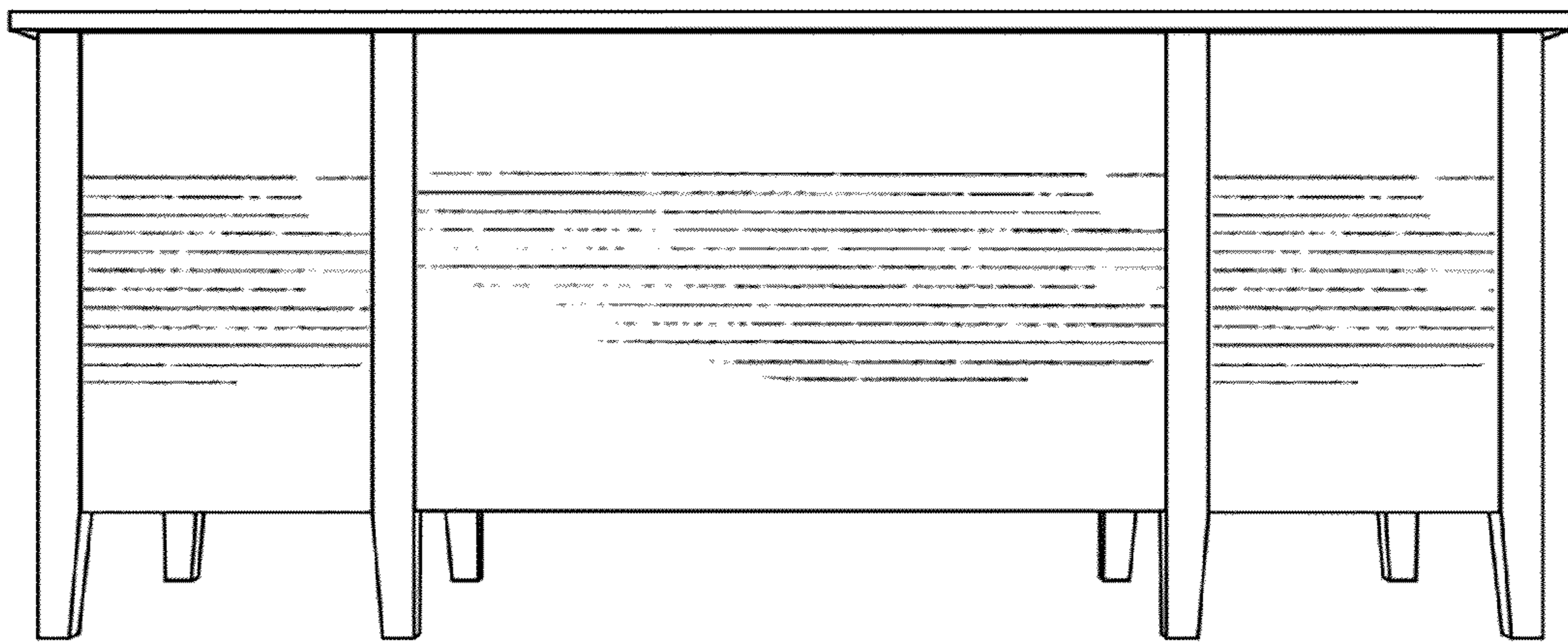

Fig. 4

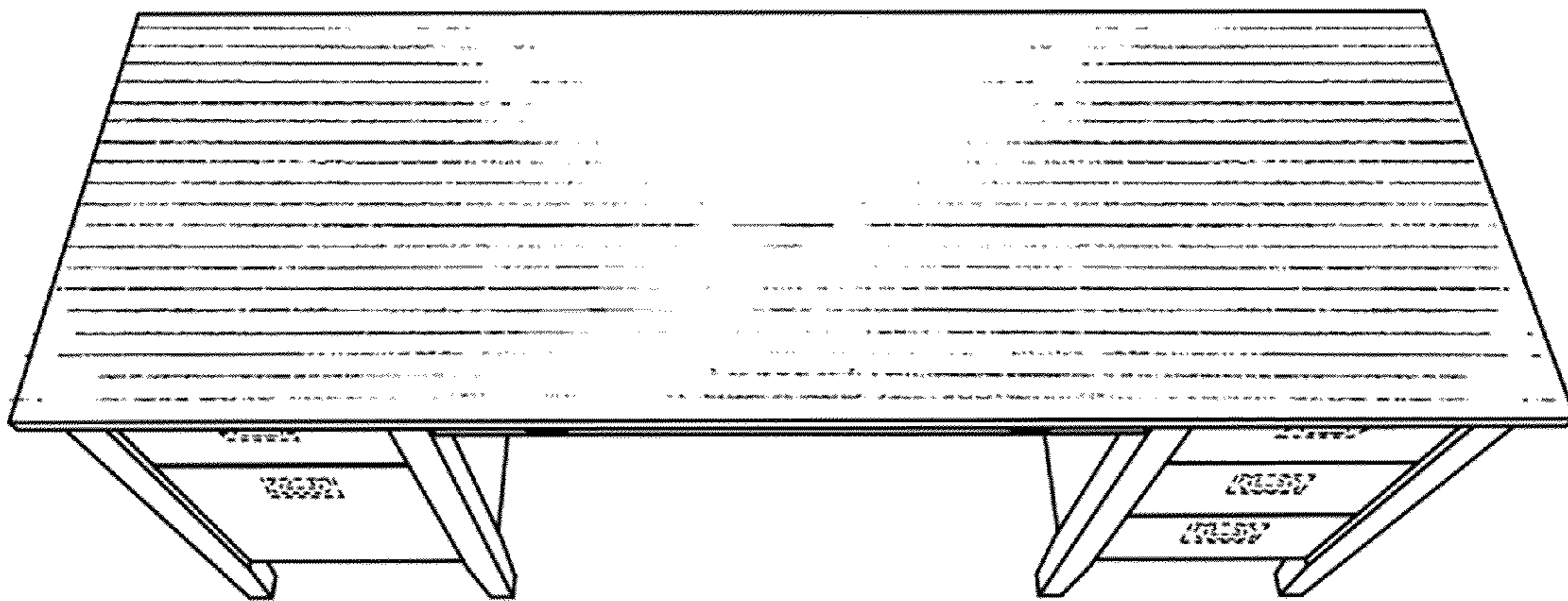

Fig. 5

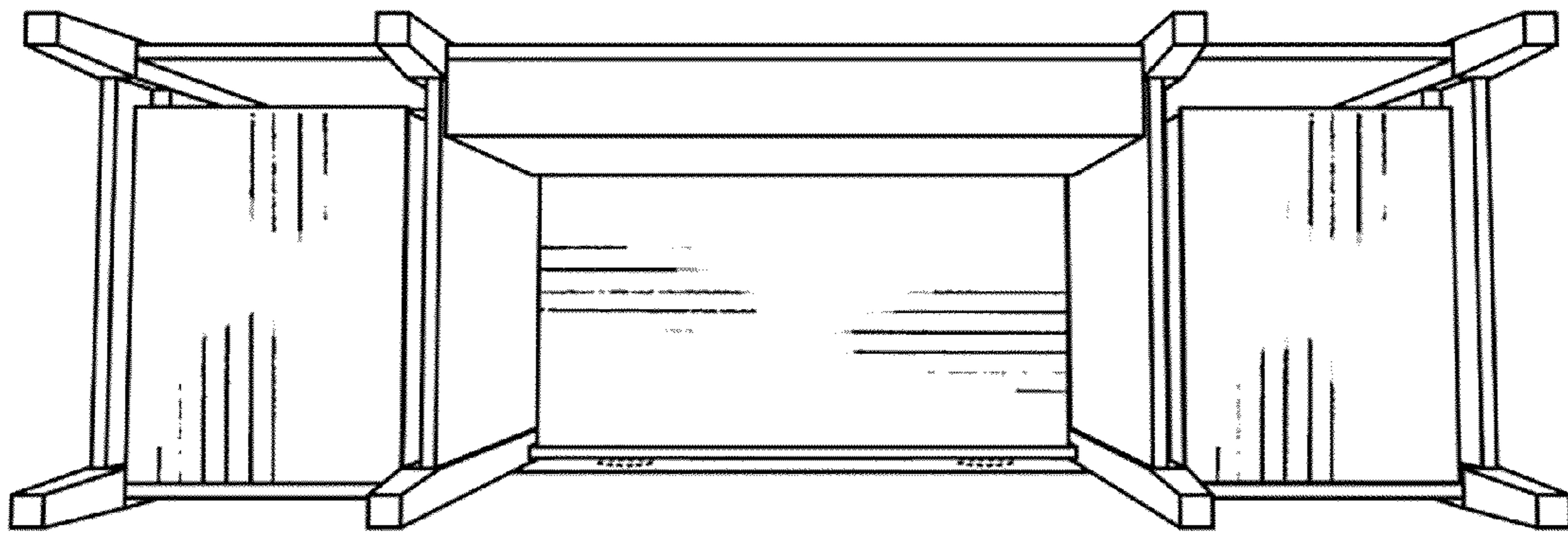

Fig. 6



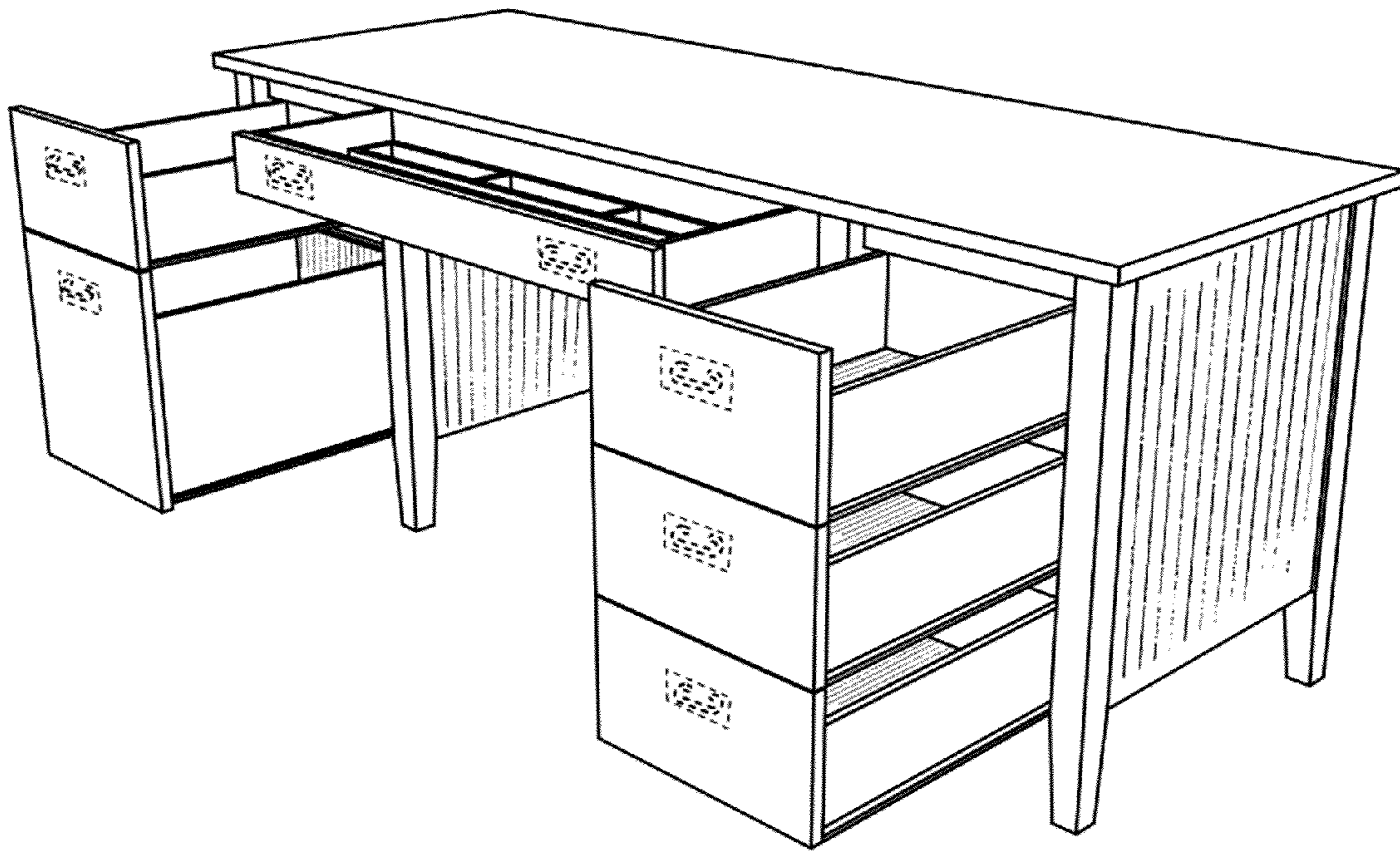

Fig. 7

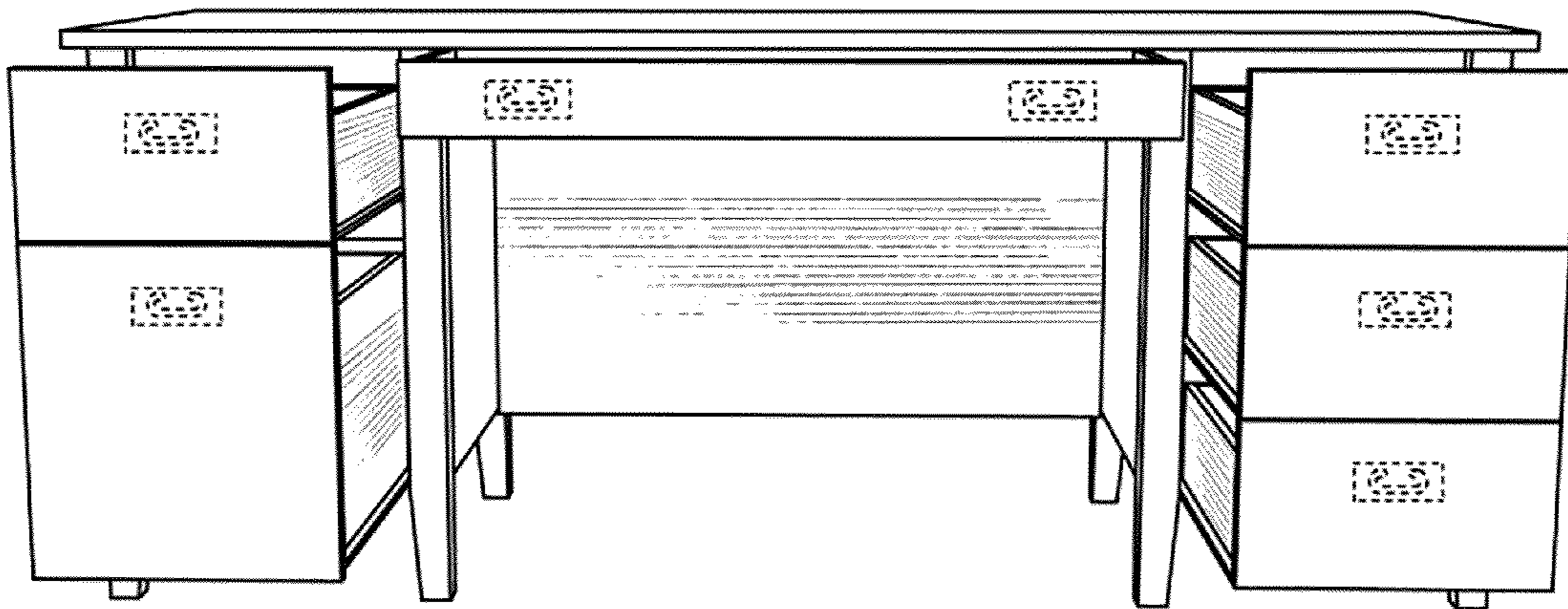

Fig. 8

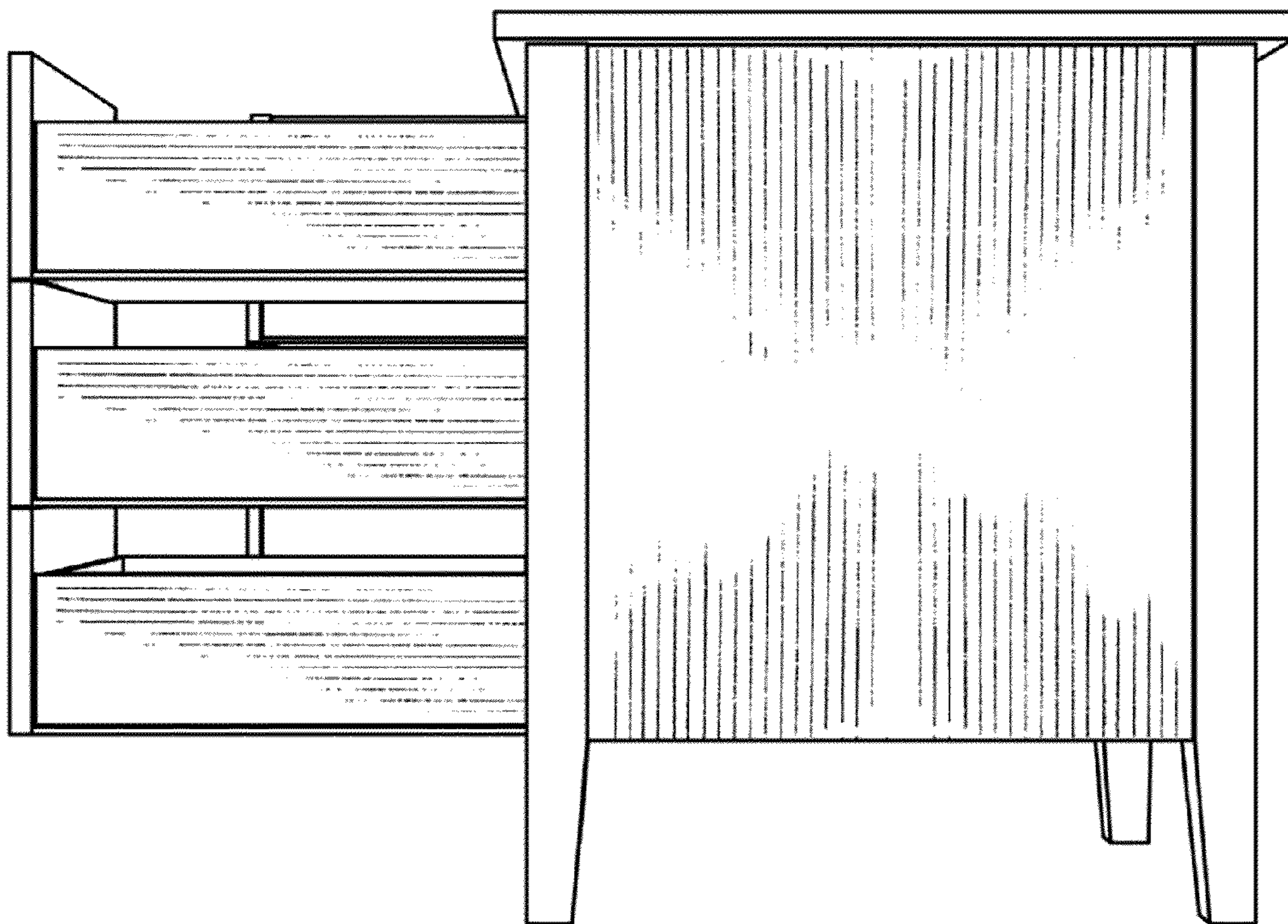

Fig. 9

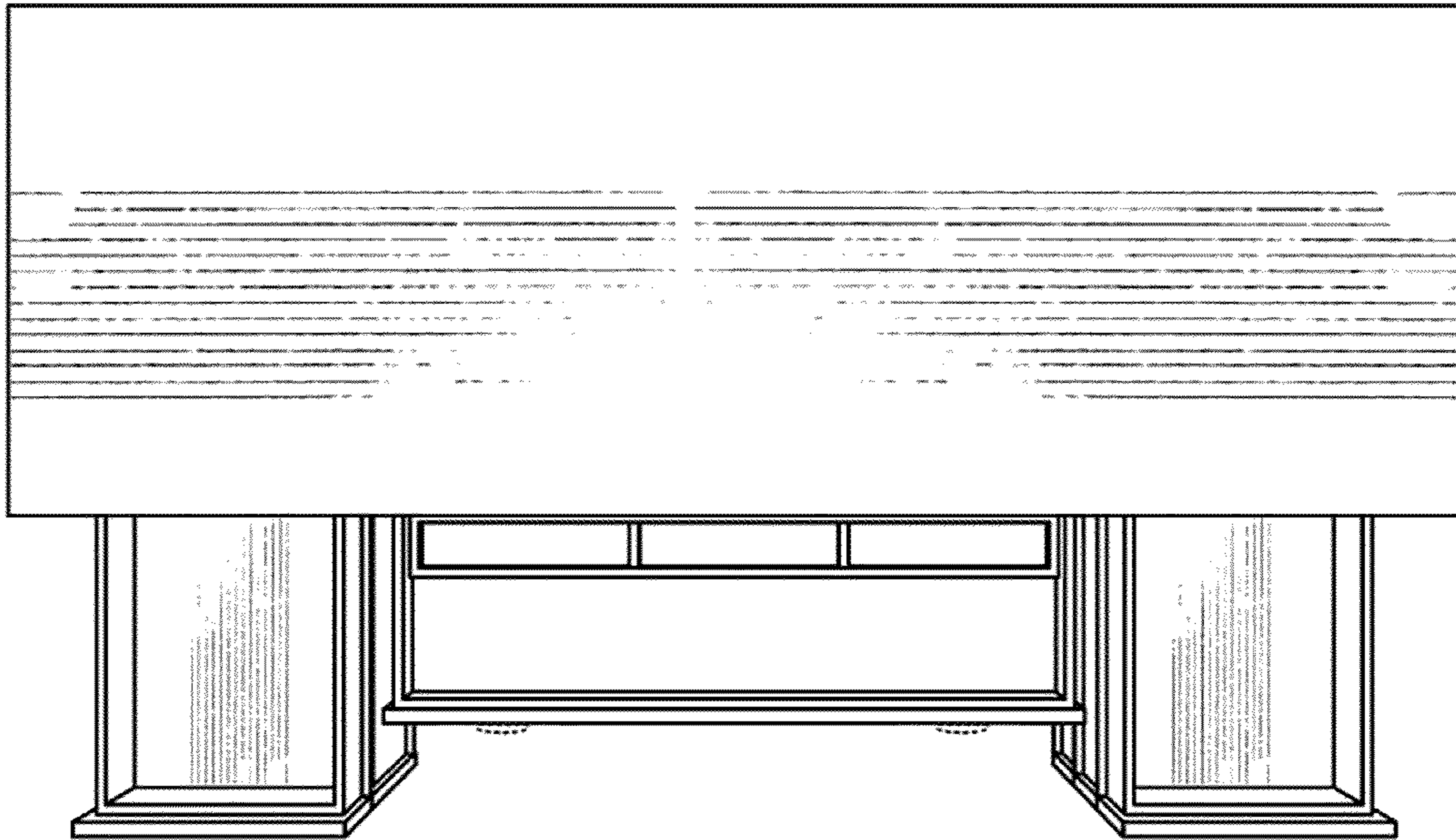

Fig. 10

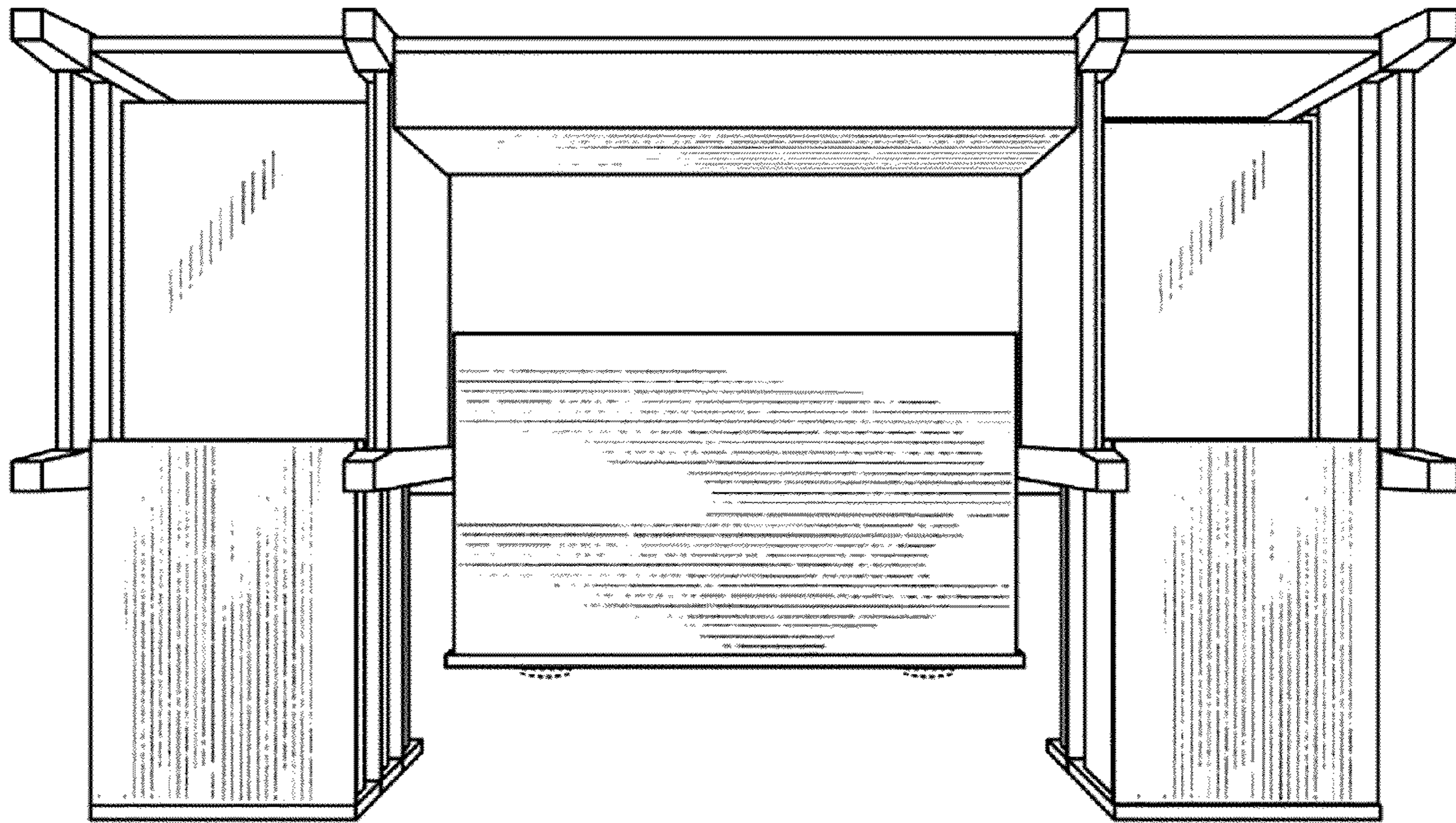

Fig. 11

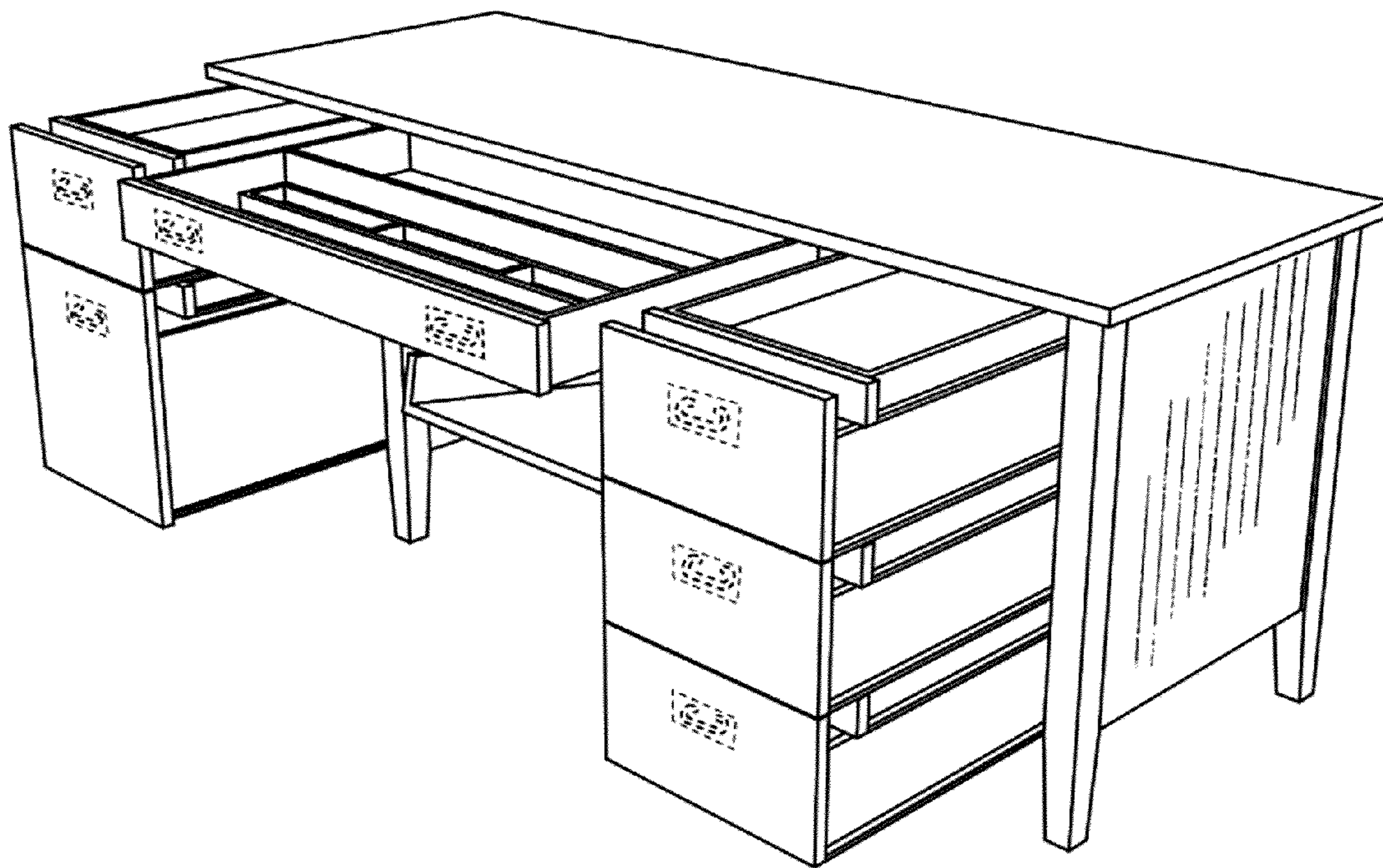

Fig. 12

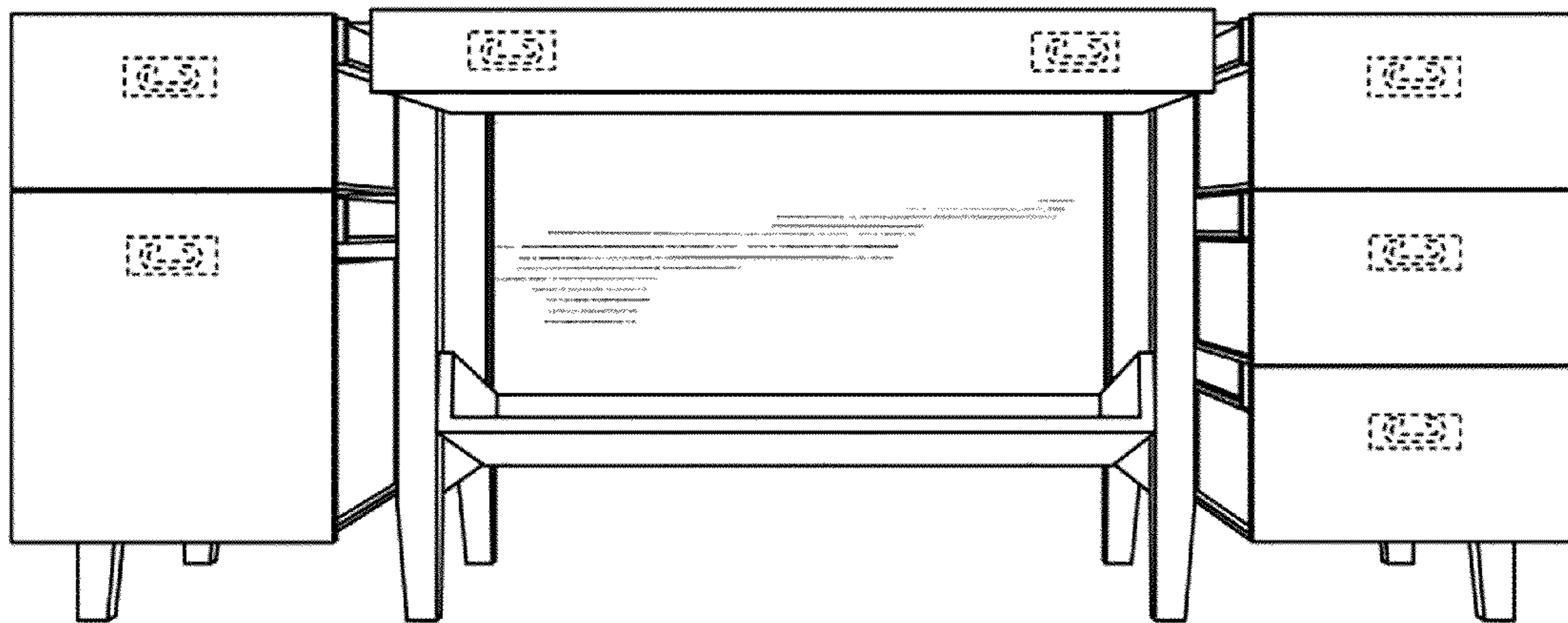

Fig. 13

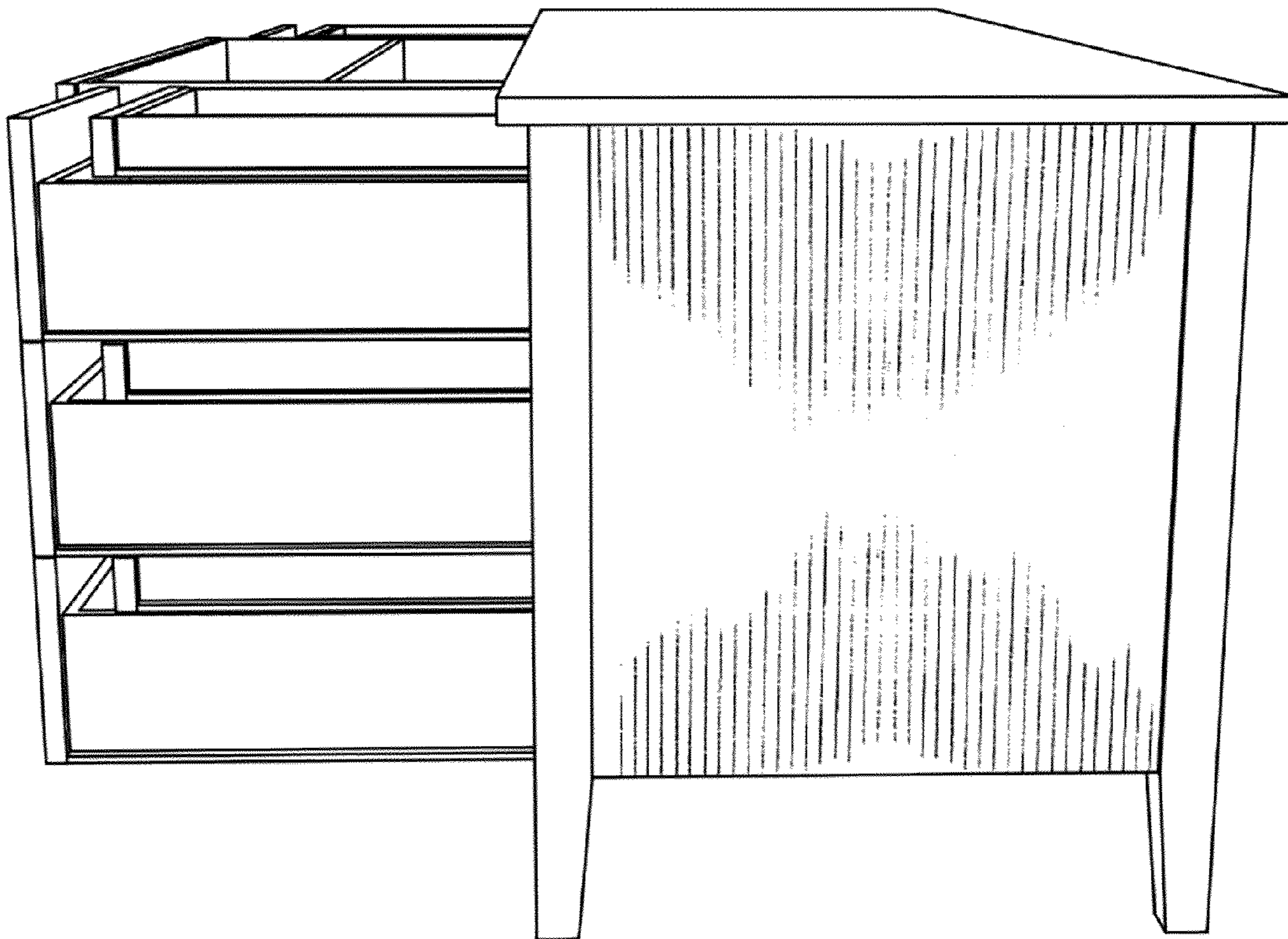

Fig. 14



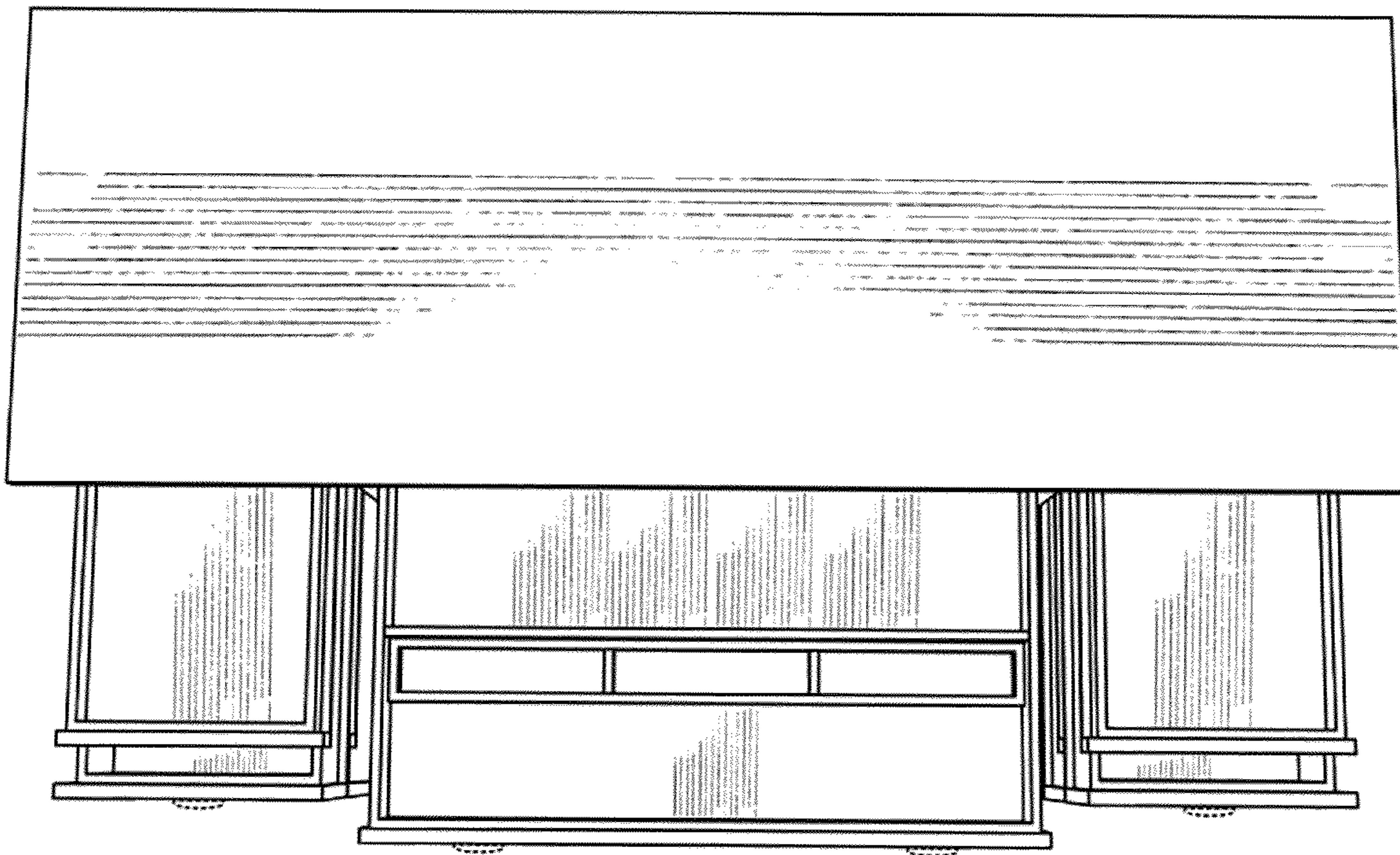

Fig. 15

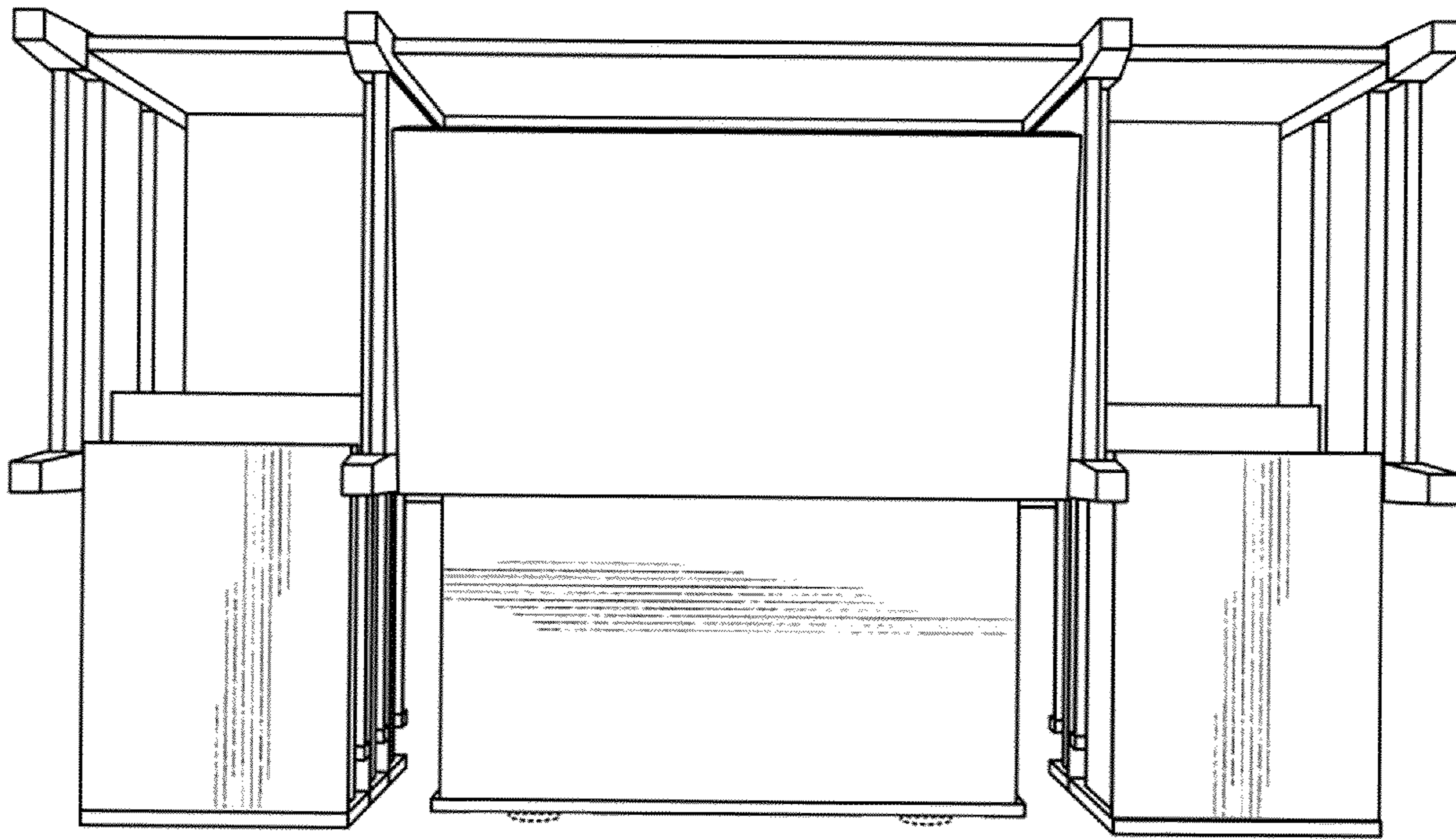

Fig. 16