



US00D735430S

(12) **United States Design Patent**  
**Miyazaki et al.**

(10) **Patent No.:** **US D735,430 S**  
(45) **Date of Patent:** **\*\* Jul. 28, 2015**

(54) **ROLLER SHAFT FOR SUBSTRATE  
CLEANING**

(71) Applicant: **EBARA CORPORATION**, Tokyo (JP)

(72) Inventors: **Mitsuru Miyazaki**, Tokyo (JP); **Takuya Inoue**, Tokyo (JP)

(73) Assignee: **EBARA CORPORATION**, Tokyo (JP)

(\*\*) Term: **14 Years**

(21) Appl. No.: **29/485,711**

(22) Filed: **Mar. 21, 2014**

(30) **Foreign Application Priority Data**

Sep. 24, 2013 (JP) ..... 2013-21974

(51) **LOC (10) Cl.** ..... **15-05**

(52) **U.S. Cl.**  
USPC ..... **D32/25**

(58) **Field of Classification Search**  
USPC ..... D32/1, 5, 25; 15/77, 88.2, 88.3, 102,  
15/230, 230.12, 230.14, 230.16; 134/6;  
451/194  
CPC ..... B08B 1/00; B08B 1/04; B24D 13/08;  
B24D 13/10  
See application file for complete search history.

(56) **References Cited**

**U.S. PATENT DOCUMENTS**

5,745,945	A *	5/1998	Manfredi et al.	15/77
6,240,588	B1 *	6/2001	Dickey et al.	15/88.3
6,247,197	B1 *	6/2001	Vail et al.	15/77
6,330,729	B1 *	12/2001	Brunelli et al.	15/102
6,464,796	B2 *	10/2002	Vail et al.	134/6
6,467,120	B1 *	10/2002	Ziemins et al.	15/102
6,502,273	B1 *	1/2003	Mihara et al.	15/230.16
6,523,210	B1 *	2/2003	Andros	15/102
6,543,084	B2 *	4/2003	Dickey et al.	15/88.3
6,598,255	B1 *	7/2003	Gohda et al.	15/102

6,616,516	B1 *	9/2003	Ravkin et al.	451/194
6,651,287	B2 *	11/2003	Oikawa et al.	15/102
6,684,447	B2 *	2/2004	Mihara et al.	15/230.16
6,802,099	B2 *	10/2004	Murakami et al.	15/102
6,842,933	B2 *	1/2005	Oikawa et al.	15/77
7,735,177	B1 *	6/2010	Farber et al.	15/102
7,908,698	B2 *	3/2011	Idani	15/77

(Continued)

**FOREIGN PATENT DOCUMENTS**

JP	14-39460	A	5/2012
JP	14-77720	A	8/2013
JP	14-77721	A	8/2013

*Primary Examiner* — Sandra Morris

(74) *Attorney, Agent, or Firm* — Pearne & Gordon LLP

(57) **CLAIM**

The ornamental design for a roller shaft for substrate cleaning, as shown and described.

**DESCRIPTION**

FIG. 1 is a left side view of a roller shaft for substrate cleaning showing our new design attached to a roller;  
FIG. 2 is a right side view thereof;  
FIG. 3 is a top view thereof, including a detail view of a portion thereof;  
FIG. 4 is a front view thereof, including a detail view of portion thereof;  
FIG. 5 is a cross-section view thereof, taken along the line 5-5 of FIG. 1;  
FIG. 6 is an enlarged top perspective view; and,  
FIG. 7 is an enlarged left side view thereof.

The portions of the roller shaft and the roller shown in broken lines are provided for illustrative purposes only and form no part of the claimed design.

The cross-section views are provided illustrative purposes only and the internal details of the roller shaft form no part of the claimed design. The hatching pattern used in these views does not represent any particular material.

**1 Claim, 7 Drawing Sheets**

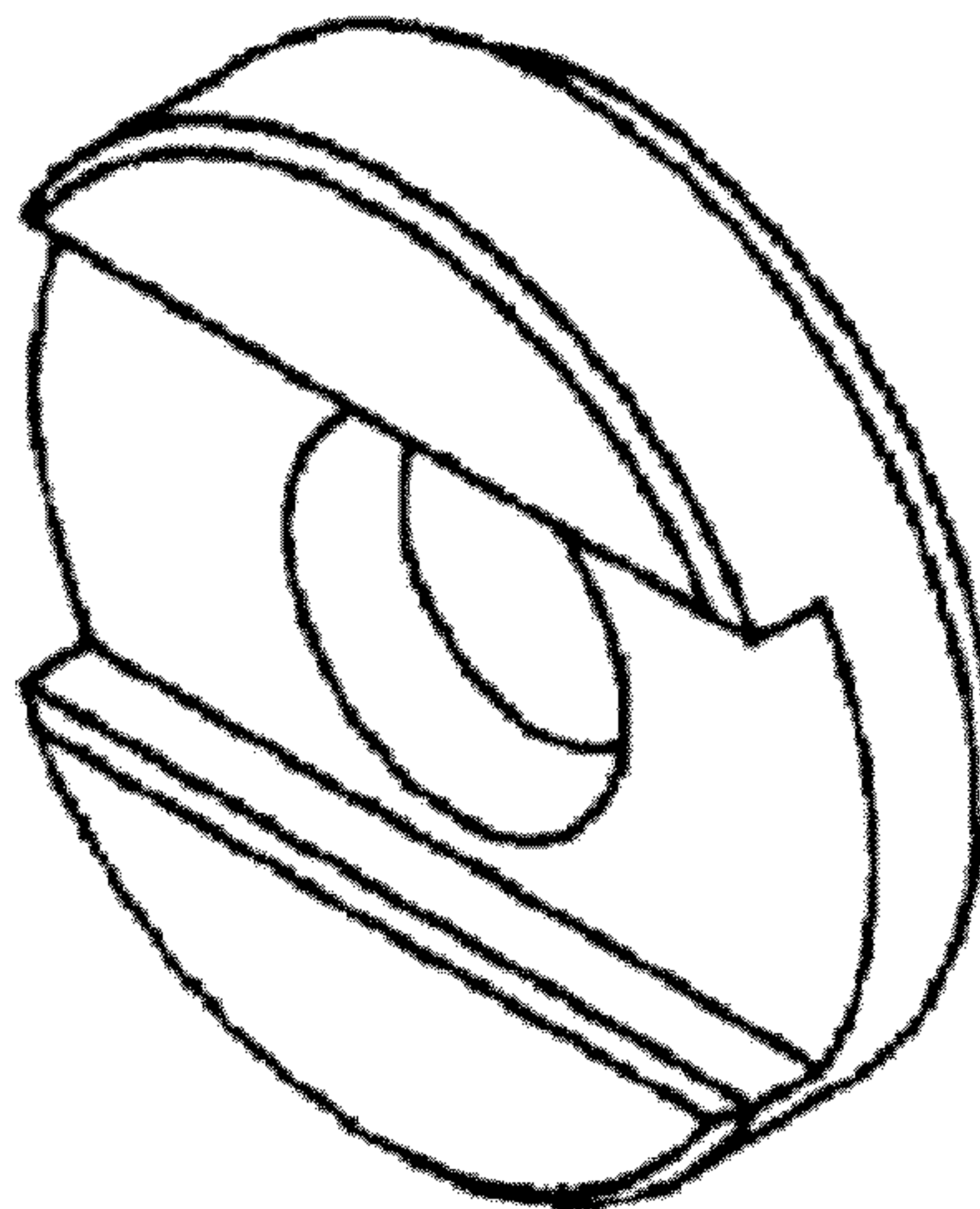

(56)

**References Cited**

U.S. PATENT DOCUMENTS

7,955,693 B2 *	6/2011	Drury	.....	15/103.5	8,460,475 B2 *	6/2013	Wargo et al.	.....	134/6
8,092,730 B2 *	1/2012	Wargo et al.	.....	15/102	8,496,758 B2 *	7/2013	Idani	.....	134/6
8,372,210 B2 *	2/2013	Sin et al.	.....	134/26	8,533,895 B2 *	9/2013	Benson	.....	15/230.16
8,444,890 B2 *	5/2013	Drury	.....	451/109	8,555,458 B2 *	10/2013	Kawaguchi et al.	.....	492/30
					D707,408 S *	6/2014	Ishibashi	.....	D32/25
					2013/0255720 A1 *	10/2013	Tyrrell et al.	.....	134/6
					2013/0255721 A1 *	10/2013	Tyrrell et al.	.....	134/6

\* cited by examiner

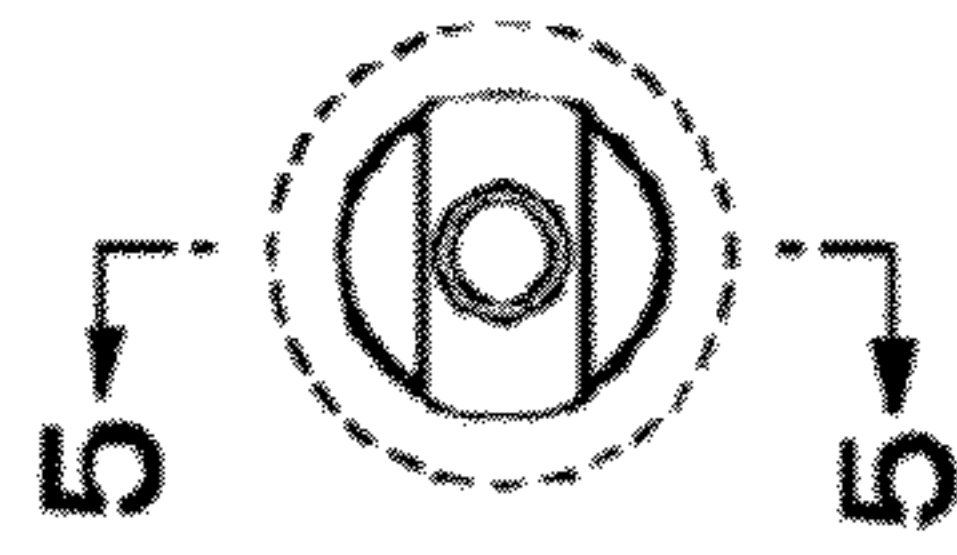

FIG.1

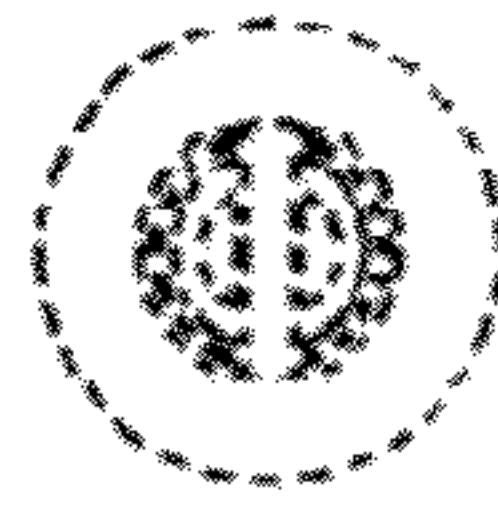

FIG.2

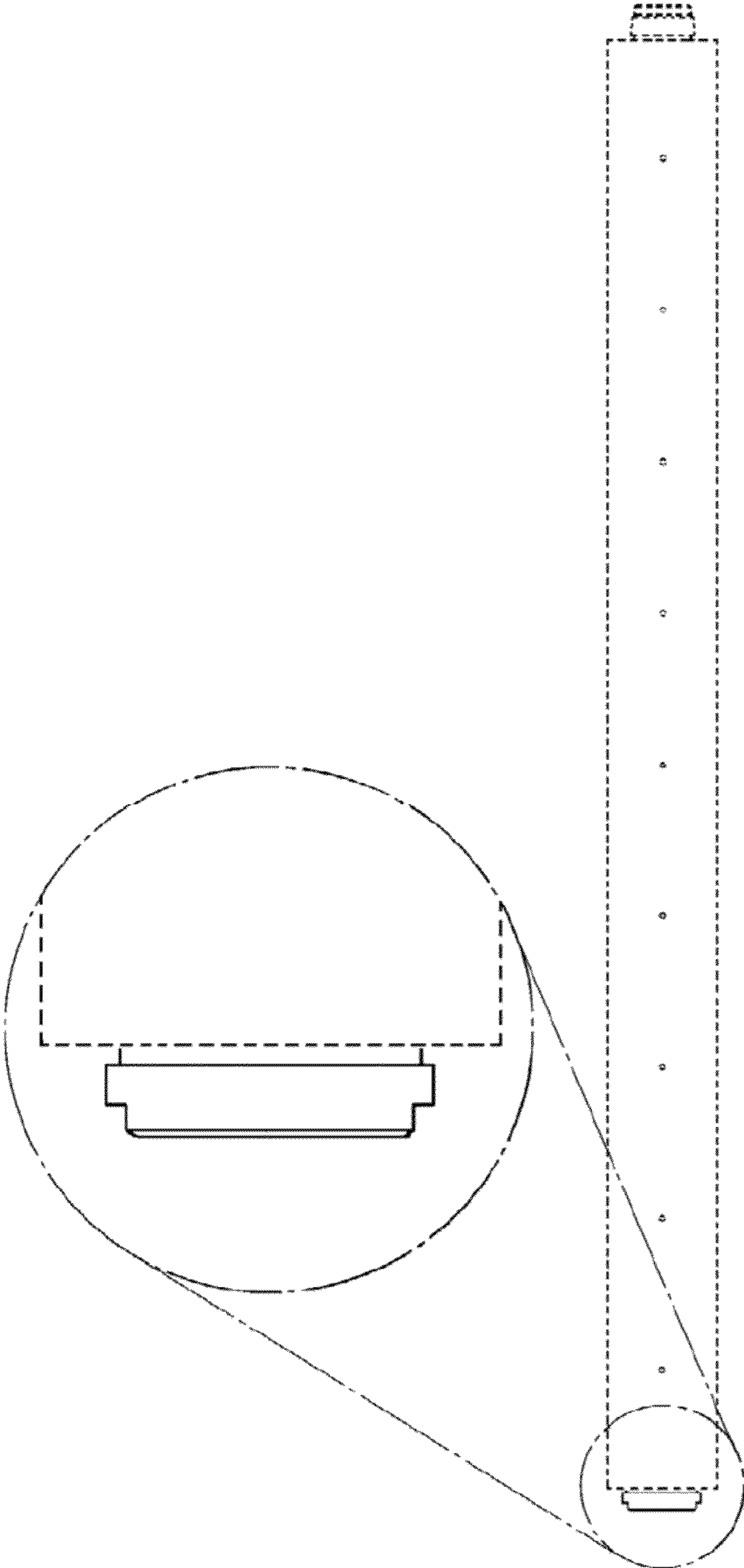

FIG.3

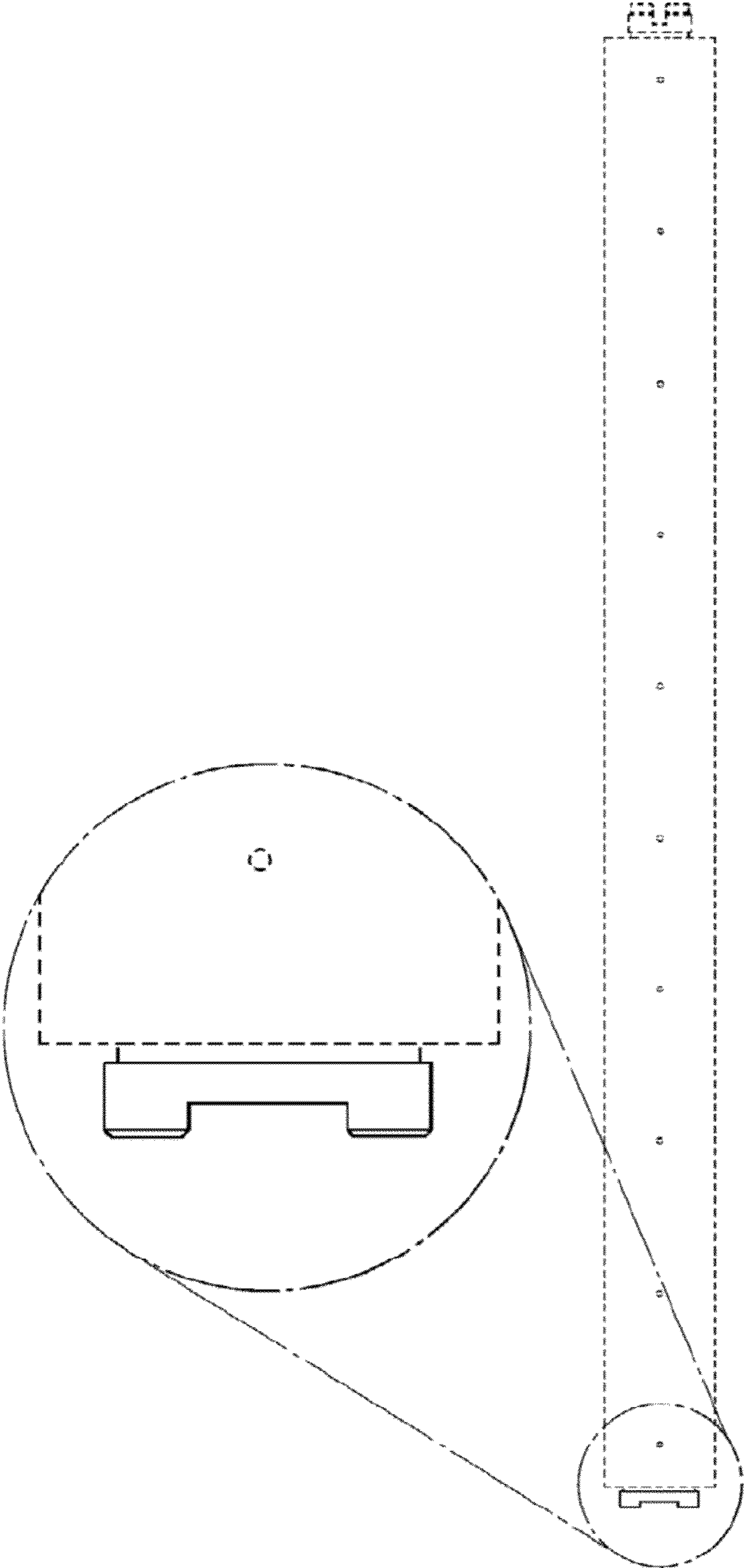

FIG.4



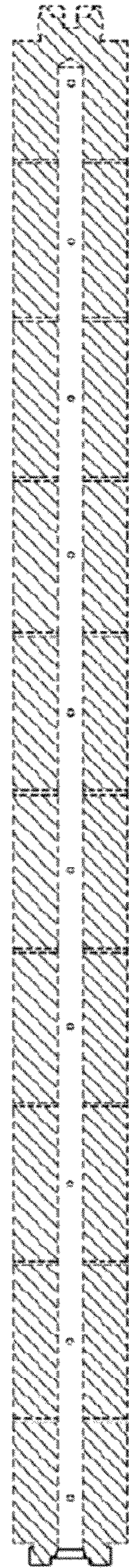

FIG.5

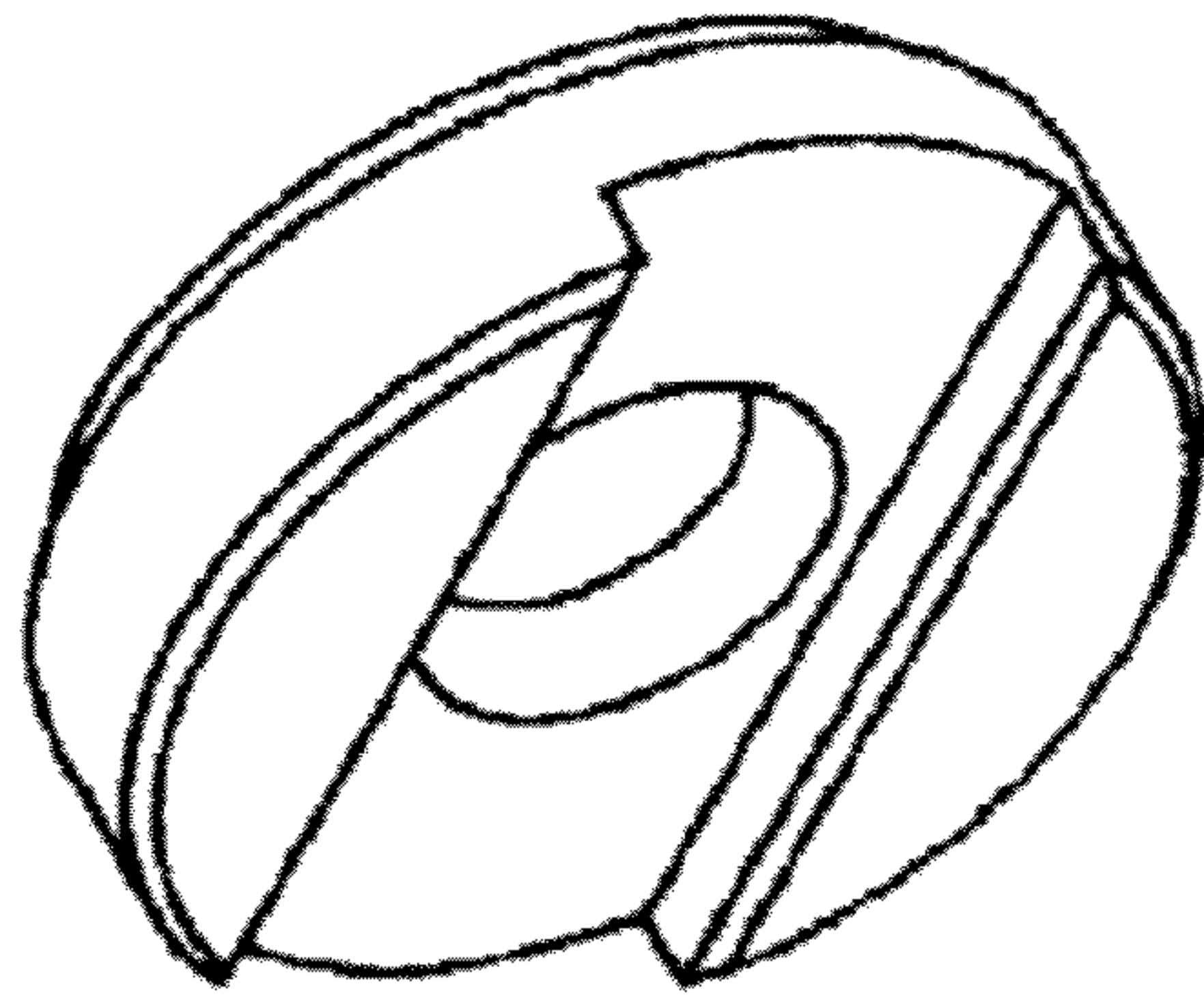

FIG. 6



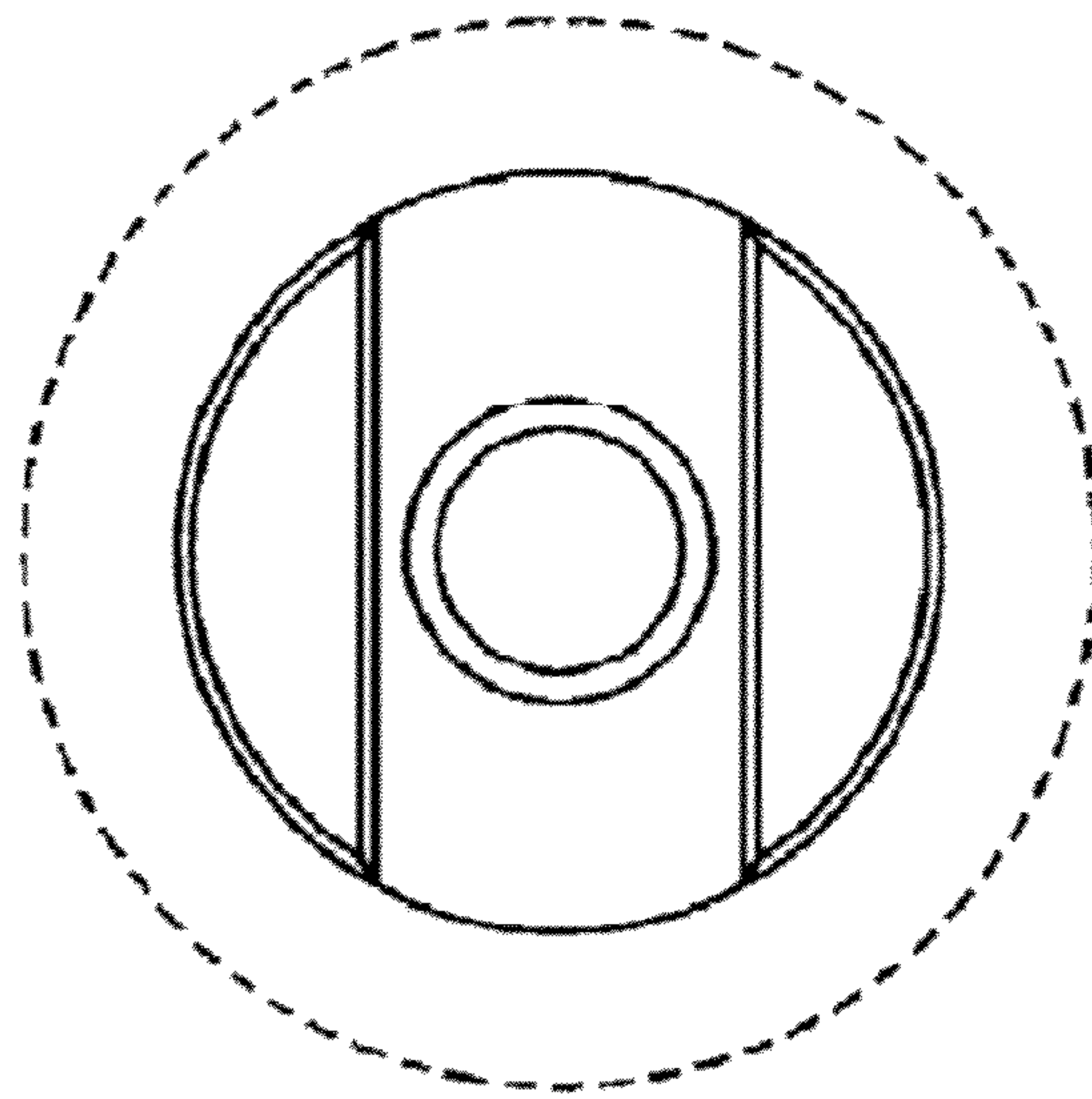

FIG. 7