



US00D735332S

(12) **United States Design Patent**
Allen et al.

(10) **Patent No.:** **US D735,332 S**
(45) **Date of Patent:** **** Jul. 28, 2015**

- (54) **BIOPSY DEVICE**
- (71) Applicant: **C. R. Bard, Inc.**, Tempe, AZ (US)
- (72) Inventors: **Timothy Samuel Allen**, Scottsdale, AZ (US); **Chad Christopher Van Liere**, Phoenix, AZ (US)
- (73) Assignee: **C. R. Bard, Inc.**, Murray Hill, NJ (US)
- (**) Term: **14 Years**

5,335,671 A	8/1994	Clement	
5,335,672 A	8/1994	Bennett	
5,353,804 A	10/1994	Kornberg et al.	
5,368,045 A	11/1994	Clement et al.	
5,400,798 A	3/1995	Baran	
5,476,101 A	12/1995	Schramm et al.	
5,492,130 A	2/1996	Chiou	
5,507,298 A	4/1996	Schramm et al.	
5,515,861 A	5/1996	Smith	
D372,310 S *	7/1996	Hartnett	D24/146
5,546,957 A	8/1996	Heske	
5,655,542 A	8/1997	Weilandt	

(Continued)

- (21) Appl. No.: **29/447,702**
- (22) Filed: **Mar. 6, 2013**
- (51) **LOC (10) Cl.** **24-02**
- (52) **U.S. Cl.**
USPC **D24/147**
- (58) **Field of Classification Search**
USPC D7/649; D8/14.1, 29.1, 92, 93, 95, 97, D8/98, 99; D19/110, 115; D24/130, 133, D24/146, 147, 150, 151; 30/151, 162, 338, 30/339; 606/4, 5, 6, 44, 107, 166
See application file for complete search history.

FOREIGN PATENT DOCUMENTS

WO	2005072621 A1	8/2005
WO	2006022699 A1	3/2006
WO	2013158072 A1	10/2013

Primary Examiner — Robert M Spear
Assistant Examiner — Marissa J Cash

(57) **CLAIM**
The ornamental design for a biopsy device, as shown and described.

DESCRIPTION

FIG. 1 is a perspective view of a biopsy device showing our new design;
FIG. 2 is a top view of the biopsy device of FIG. 1;
FIG. 3 is a right side view of the biopsy device of FIG. 1, the left side view being identical;
FIG. 4 is a bottom view of the biopsy device of FIG. 1;
FIG. 5 is an end view of the biopsy device of FIG. 1 as viewed from the proximal end of the biopsy device; and,
FIG. 6 is an end view of the biopsy device of FIG. 1 as viewed from the distal end of the biopsy device.
The broken lines in the drawings represent unclaimed environmental subject matter and form no part of the claim.

1 Claim, 5 Drawing Sheets

- (56) **References Cited**
U.S. PATENT DOCUMENTS
- | | | | |
|--------------|---------|----------------------|---------|
| 3,561,429 A | 2/1971 | Jewett | |
| D295,315 S * | 4/1988 | Nelson | D24/130 |
| 4,881,551 A | 11/1989 | Taylor | |
| 4,907,599 A | 3/1990 | Taylor | |
| 4,944,308 A | 7/1990 | Akerfeldt | |
| 4,950,265 A | 8/1990 | Taylor | |
| 4,953,558 A | 9/1990 | Akerfeldt | |
| D315,407 S * | 3/1991 | Bradrick et al. | D24/130 |
| 5,156,160 A | 10/1992 | Bennett | |
| 5,213,110 A | 5/1993 | Kedem et al. | |
| 5,224,470 A | 7/1993 | Schnepp-Pesch et al. | |
| 5,249,583 A | 10/1993 | Mallaby | |
| 5,284,156 A | 2/1994 | Schramm et al. | |

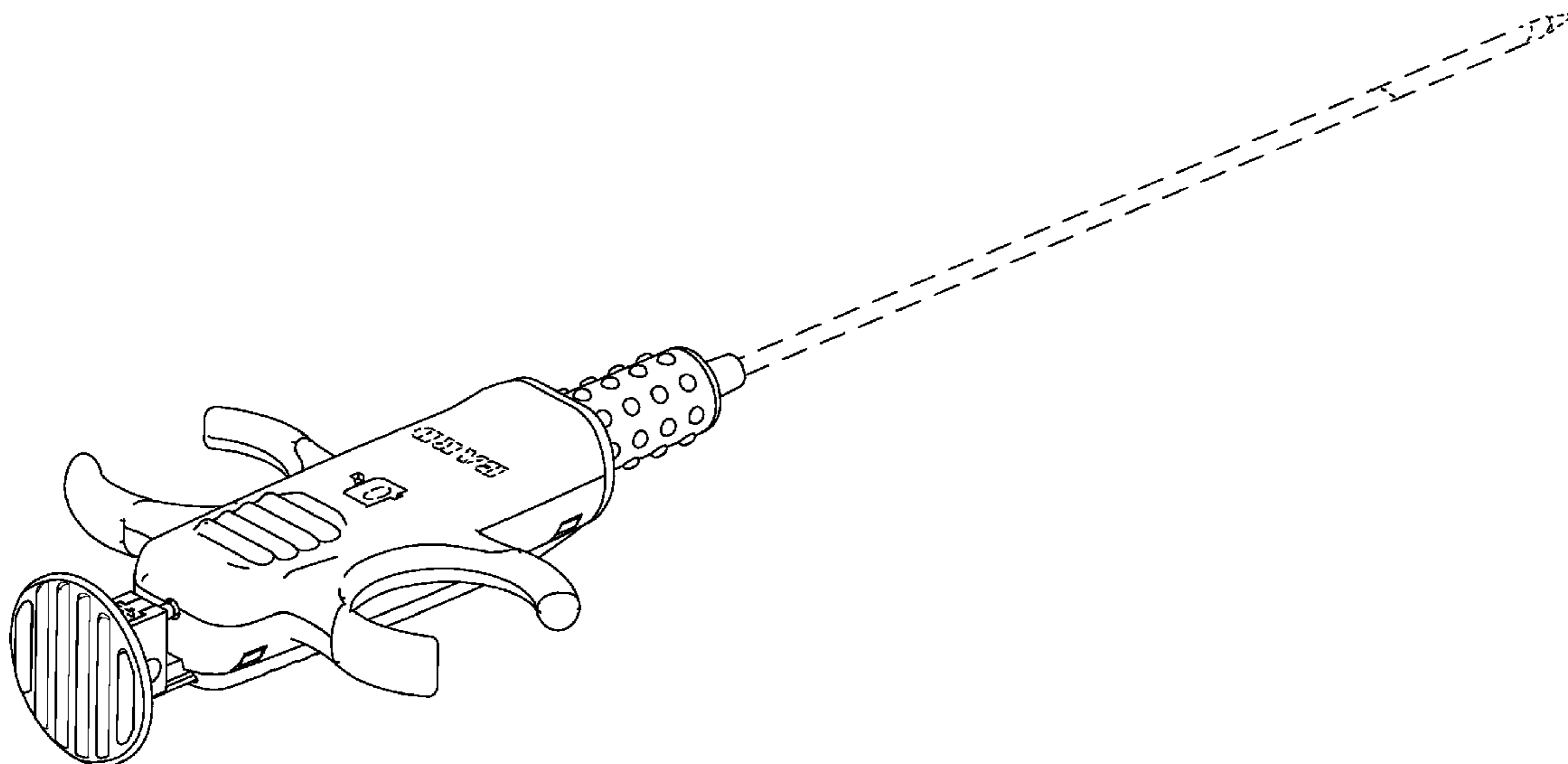

(56)

References Cited

U.S. PATENT DOCUMENTS

5,817,033 A	10/1998	DeSantis et al.	8,246,551 B2	8/2012	Miller et al.
5,842,999 A	12/1998	Pruitt et al.	8,251,917 B2	8/2012	Almazan
5,916,175 A	6/1999	Bauer	8,262,586 B2	9/2012	Anderson et al.
5,951,489 A	9/1999	Bauer	8,277,394 B2	10/2012	Hibner
5,954,670 A	9/1999	Baker	8,287,465 B2	10/2012	Hardin et al.
5,971,939 A	10/1999	DeSantis et al.	8,328,836 B2	12/2012	Conlon et al.
5,989,196 A	11/1999	Chu et al.	8,343,072 B2	1/2013	Bacon et al.
5,989,197 A	11/1999	Avaltroni	8,357,104 B2	1/2013	Moos et al.
6,007,497 A	12/1999	Huitema	D699,348 S *	2/2014	Morejon D24/147
6,165,136 A	12/2000	Nishtala	2003/0163062 A1	8/2003	Bauer
6,283,925 B1	9/2001	Terwilliger	2004/0167429 A1	8/2004	Roshdieh et al.
6,346,085 B1	2/2002	Schiffman	2004/0215174 A1*	10/2004	Morawski et al. 606/4
6,358,217 B1	3/2002	Bourassa	2004/0267154 A1	12/2004	Sutton et al.
6,436,054 B1	8/2002	Viola et al.	2005/0054947 A1	3/2005	Goldenberg
6,592,530 B1	7/2003	Farhadi	2005/0054948 A1	3/2005	Goldenberg
6,749,576 B2	6/2004	Bauer	2005/0075580 A1	4/2005	Leigh et al.
6,758,824 B1	7/2004	Miller et al.	2006/0116604 A1	6/2006	Adams et al.
RE38,776 E	8/2005	Bauer	2006/0130338 A1*	6/2006	Dzubak et al. 30/162
6,984,213 B2	1/2006	Horner et al.	2006/0276747 A1	12/2006	Moos et al.
7,008,382 B2	3/2006	Adams et al.	2007/0167868 A1	7/2007	Sauer
7,153,275 B2	12/2006	Blondeau	2007/0213635 A1	9/2007	Hancock
7,156,815 B2	1/2007	Leigh et al.	2007/0239064 A1	10/2007	Cicenas et al.
7,179,232 B2	2/2007	Sutton et al.	2007/0239065 A1	10/2007	Zadow
7,278,970 B2	10/2007	Goldenberg	2007/0255306 A1	11/2007	Conlon et al.
7,329,227 B2	2/2008	Schramm	2008/0214955 A1	9/2008	Speeg et al.
7,402,140 B2	7/2008	Spero et al.	2008/0228103 A1	9/2008	Ritchie et al.
7,449,000 B2	11/2008	Adams et al.	2008/0228198 A1*	9/2008	Traynor et al. 606/138
7,465,278 B2	12/2008	Cicenas et al.	2009/0024056 A1	1/2009	Bacon et al.
7,468,041 B2	12/2008	Rhodes et al.	2009/0118641 A1	5/2009	Van Dam et al.
7,470,237 B2	12/2008	Beckman et al.	2009/0264794 A1	10/2009	Kodama
7,479,117 B2	1/2009	Zadow	2010/0030104 A1	2/2010	Hardin et al.
7,481,775 B2	1/2009	Weikel, Jr. et al.	2010/0030108 A1	2/2010	Anderson et al.
7,507,210 B2	3/2009	Hibner et al.	2010/0042014 A1	2/2010	Djordjevic et al.
7,585,282 B2	9/2009	Hancock	2010/0121218 A1	5/2010	Mugan et al.
7,608,048 B2	10/2009	Goldenberg	2010/0152611 A1	6/2010	Parihar et al.
7,611,475 B2	11/2009	Spero et al.	2010/0280410 A1	11/2010	Moos et al.
7,766,843 B2	8/2010	Voegele	2010/0312141 A1	12/2010	Keast et al.
7,828,747 B2	11/2010	Heske et al.	2011/0021946 A1	1/2011	Heske et al.
7,837,630 B2	11/2010	Nicoson et al.	2011/0125054 A1	5/2011	Clements et al.
7,914,464 B2	3/2011	Burdorff et al.	2011/0152715 A1	6/2011	Delap et al.
7,938,786 B2	5/2011	Ritchie et al.	2011/0190660 A1	8/2011	Levy
7,988,642 B2	8/2011	Hardin et al.	2012/0071787 A1	3/2012	Reuber et al.
8,088,080 B2	1/2012	Adams et al.	2012/0116248 A1	5/2012	McWeeney et al.
8,109,885 B2	2/2012	Heske et al.	2012/0130275 A1	5/2012	Chudzik et al.
8,162,850 B2	4/2012	Parihar et al.	2012/0179065 A1	7/2012	Ferree et al.
8,162,851 B2	4/2012	Heske et al.	2012/0215130 A1	8/2012	Field et al.
8,187,294 B2	5/2012	Miller et al.	2012/0253230 A1	10/2012	Williams et al.
8,192,369 B2	6/2012	Bacon et al.	2013/0023790 A1	1/2013	Schaeffer
8,197,419 B2	6/2012	Field et al.	2013/0053725 A1	2/2013	Beck et al.
			2013/0060161 A1	3/2013	Bacon

* cited by examiner

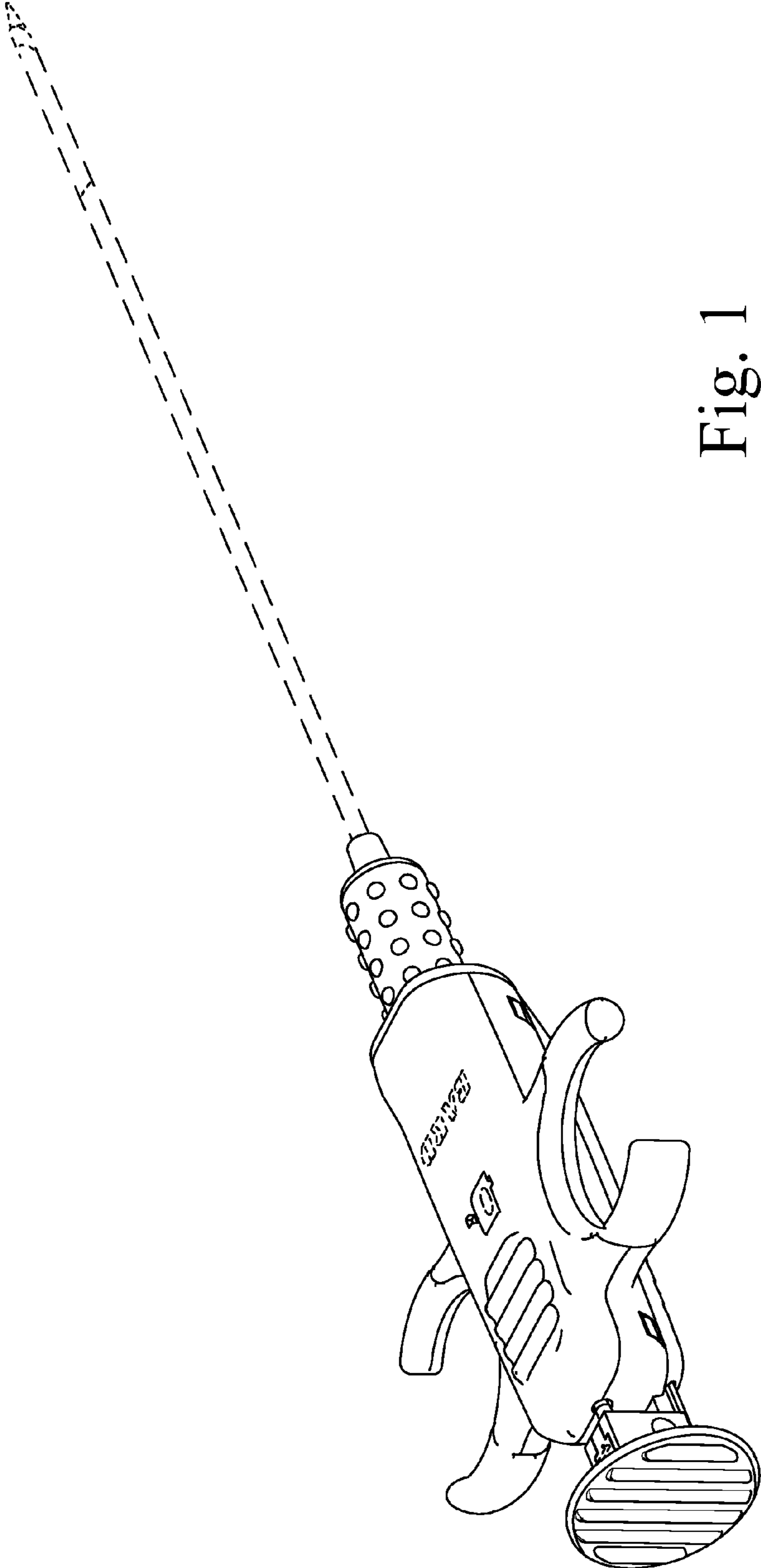

Fig. 1

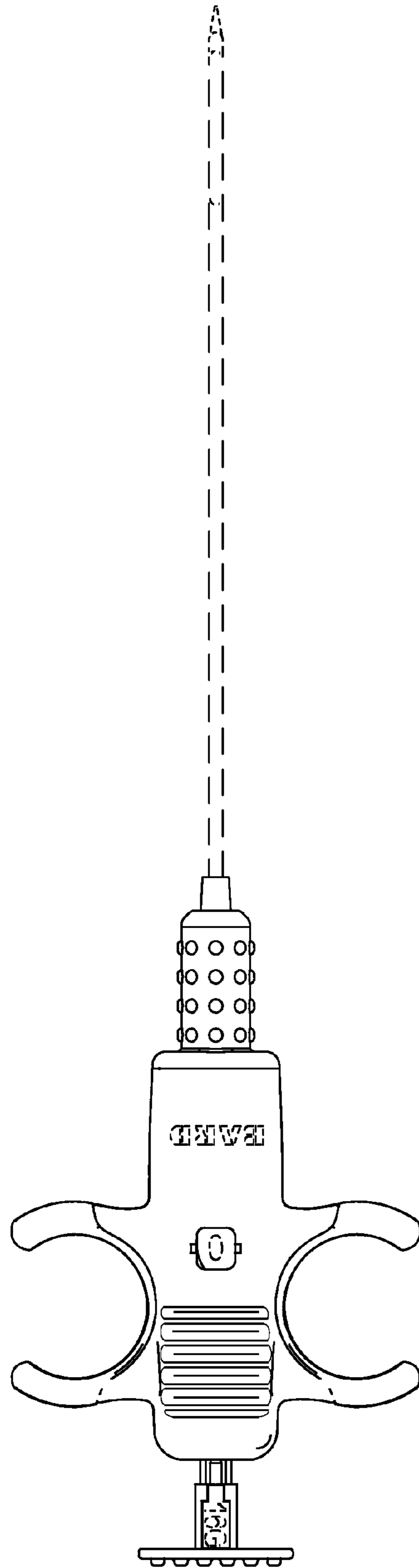

Fig. 2

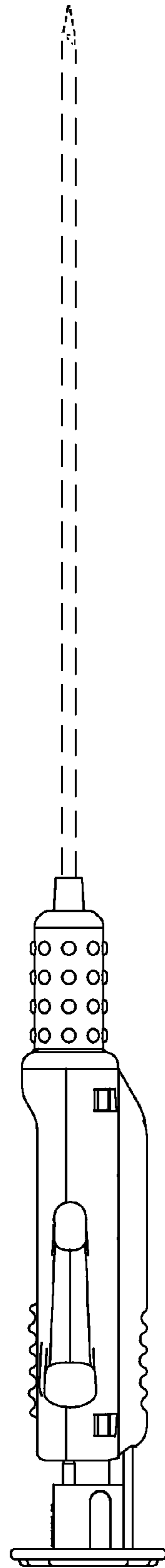

Fig. 3

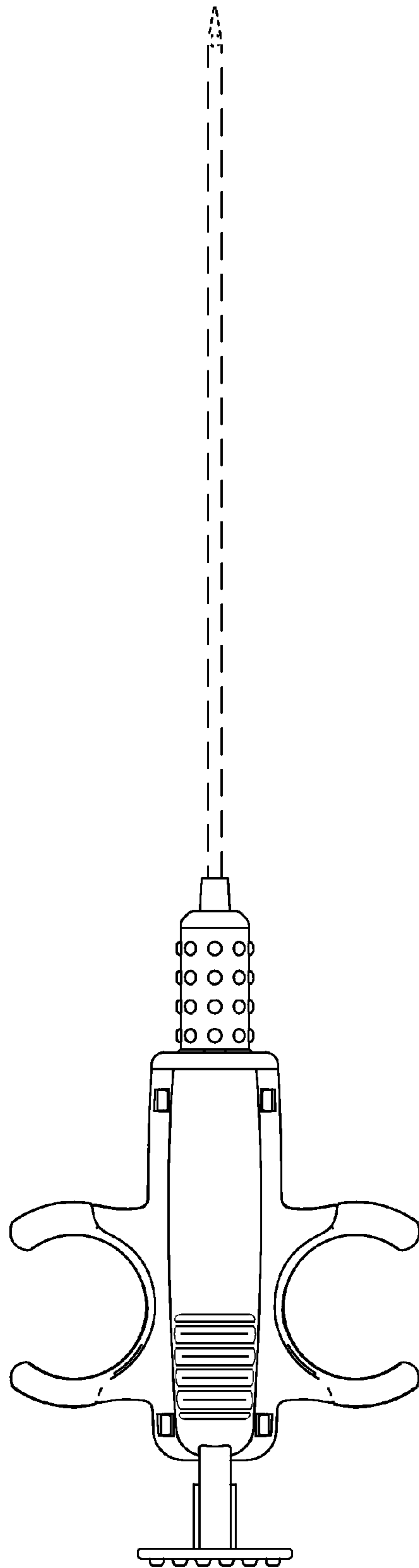

Fig. 4

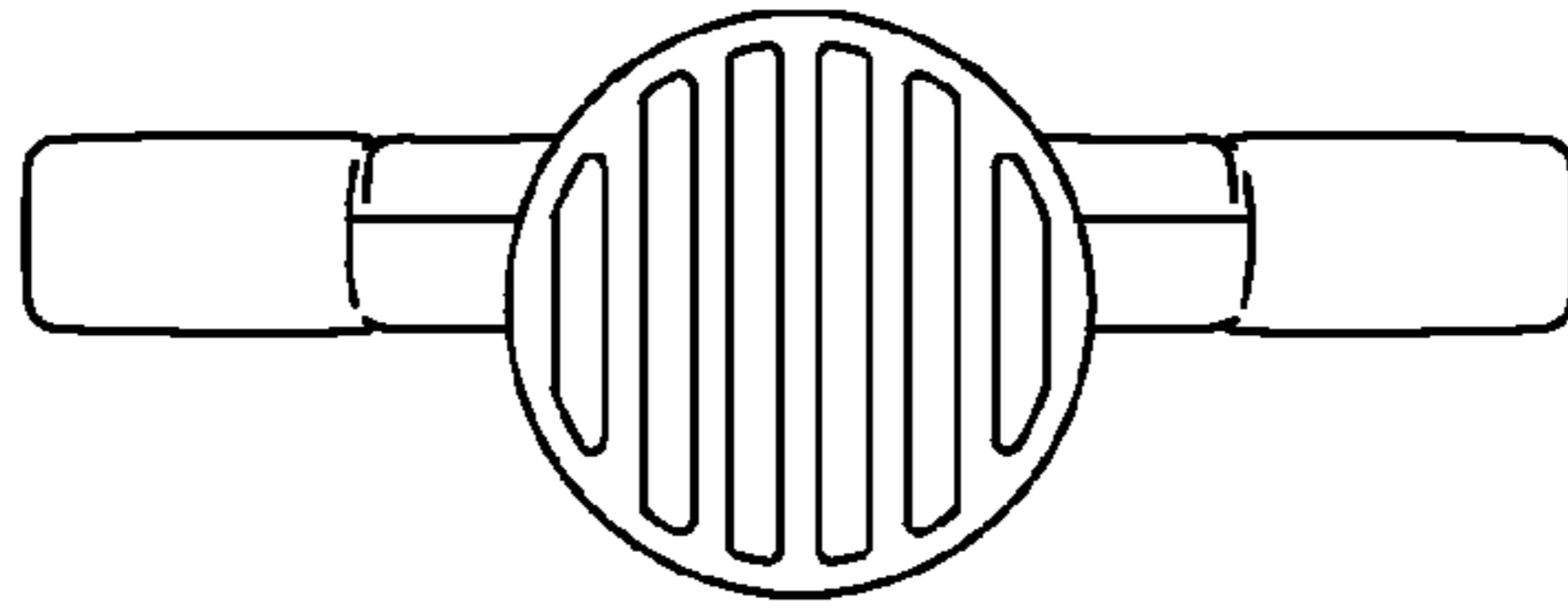

Fig. 5

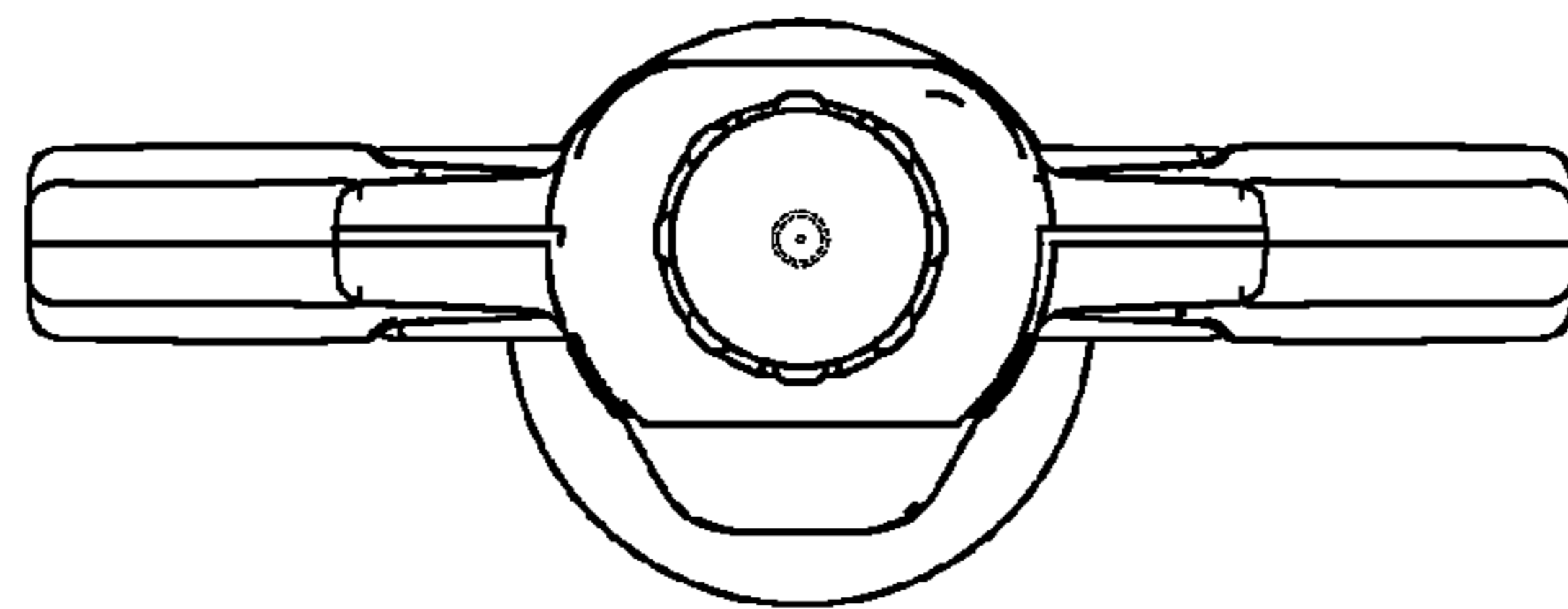

Fig. 6