



US00D735196S

(12) **United States Design Patent**
Son

(10) **Patent No.:** **US D735,196 S**
(45) **Date of Patent:** **** Jul. 28, 2015**

(54) **WIRELESS KEYBOARD**

(71) Applicant: **Samsung Electronics Co., Ltd.**,
Suwon-si, Gyeonggi-do (KR)

(72) Inventor: **Hyunkeun Son**, Seoul (KR)

(73) Assignee: **SAMSUNG ELECTRONICS CO., LTD.** (KR)

(**) Term: **14 Years**

(21) Appl. No.: **29/484,803**

(22) Filed: **Mar. 13, 2014**

(30) **Foreign Application Priority Data**

Sep. 13, 2013 (KR) 30-2013-0047524

(51) **LOC (10) Cl.** **14-02**

(52) **U.S. Cl.**
USPC **D14/392**

(58) **Field of Classification Search**
USPC D14/315-327, 391-399, 455, 456;
D18/1, 2, 7, 11; 235/145 A, 145 R;
341/22, 23; 345/104, 156, 168, 169,
345/173; 361/679.08, 679.09, 679.11,
361/679.26, 679.27; 200/5 A, 5 R, 6 A, 6 R;
400/484-489, 492, 472
CPC G06F 1/16; H01R 35/02; H03M 11/00;
G09B 13/04; H03K 17/94

See application file for complete search history.

(56) **References Cited**

U.S. PATENT DOCUMENTS

6,215,420 B1 *	4/2001	Harrison et al.	341/22
D442,177 S *	5/2001	Chang et al.	D14/392
D643,037 S *	8/2011	Liang	D14/391
D653,665 S *	2/2012	Maruyama	D14/392
D696,667 S *	12/2013	Helwig et al.	D14/392

* cited by examiner

Primary Examiner — Freda S Nunn

(74) *Attorney, Agent, or Firm* — Cantor Colburn LLP

(57) **CLAIM**

I claim, the ornamental design for a wireless keyboard, as shown and described.

DESCRIPTION

FIG. 1 is a top, front perspective view of a wireless keyboard showing my new design;
FIG. 2 is a front elevation view thereof;
FIG. 3 is a rear elevation view thereof;
FIG. 4 is a side elevation view thereof;
FIG. 5 is another side elevation view thereof;
FIG. 6 is a top plan view thereof;
FIG. 7 is a bottom plan view thereof;
FIG. 8 is a top, rear perspective view thereof;
FIG. 9 is a bottom, rear perspective view thereof; and,
FIG. 10 is an enlarged view of the portion A as shown in FIG. 1.

The broken lines are for environmental purpose only and form no part of the claimed design. The dash-dot-dot-dash lines in FIG. 1 are boundary lines showing portion A, and form no part of the claimed design.

1 Claim, 10 Drawing Sheets

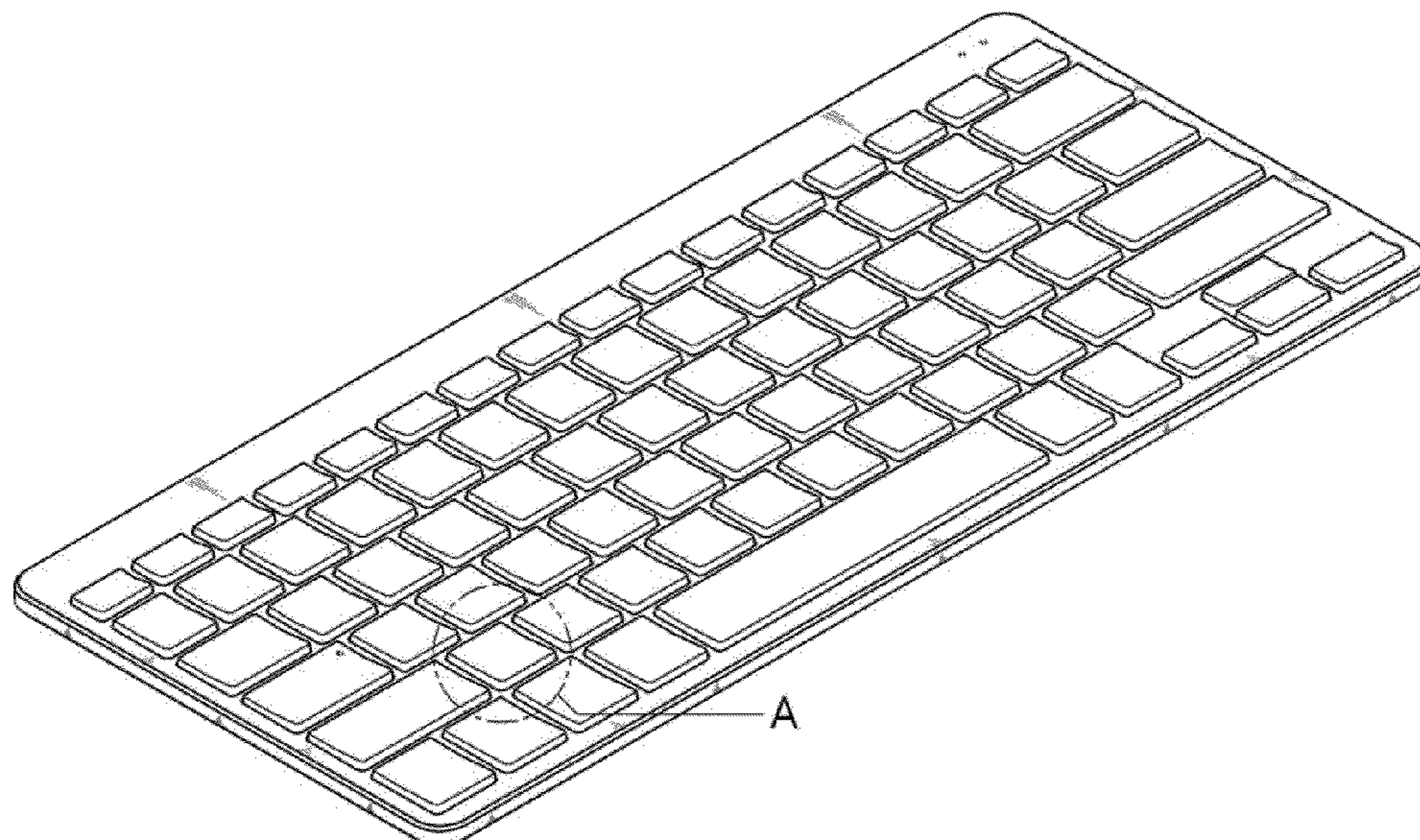

FIG. 1

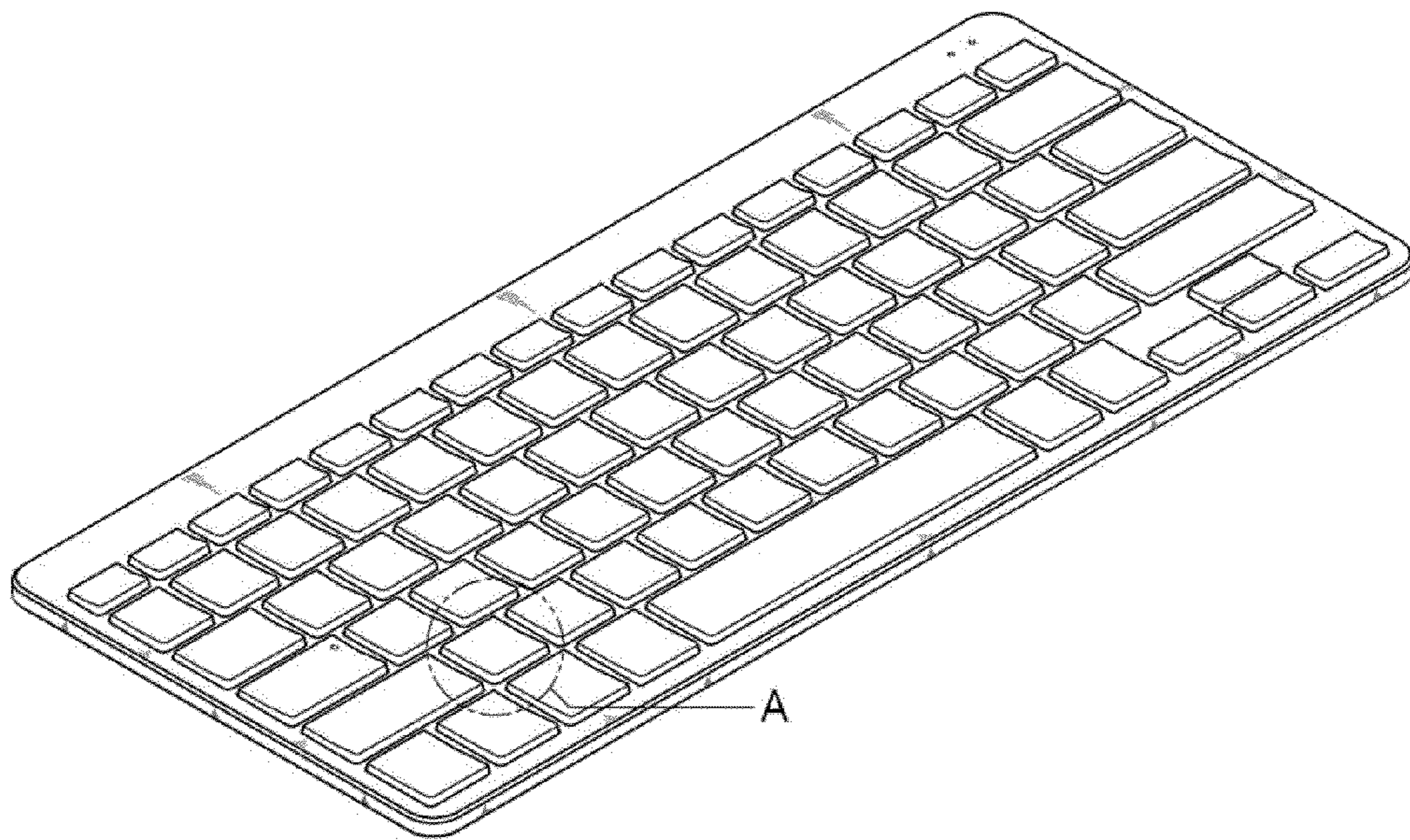

FIG. 2

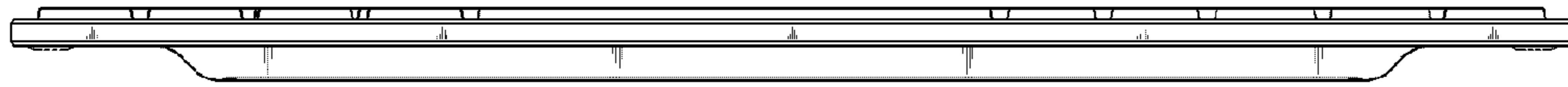

FIG. 3

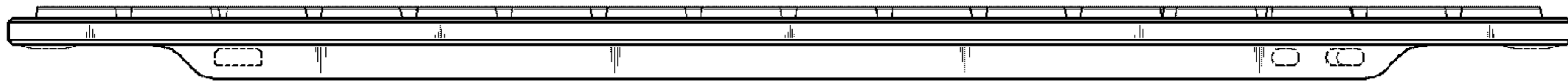

FIG. 4

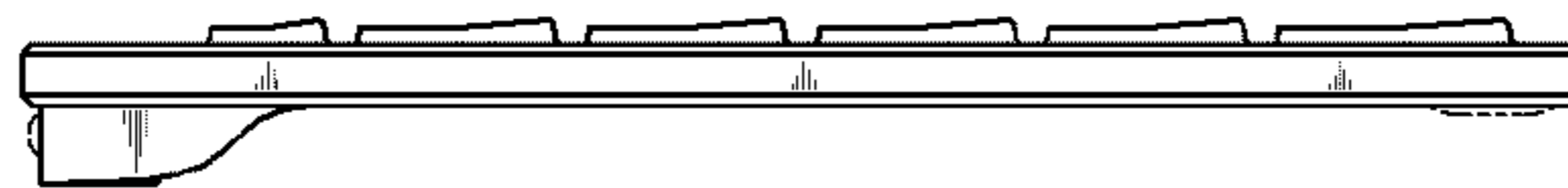

FIG. 5

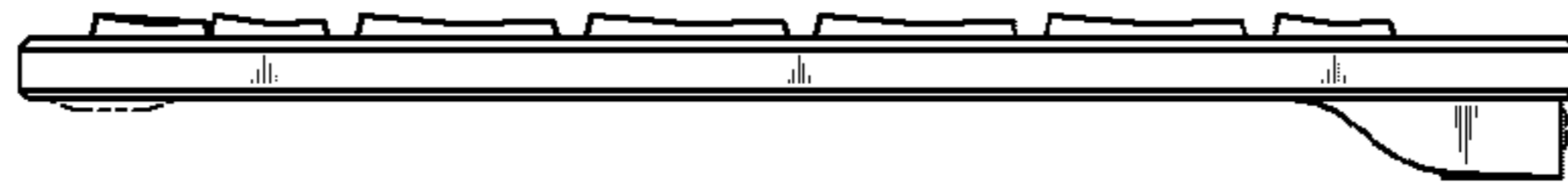

FIG. 6

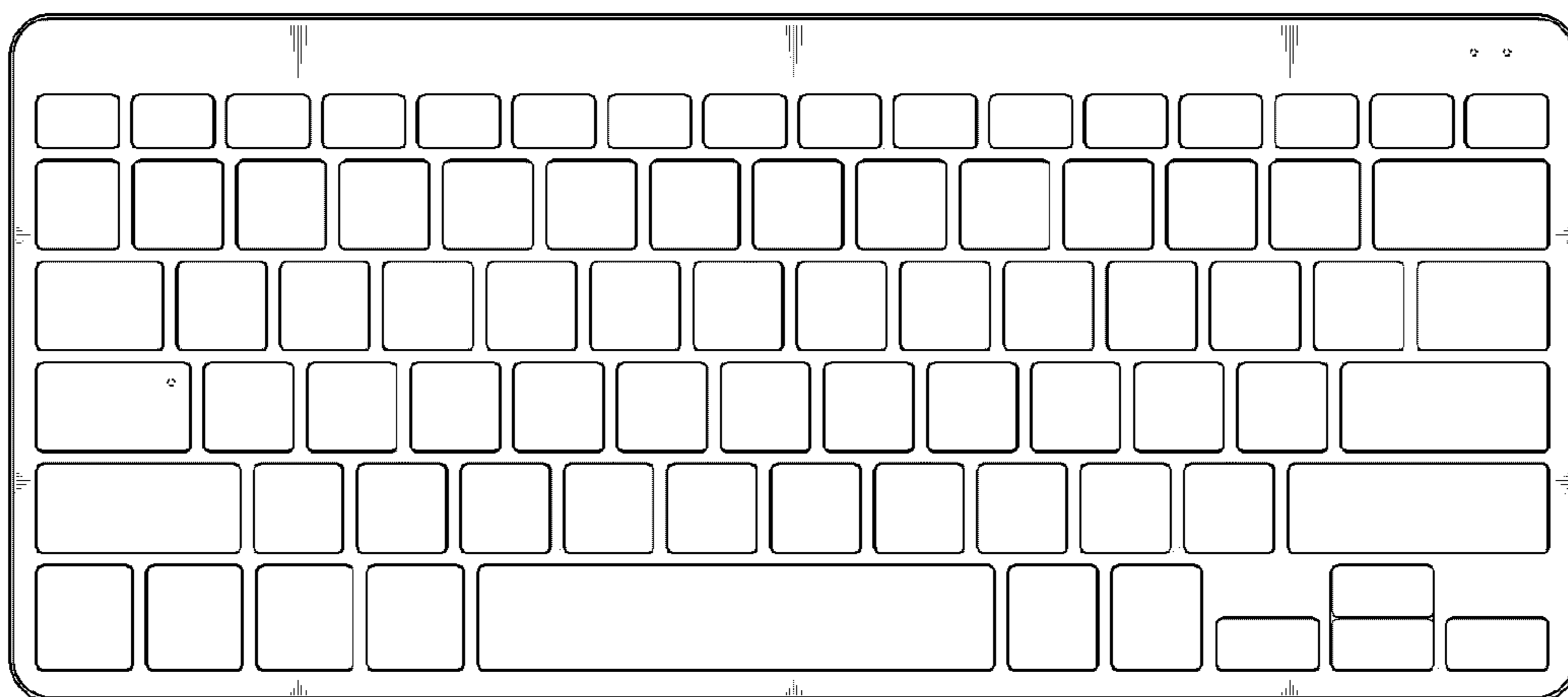

FIG. 7

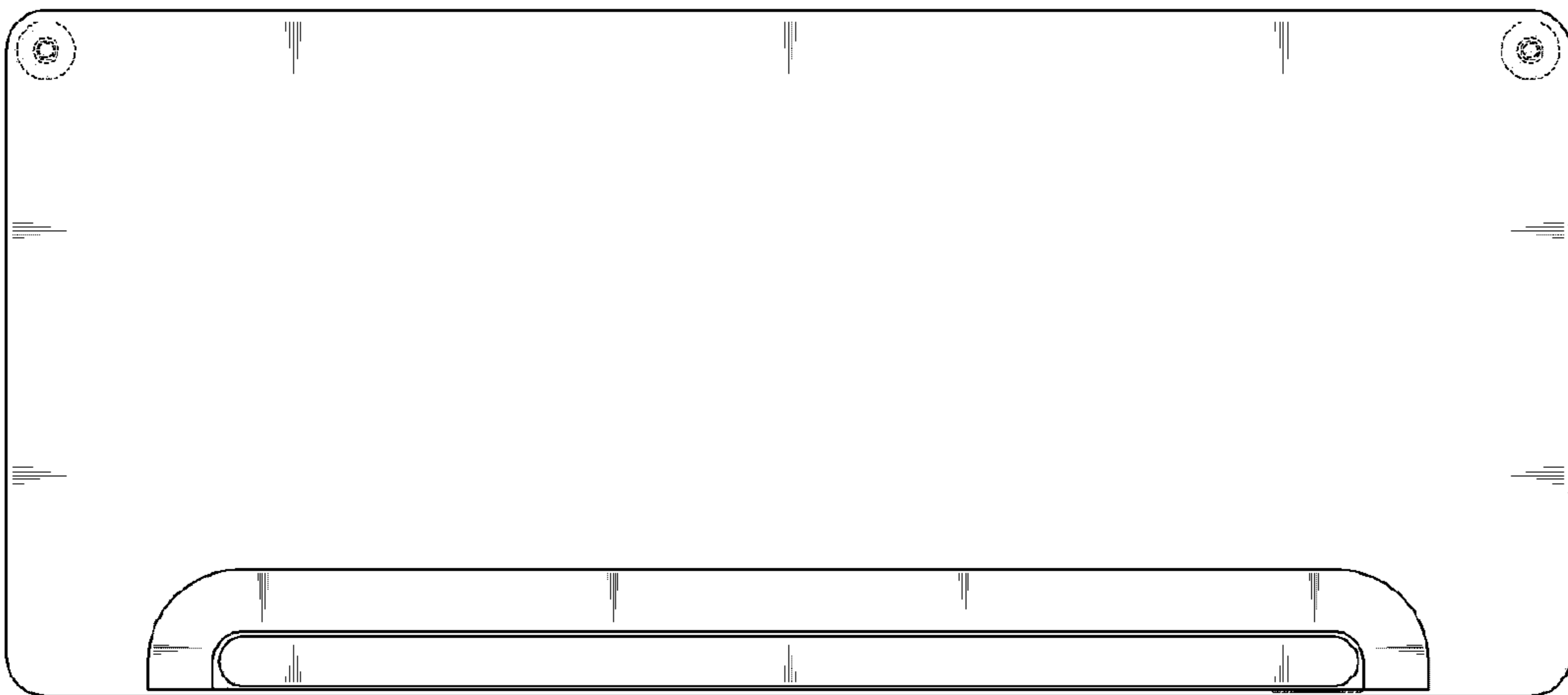

FIG. 8

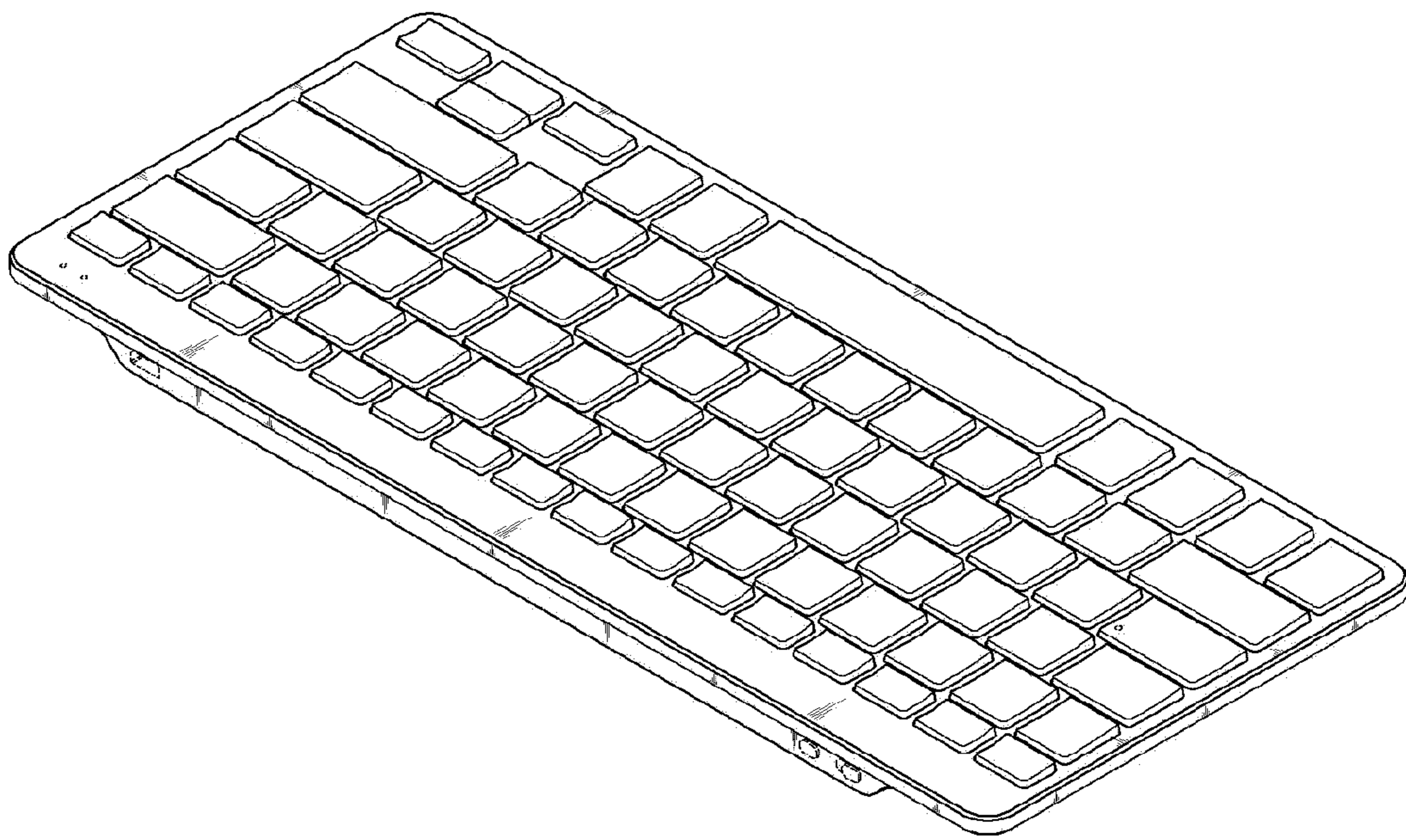

FIG. 9

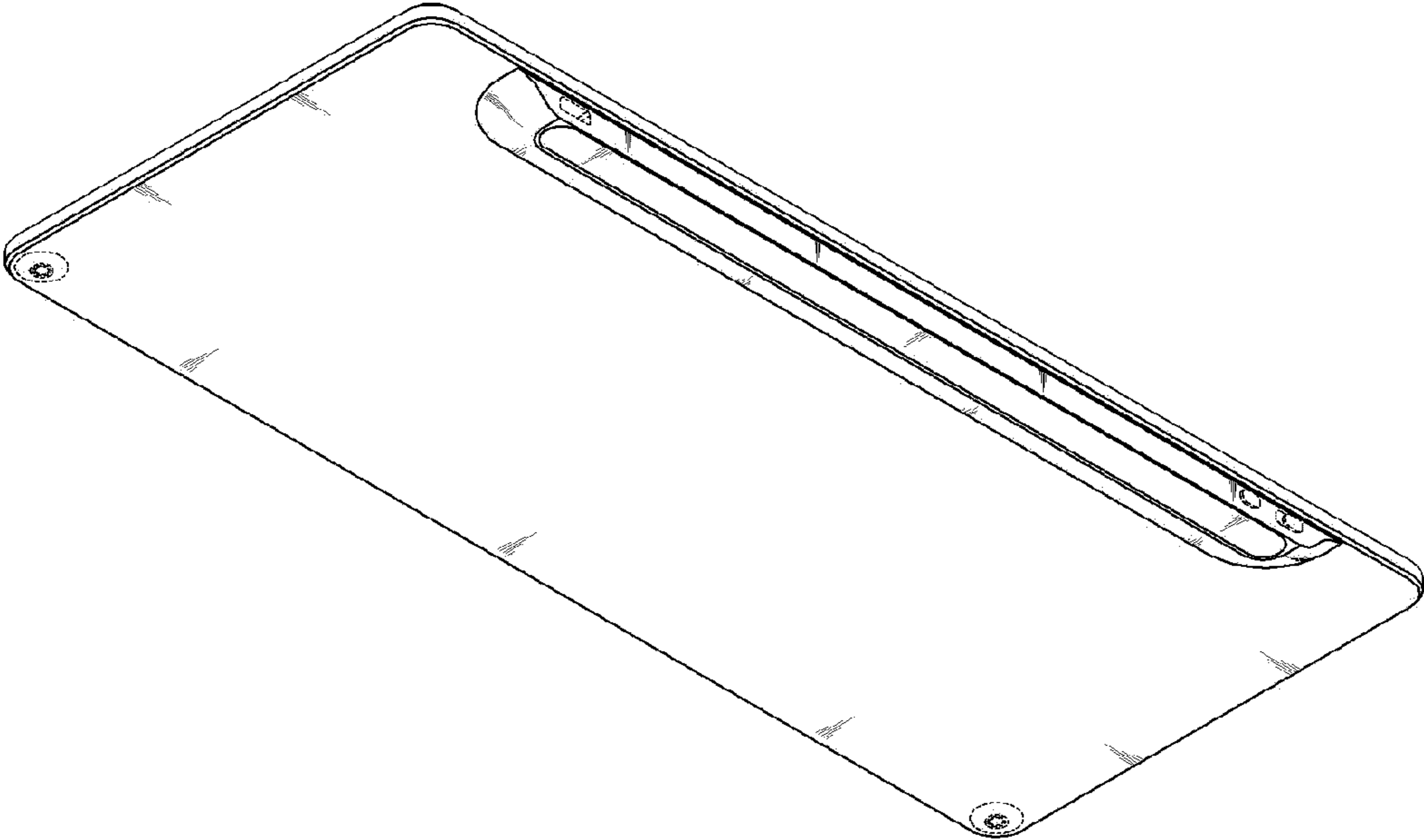

FIG. 10

