



US00D735162S

(12) **United States Design Patent**
Allen

(10) **Patent No.:** **US D735,162 S**
(45) **Date of Patent:** **** Jul. 28, 2015**

(54) **LOUDSPEAKER**

(71) Applicant: **GP ACOUSTICS INTERNATIONAL LIMITED**, Kwai Chung, New Territories (HK)

(72) Inventor: **Graham Allen**, Kwai Chung (HK)

(73) Assignee: **GP ACOUSTICS INTERNATIONAL LIMITED**, Kwai Chung, New Territories (HK)

(**) Term: **14 Years**

(21) Appl. No.: **29/450,705**

(22) Filed: **Mar. 21, 2013**

(51) **LOC (10) Cl.** **14-03**

(52) **U.S. Cl.**
USPC **D14/216; D14/211**

(58) **Field of Classification Search**
USPC D14/167, 168, 170-172, 188, 192, D14/194-196, 204, 207, 209.1, 210-216, D14/219, 221, 222, 224, 496; 181/143, 144, 181/147, 148, 150, 153, 157, 198, 199; 381/300-303, 306, 332, 333, 336, 345, 381/361-364, 386, 388; 369/6-12

See application file for complete search history.

(56) **References Cited**

U.S. PATENT DOCUMENTS

D395,432 S *	6/1998	Woolley et al.	D14/168
D457,153 S *	5/2002	Allen	D14/168
D547,746 S *	7/2007	Allen	D14/211
D571,786 S *	6/2008	Cho	D14/215
D595,705 S *	7/2009	Houdek, II	D14/240
D636,372 S *	4/2011	Leung	D14/168
D714,765 S *	10/2014	Goransson	D14/223

* cited by examiner

Primary Examiner — Keli L Hill

(74) *Attorney, Agent, or Firm* — Nixon Peabody LLP; Jeffrey L. Costellia

(57) **CLAIM**

The ornamental design for a loudspeaker, as shown and described.

DESCRIPTION

FIG. 1 is a front elevational view of a loudspeaker showing my new design;
FIG. 2 is a rear elevational view thereof;
FIG. 3 is a right side elevational view thereof;
FIG. 4 is a left side elevational view thereof;
FIG. 5 is a top plan view thereof;
FIG. 6 is a bottom plan view thereof;
FIG. 7 is a front perspective view thereof; and,
FIG. 8 is a rear perspective view thereof.
The broken lines shown in the drawings represent unclaimed portions of the loudspeaker and form no part of the claimed invention.

1 Claim, 8 Drawing Sheets

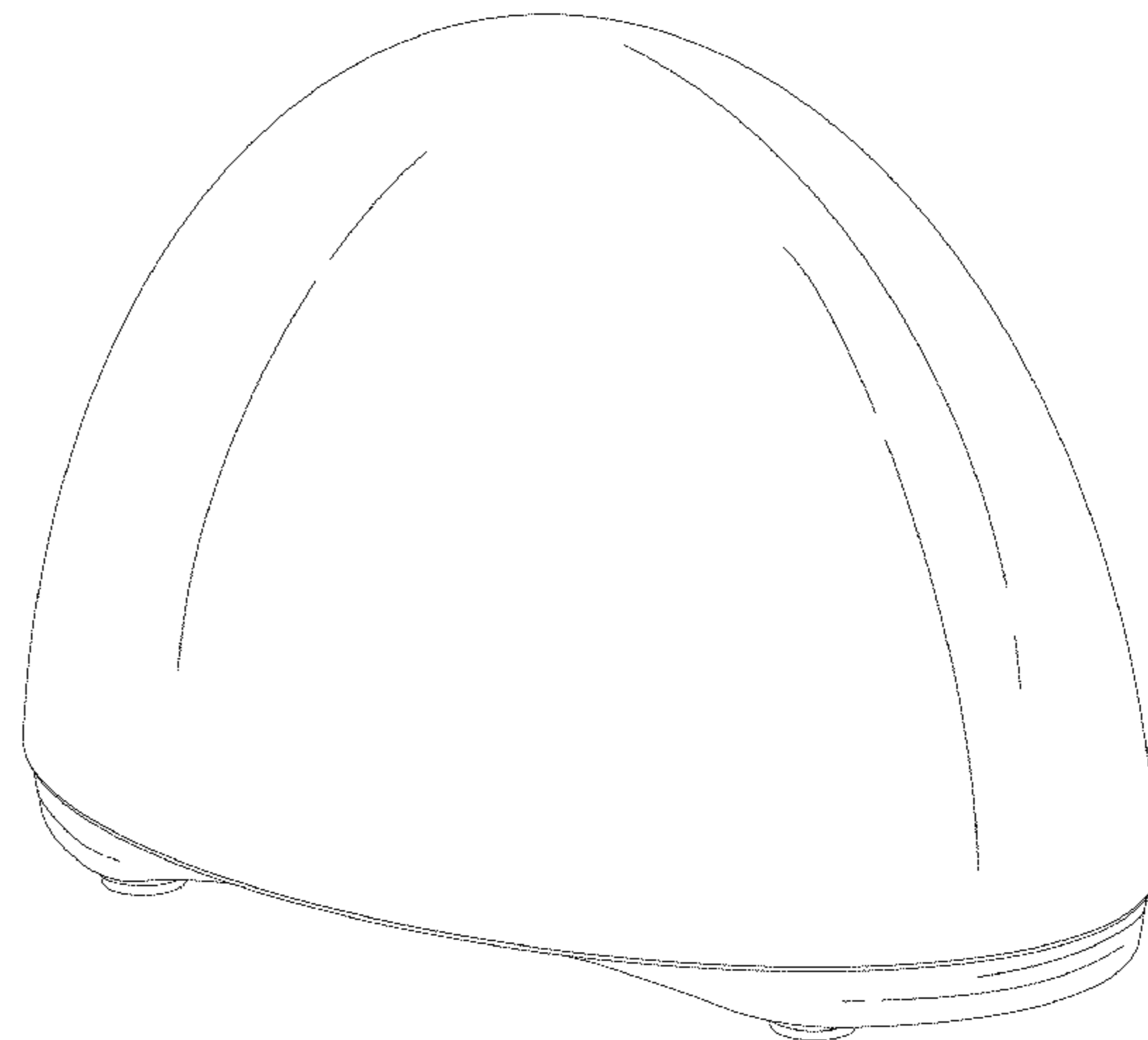
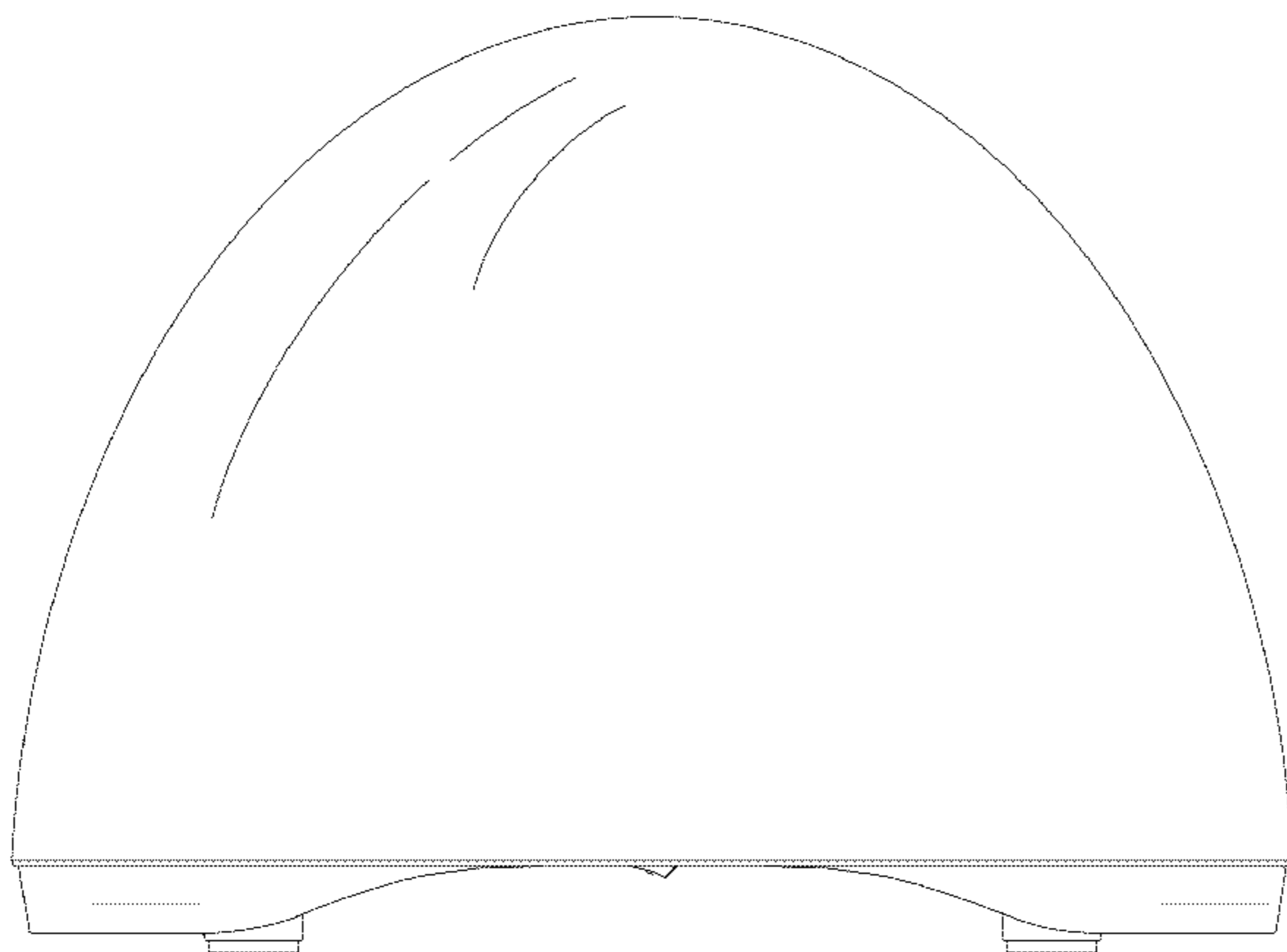

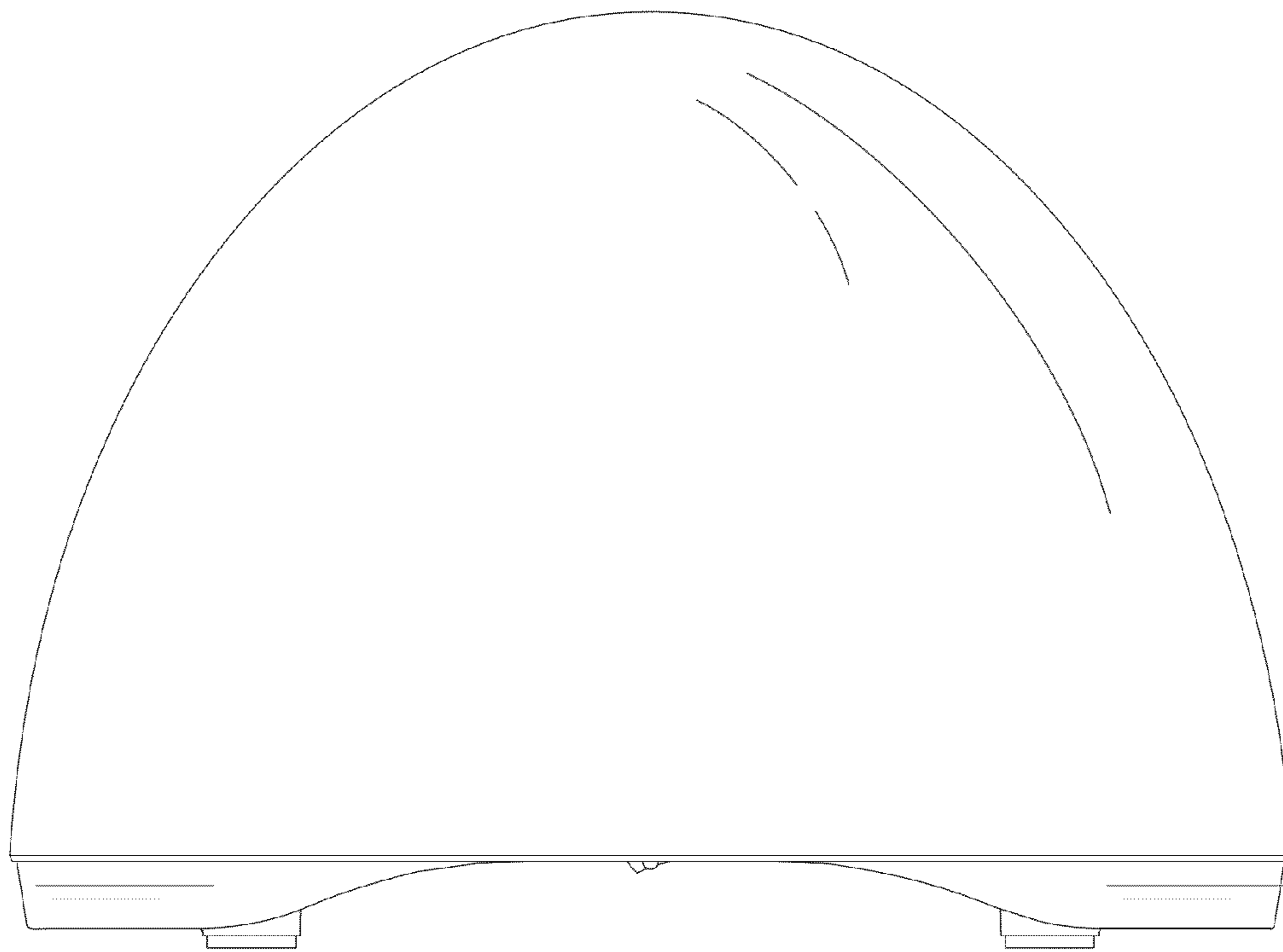

FIG. 1

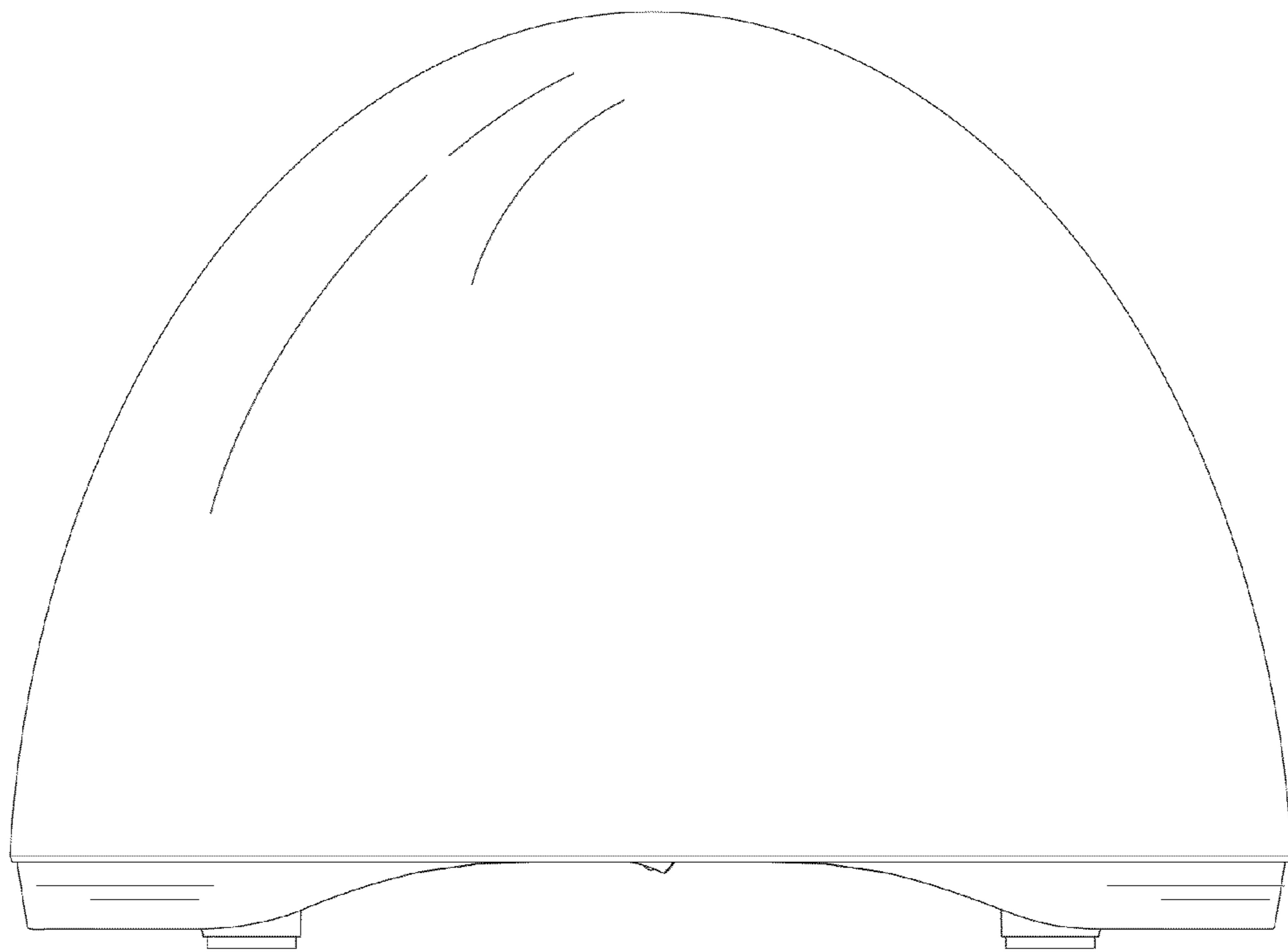

FIG. 2

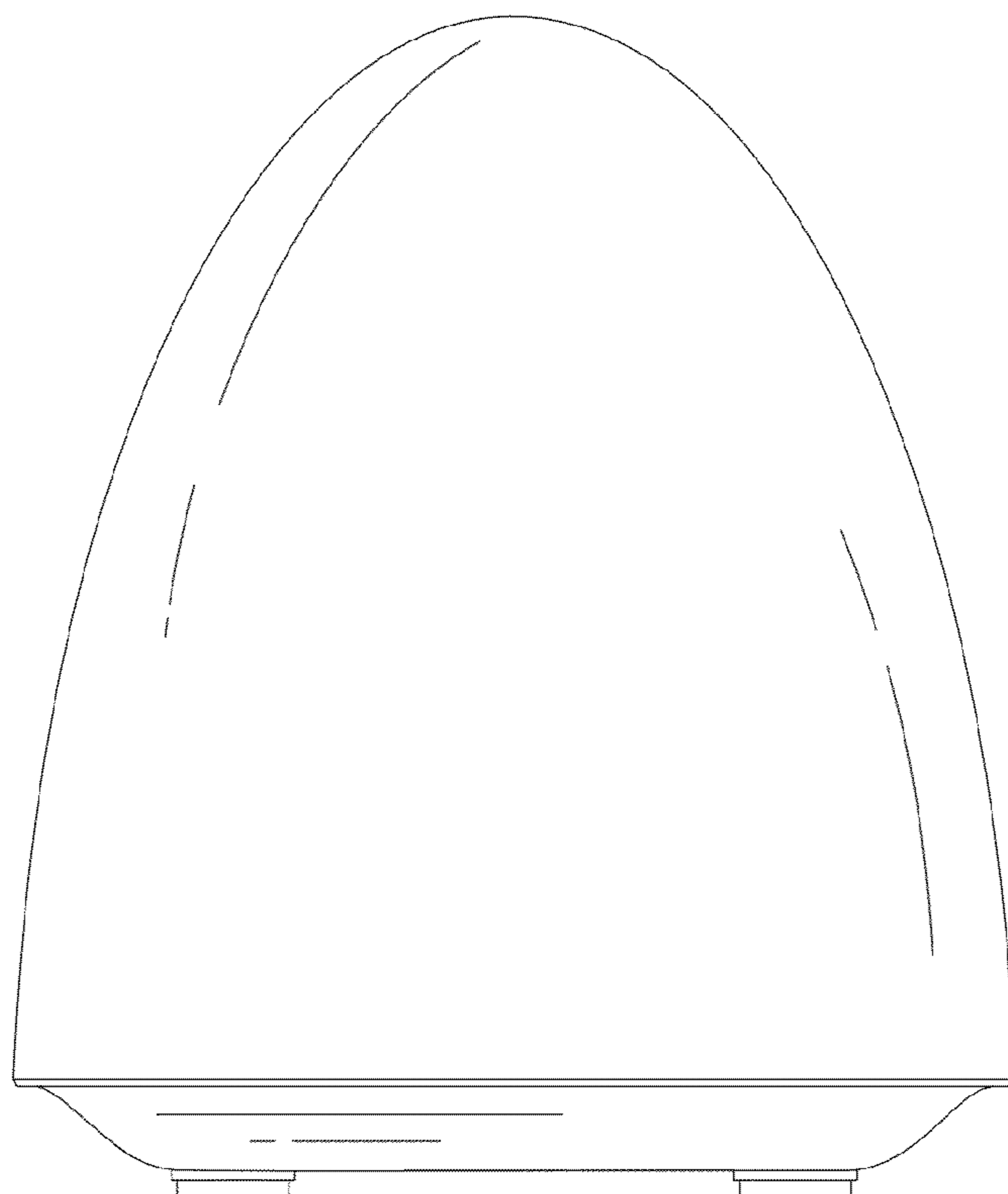

FIG. 3

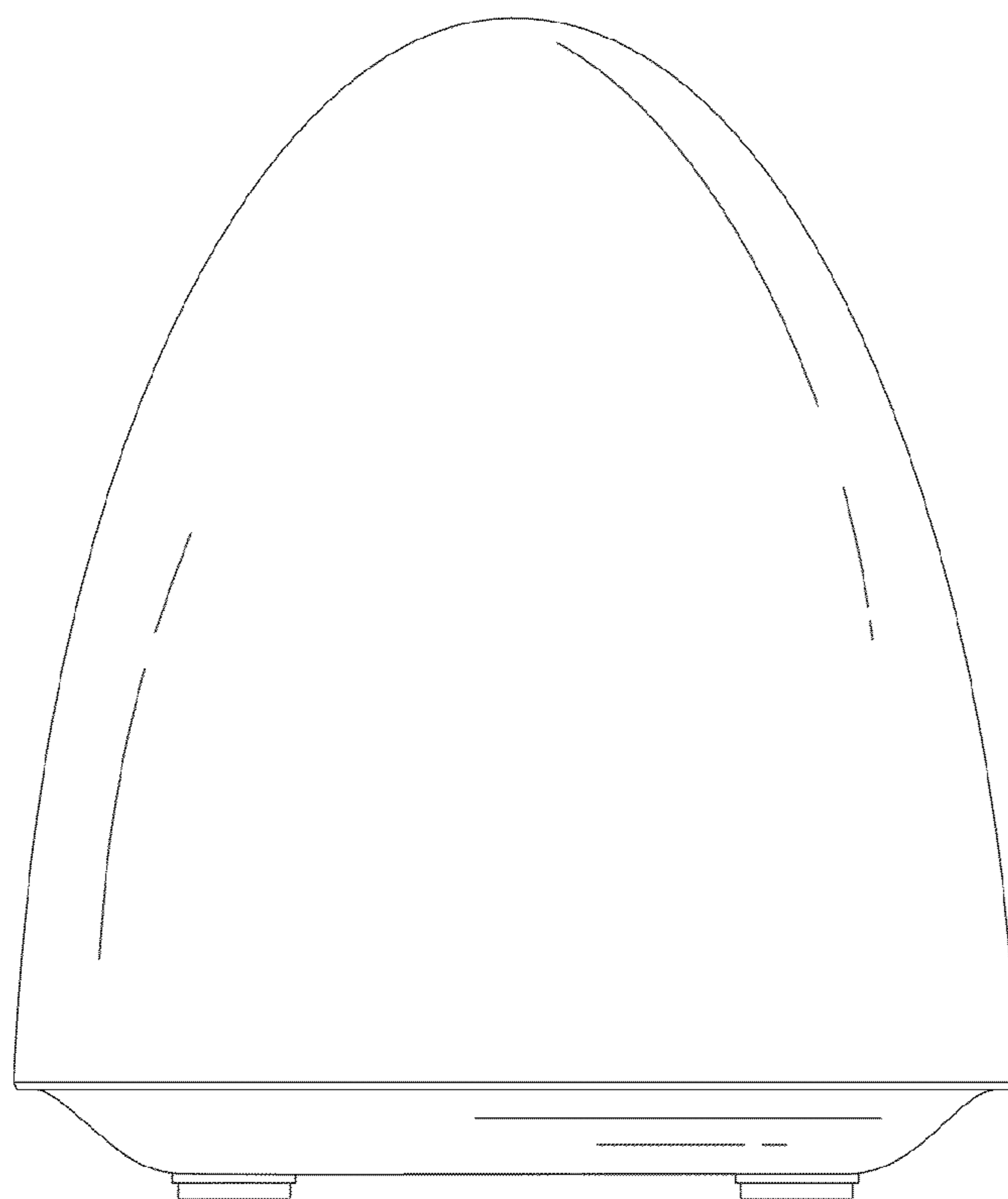

FIG. 4

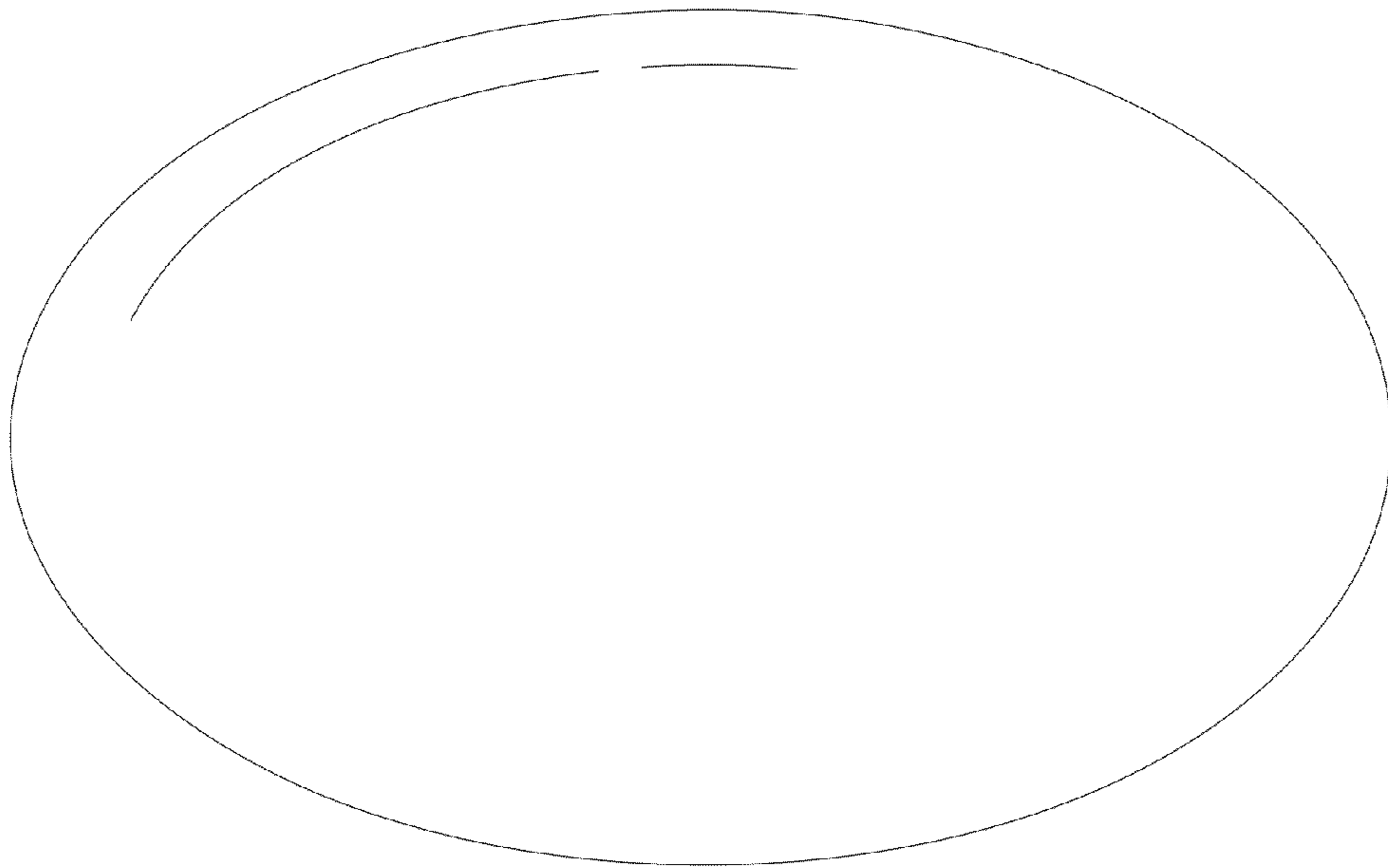

FIG. 5

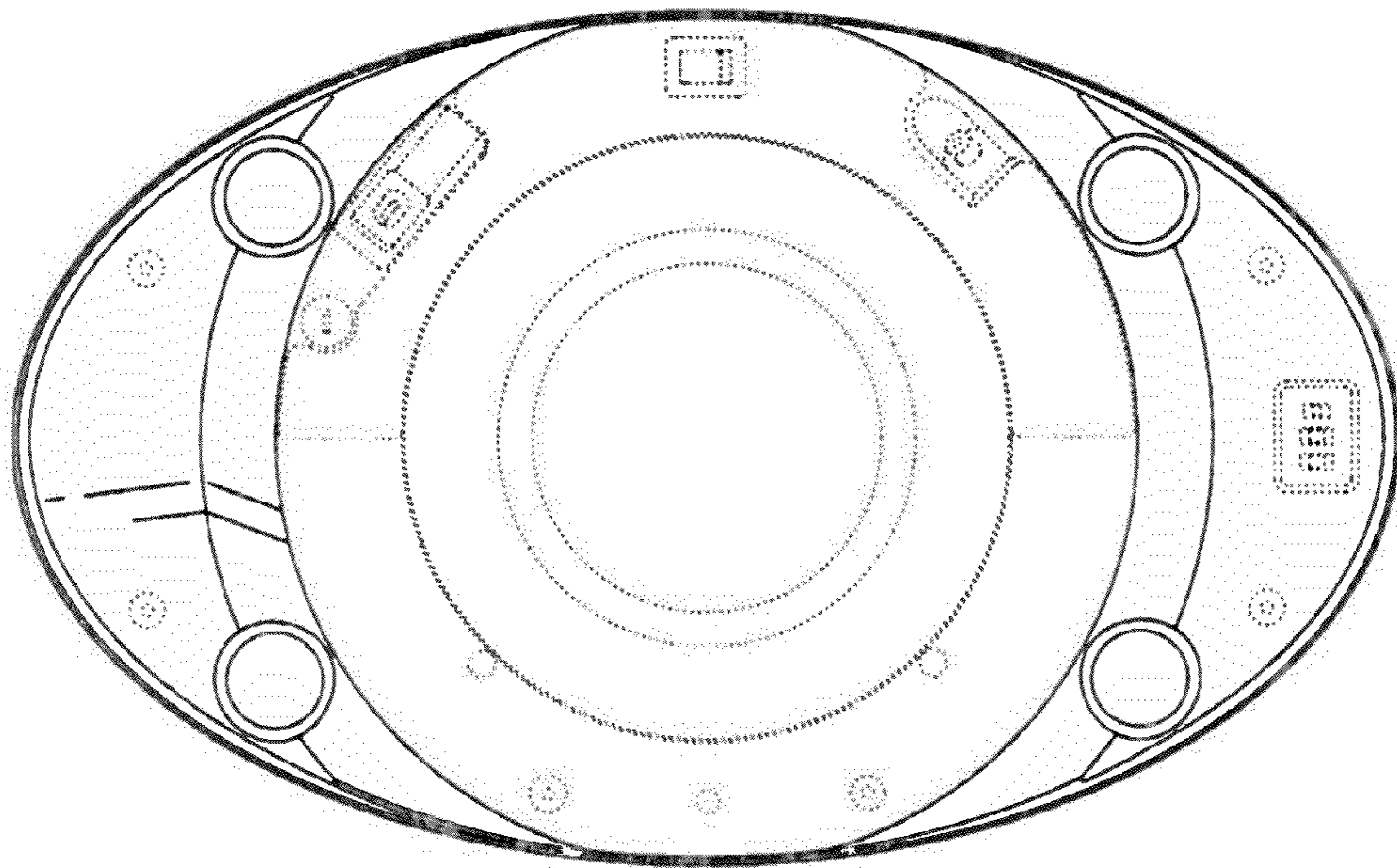

FIG. 6



FIG. 7



FIG. 8