



US00D735141S

(12) **United States Design Patent**
Fries

(10) **Patent No.:** **US D735,141 S**
(45) **Date of Patent:** **** Jul. 28, 2015**

(54) **SENSOR CONNECTOR**

FOREIGN PATENT DOCUMENTS

- (71) Applicant: **Covidien LP**, Mansfield, MA (US)
- (72) Inventor: **Timothy W. Fries**, Louisville, CO (US)
- (73) Assignee: **Covidien LP**, Mansfield, MA (US)
- (**) Term: **14 Years**
- (21) Appl. No.: **29/488,945**

EP	1945099	A1	4/2007
JP	2005052385	A2	3/2005
JP	2005110816	A2	4/2005
JP	2006061566	A2	3/2006
JP	2007117641	A	5/2007
JP	2007167183	A	7/2007
JP	2007167184	A	7/2007
JP	2007190122	A	8/2007

* cited by examiner

- (22) Filed: **Apr. 24, 2014**
- (51) **LOC (10) Cl.** **13-03**
- (52) **U.S. Cl.**
USPC **D13/147**
- (58) **Field of Classification Search**
USPC D13/147, 154, 184, 199
See application file for complete search history.

Primary Examiner — Daniel Bui
(74) *Attorney, Agent, or Firm* — Fletcher Yoder PC

(57) **CLAIM**

I claim the ornamental design for a sensor connector, as shown and described.

DESCRIPTION

(56) **References Cited**

U.S. PATENT DOCUMENTS

D329,042	S	*	9/1992	van der Burgh	D13/133
5,851,178	A		12/1998	Aronow		
D424,020	S	*	5/2000	Fischer	D13/146
D443,859	S	*	6/2001	Hogan	D13/133
D473,849	S	*	4/2003	Yeh	D13/147
6,541,756	B2		4/2003	Schulz et al.		
D584,648	S	*	1/2009	Sekiguchi et al.	D10/78
D615,040	S	*	5/2010	Slippy et al.	D13/133
D625,211	S	*	10/2010	Chun	D10/78
D713,751	S	*	9/2014	Nadeau	D10/78
2002/0103423	A1		8/2002	Chin et al.		
2008/0076980	A1		3/2008	Hoarau		
2008/0076995	A1		3/2008	Hoarau		
2008/0076996	A1		3/2008	Hoarau		

FIG. 1 is a perspective view of the sensor connector of the present invention with a movable cover in the open position; FIG. 2 is a perspective view of the sensor connector of FIG. 1 with the movable cover in an alternate closed position; FIG. 3 is a top view of the sensor connector of FIG. 2; FIG. 4 is a bottom view of the sensor connector of FIG. 2; FIG. 5 is a right side view of the sensor connector of FIG. 2; FIG. 6 is a left side view of the sensor connector of FIG. 2; FIG. 7 is a front view of the sensor connector of FIG. 2; and, FIG. 8 is a rear view of the sensor connector of FIG. 2. Any subject matter shown in broken lines in the drawings constitutes the environment only and forms no part of the protection sought.

1 Claim, 4 Drawing Sheets

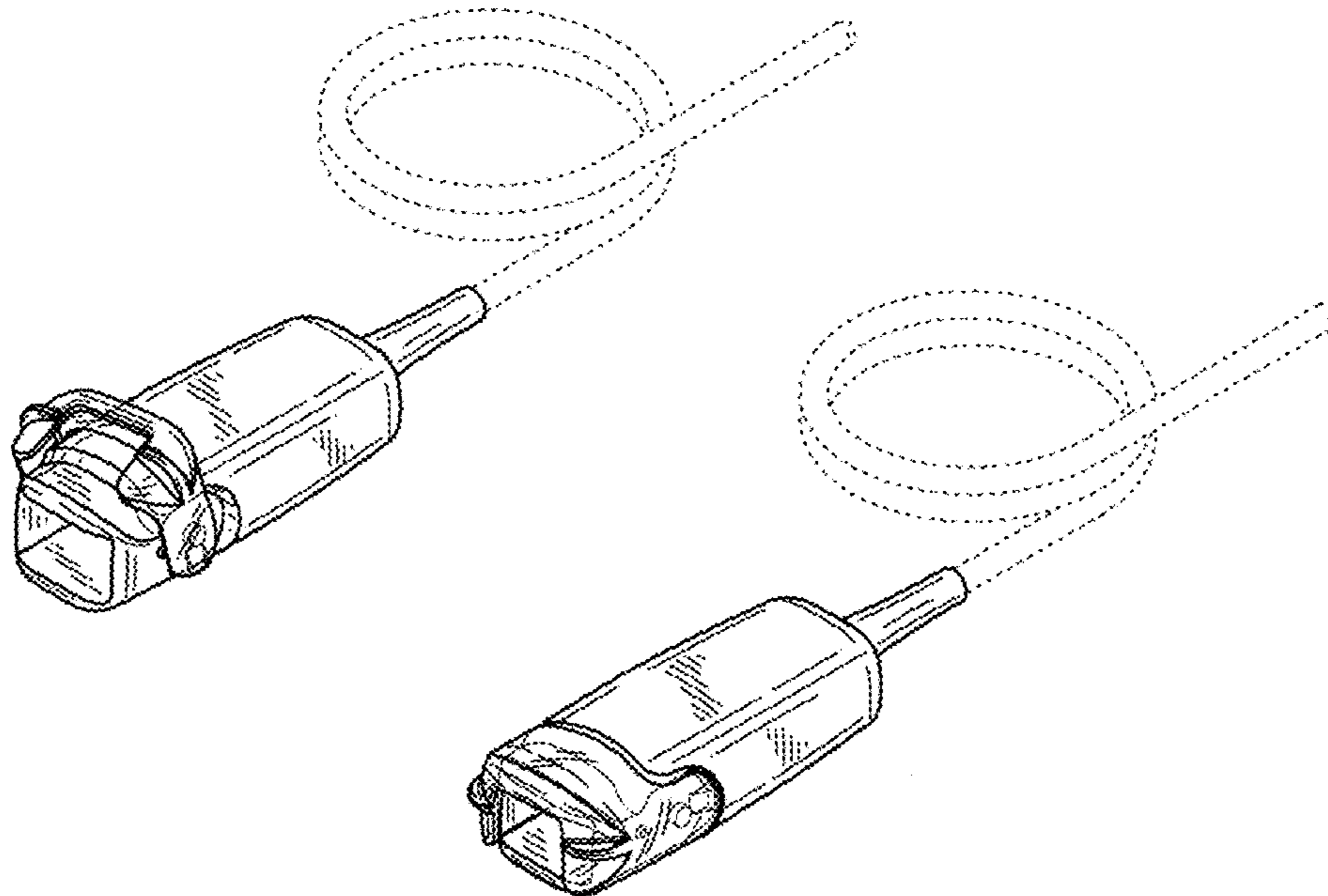

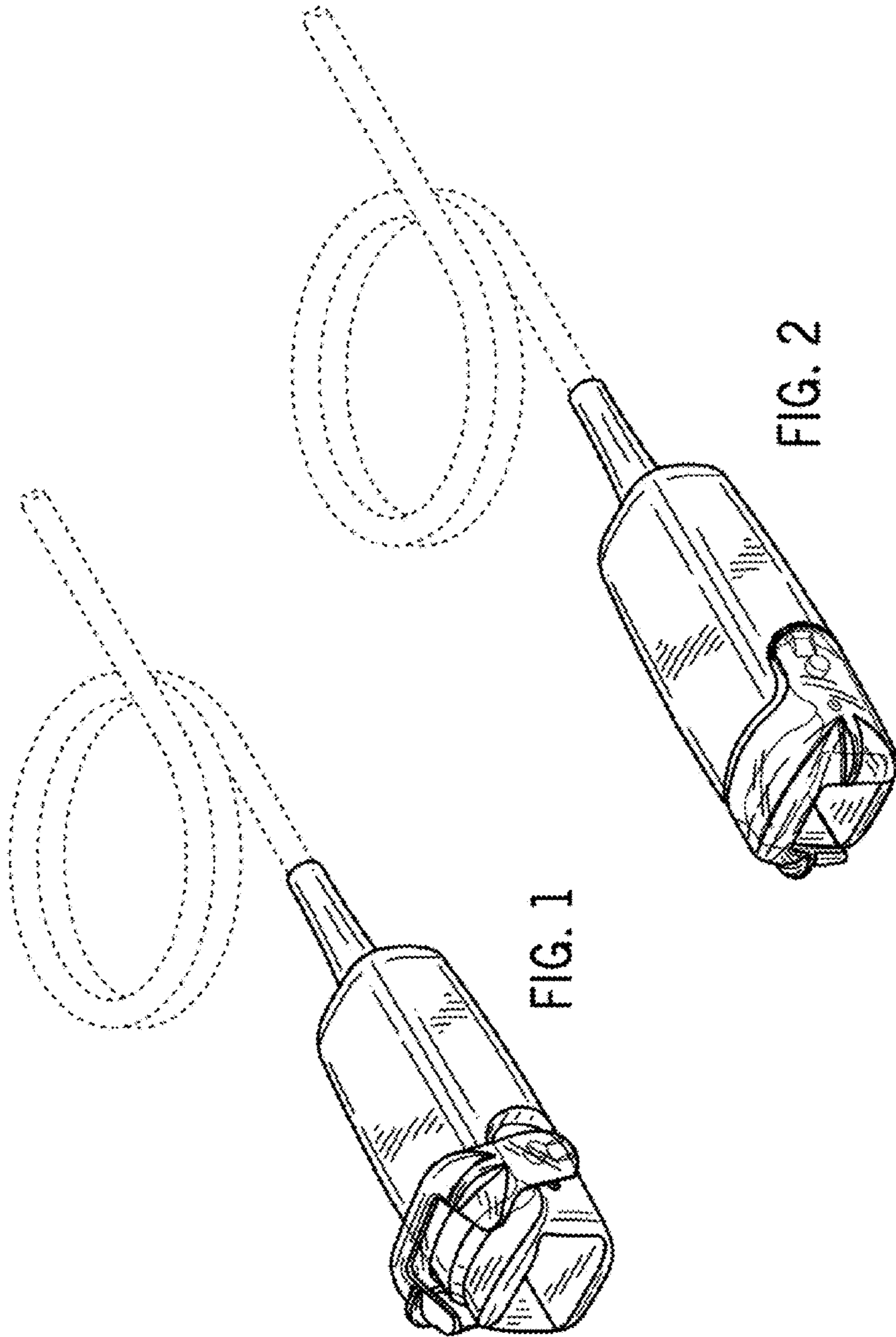

FIG. 1

FIG. 2

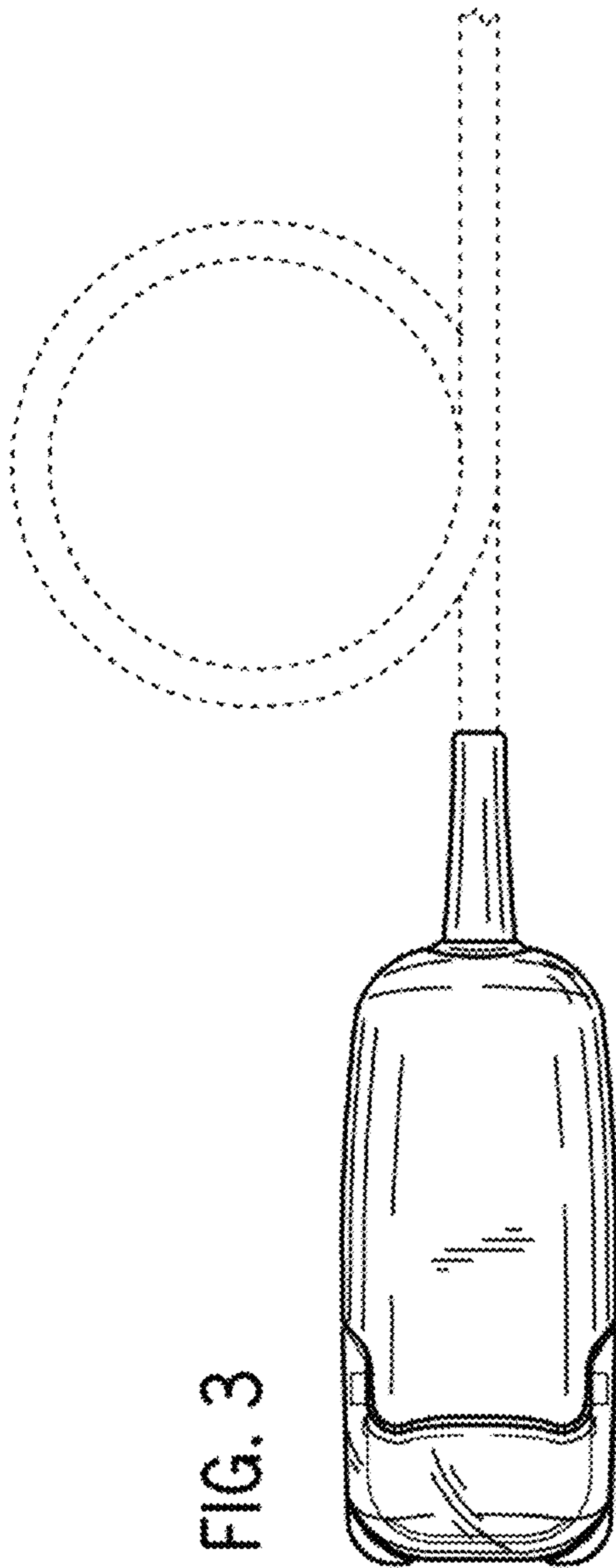

FIG. 3

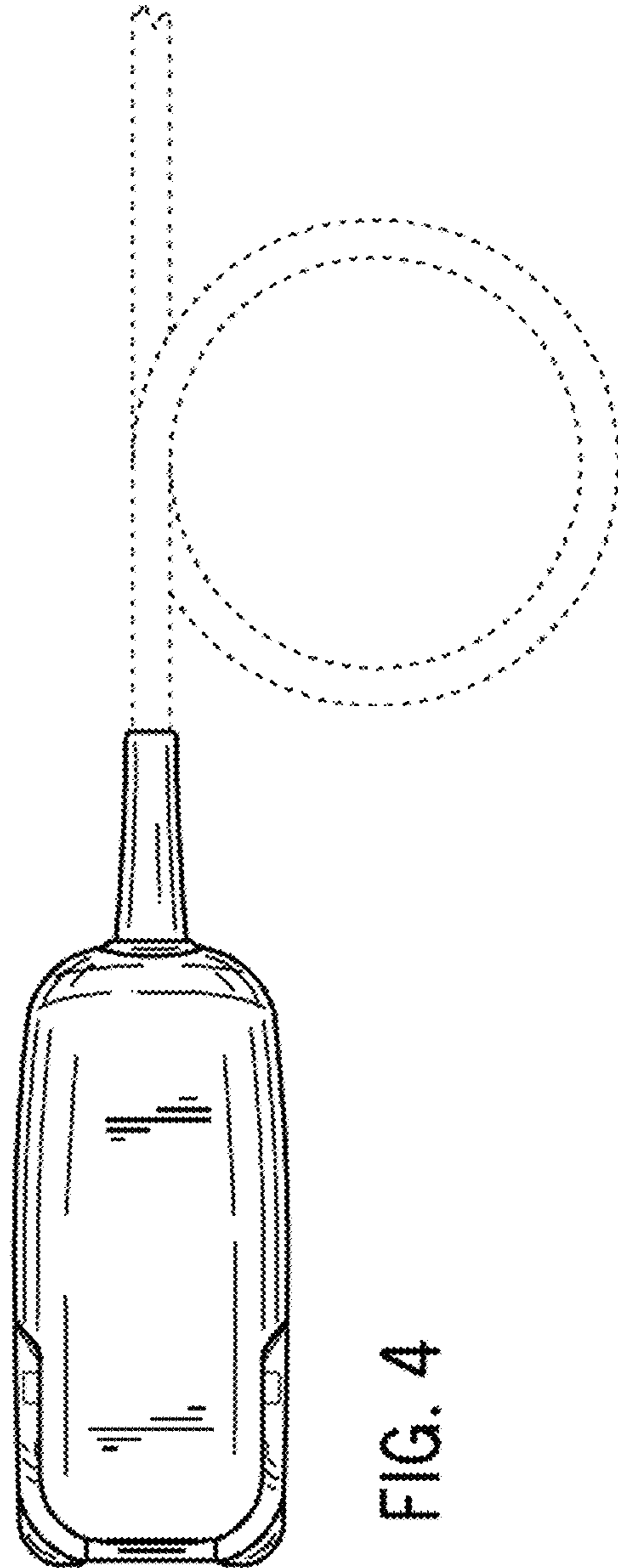

FIG. 4

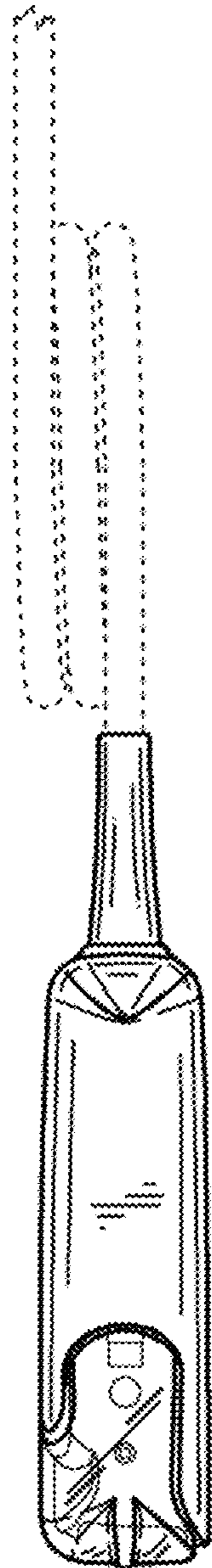

FIG. 5

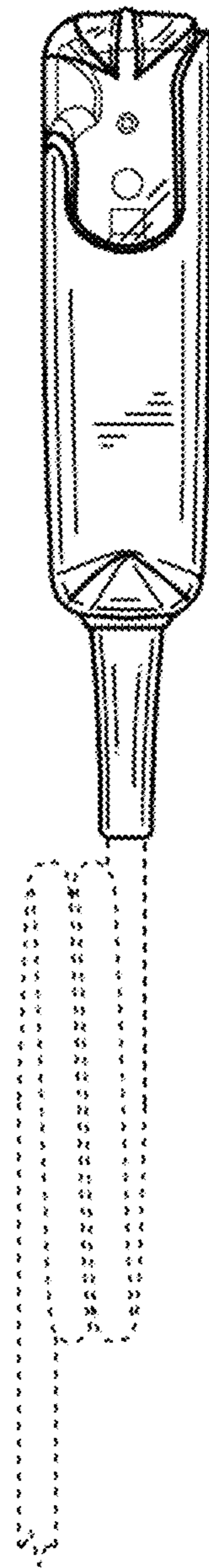

FIG. 6

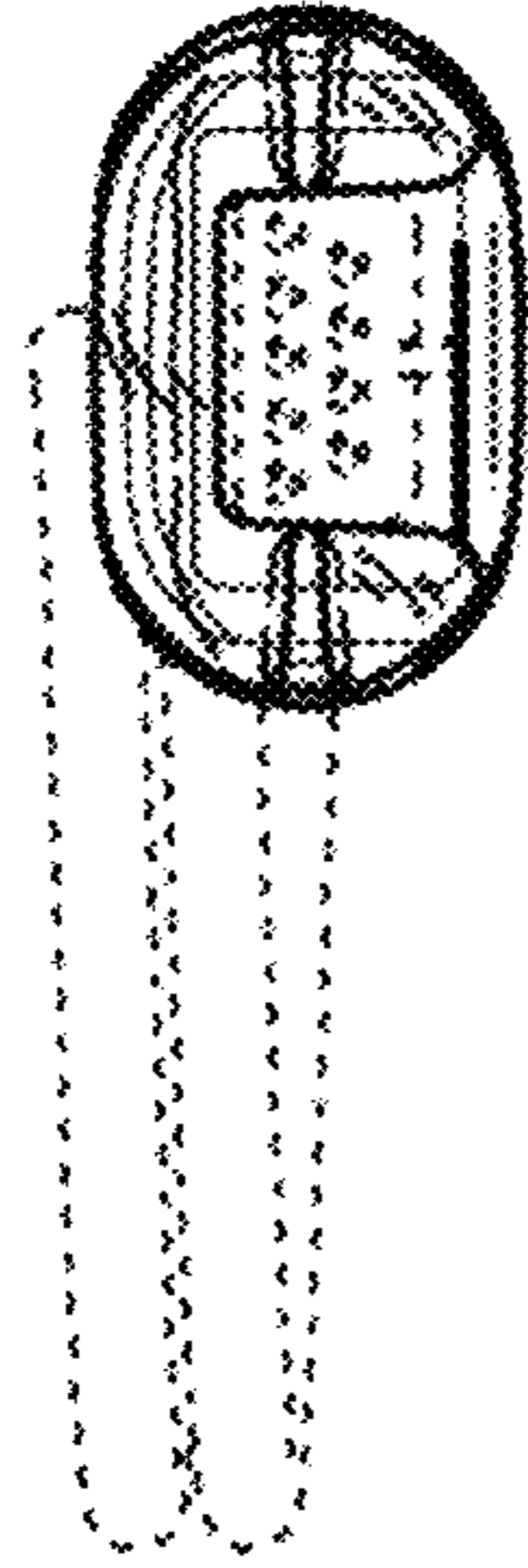

FIG. 7

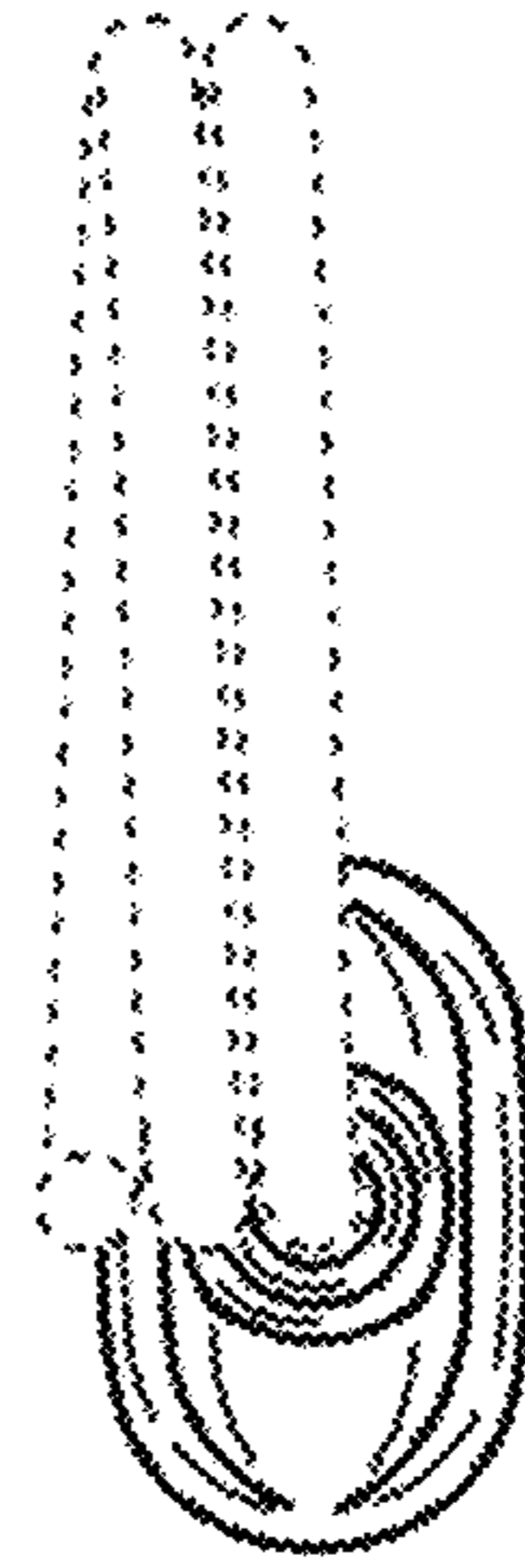

FIG. 8