



US00D735129S

(12) **United States Design Patent**  
**Esses**

(10) **Patent No.:** **US D735,129 S**  
(45) **Date of Patent:** **\*\* Jul. 28, 2015**

- (54) **MOUNTED CHARGER**
- (71) Applicant: **PREMIER ACCESSORY GROUP LLC**, Edison, NJ (US)
- (72) Inventor: **Alfred Esses**, Brooklyn, NY (US)
- (73) Assignee: **Premier Accessory Group LLC**, Edison, NJ (US)
- (\*\*) Term: **14 Years**
- (21) Appl. No.: **29/479,876**
- (22) Filed: **Jan. 21, 2014**
- (51) **LOC (10) Cl.** ..... **13-02**
- (52) **U.S. Cl.**  
USPC ..... **D13/108**
- (58) **Field of Classification Search**  
USPC ..... D13/107-110, 118-119, 184, 199;  
D14/251, 253, 432, 434  
CPC ..... H02J 7/025; H02J 7/0042; H02J 7/0044;  
H02J 7/0045; H02J 7/0054; H02J 7/003;  
B60L 11/182; Y02E 60/12; Y02T 10/7005;  
Y02T 10/7088; Y02T 90/14; Y02T 90/163;  
Y02T 90/122; Y02T 90/128; H01M 2/1022;  
H01M 2/1055; H01M 10/46; H01M 10/44;  
H01M 10/425; H01F 38/14; H01R 13/6675  
See application file for complete search history.

- (56) **References Cited**  
U.S. PATENT DOCUMENTS  
D278,508 S \* 4/1985 Kafka ..... D7/386  
D433,992 S \* 11/2000 Luecke ..... D13/108  
D435,242 S \* 12/2000 Yoshida ..... D13/110  
D438,536 S \* 3/2001 Willison et al. .... D14/253  
D464,934 S \* 10/2002 Chen ..... D13/110

D511,746 S *	11/2005	Lu	.....	D13/110
D512,020 S *	11/2005	Wang	.....	D13/110
D533,500 S *	12/2006	Wang	.....	D13/110
D598,374 S *	8/2009	Sasada	.....	D13/108
D652,795 S *	1/2012	Attanasio	.....	D13/118
8,142,228 B1 *	3/2012	Wu	.....	439/628
D665,346 S *	8/2012	Kumagai et al.	.....	D13/108
D670,244 S *	11/2012	Workman et al.	.....	D13/110
D678,193 S *	3/2013	Siminoff et al.	.....	D13/108
D683,311 S *	5/2013	Siminoff et al.	.....	D13/108
D685,735 S *	7/2013	Wang	.....	D13/110
D685,736 S *	7/2013	Inskeep	.....	D13/110
D704,636 S *	5/2014	Huang	.....	D13/108
2012/0276782 A1 *	11/2012	Stack et al.	.....	439/660
2013/0063077 A1 *	3/2013	Popper et al.	.....	320/107

\* cited by examiner

*Primary Examiner* — Rosemary K Tarcza  
(74) *Attorney, Agent, or Firm* — Gottlieb, Rackman & Reisman, P.C.

(57) **CLAIM**  
The ornamental design for a mounted charger, as shown and described.

**DESCRIPTION**  
FIG. 1 is a front, top, left side perspective view of a mounted charger having the design of my invention;  
FIG. 2 is top plan view thereof;  
FIG. 3 is a front elevation view thereof;  
FIG. 4 is a side view thereof, where the right and left sides of the design are mirror images of each other;  
FIG. 5 is a rear elevation view thereof;  
FIG. 6 is a bottom plan view thereof; and,  
FIG. 7 is a rear, top, right side perspective view thereof.  
It being understood that the broken lines are for illustrative purposes only and form no part of the claimed design.

**1 Claim, 4 Drawing Sheets**

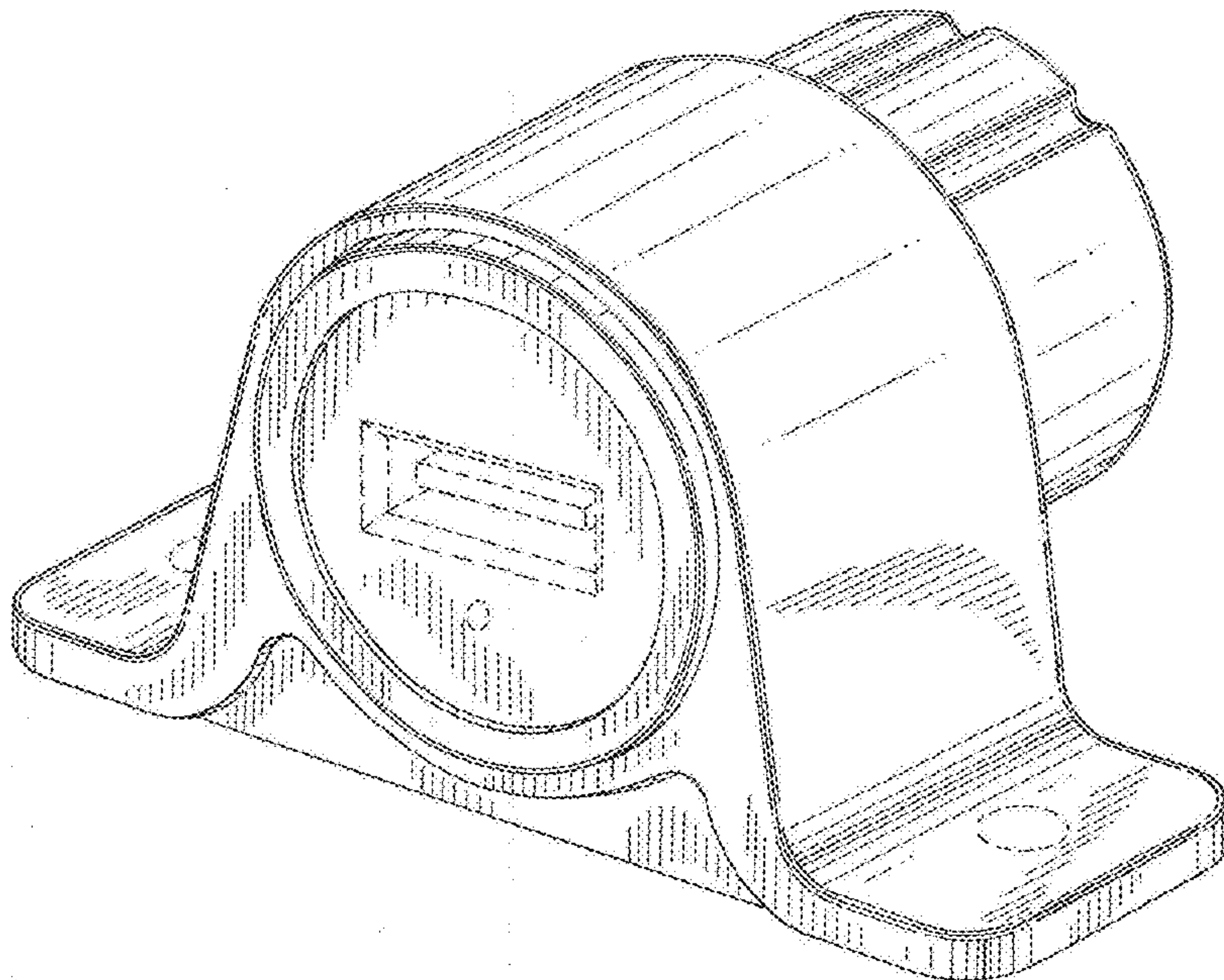

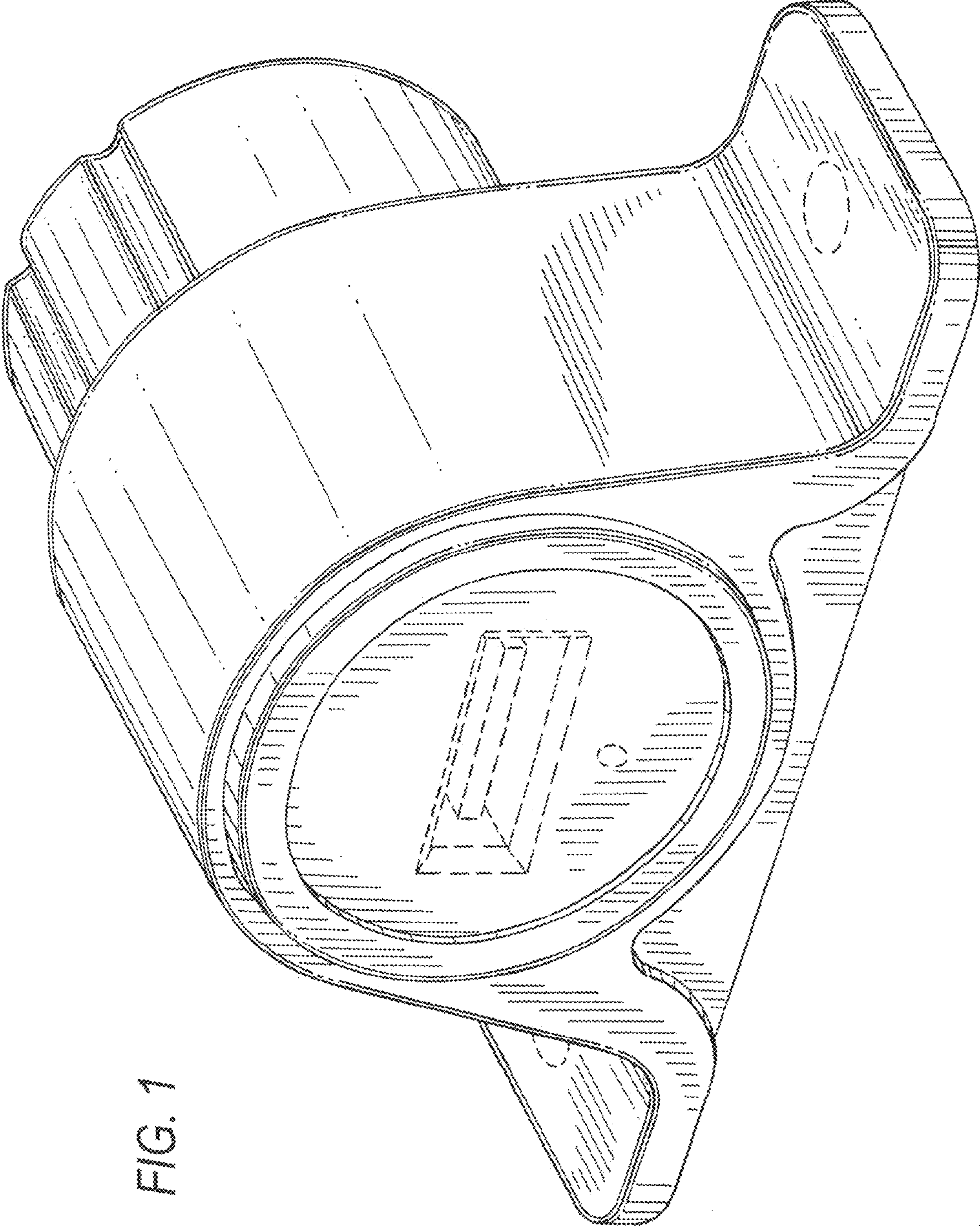

FIG. 1



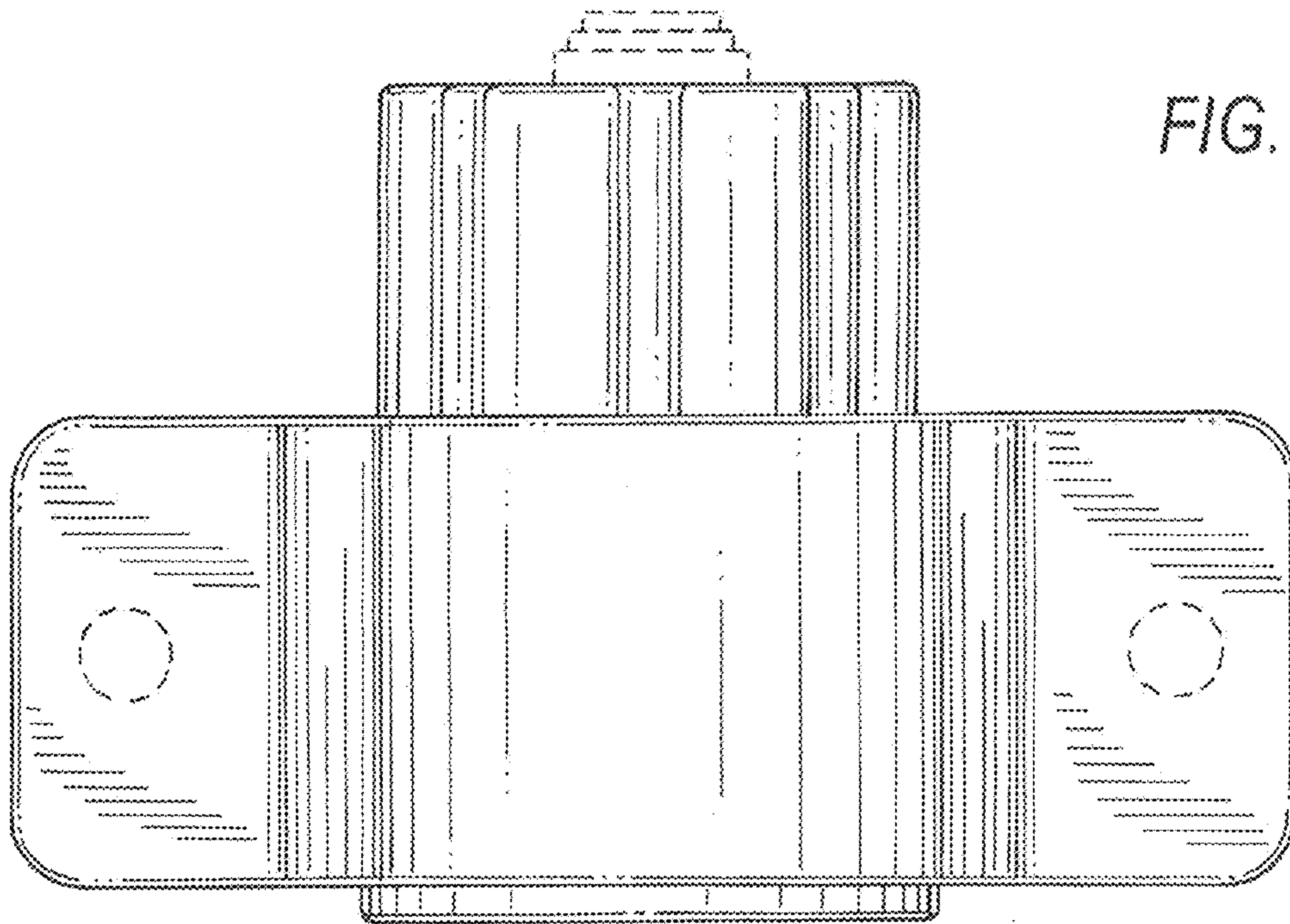

FIG. 2

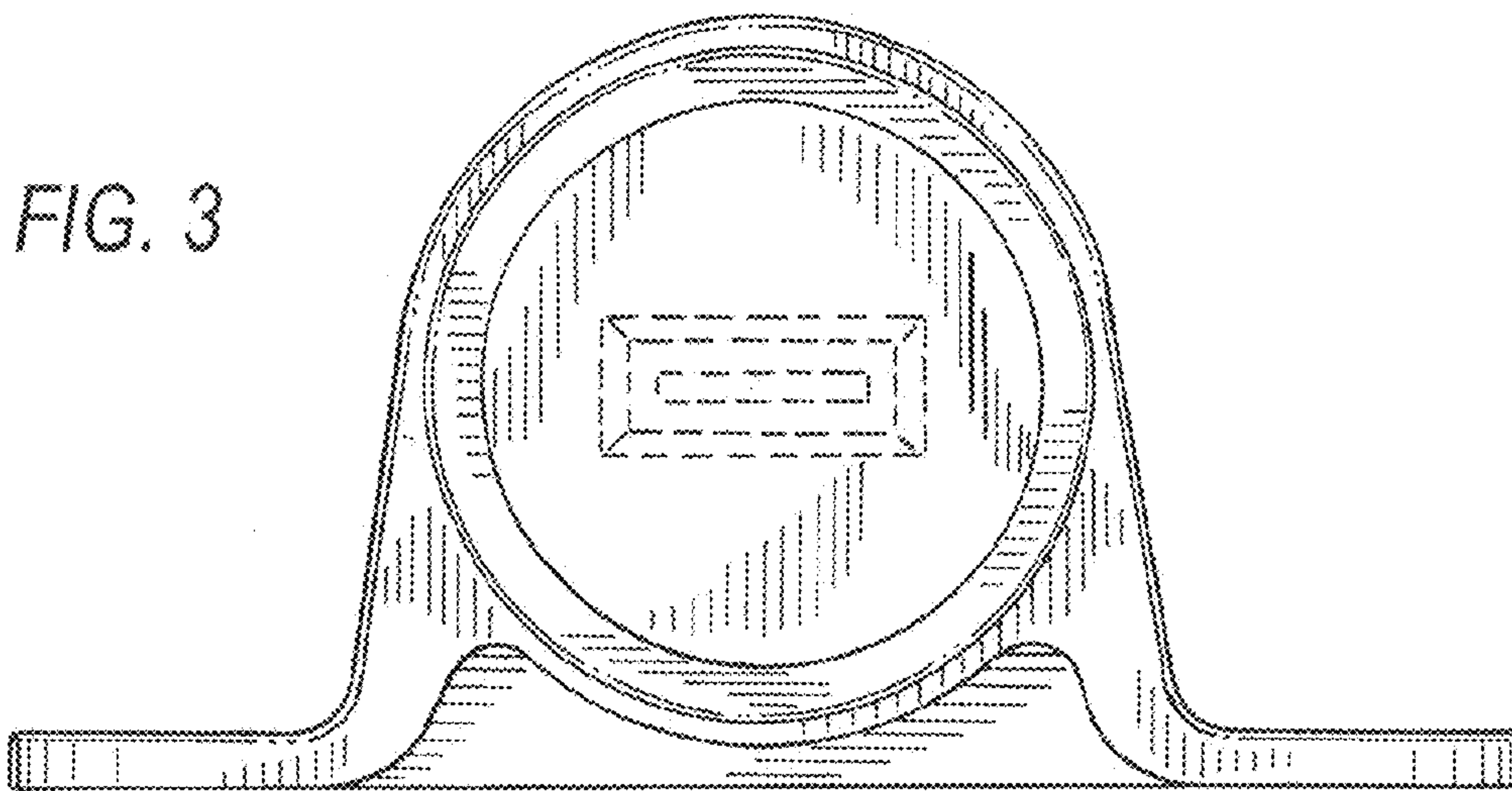

FIG. 3

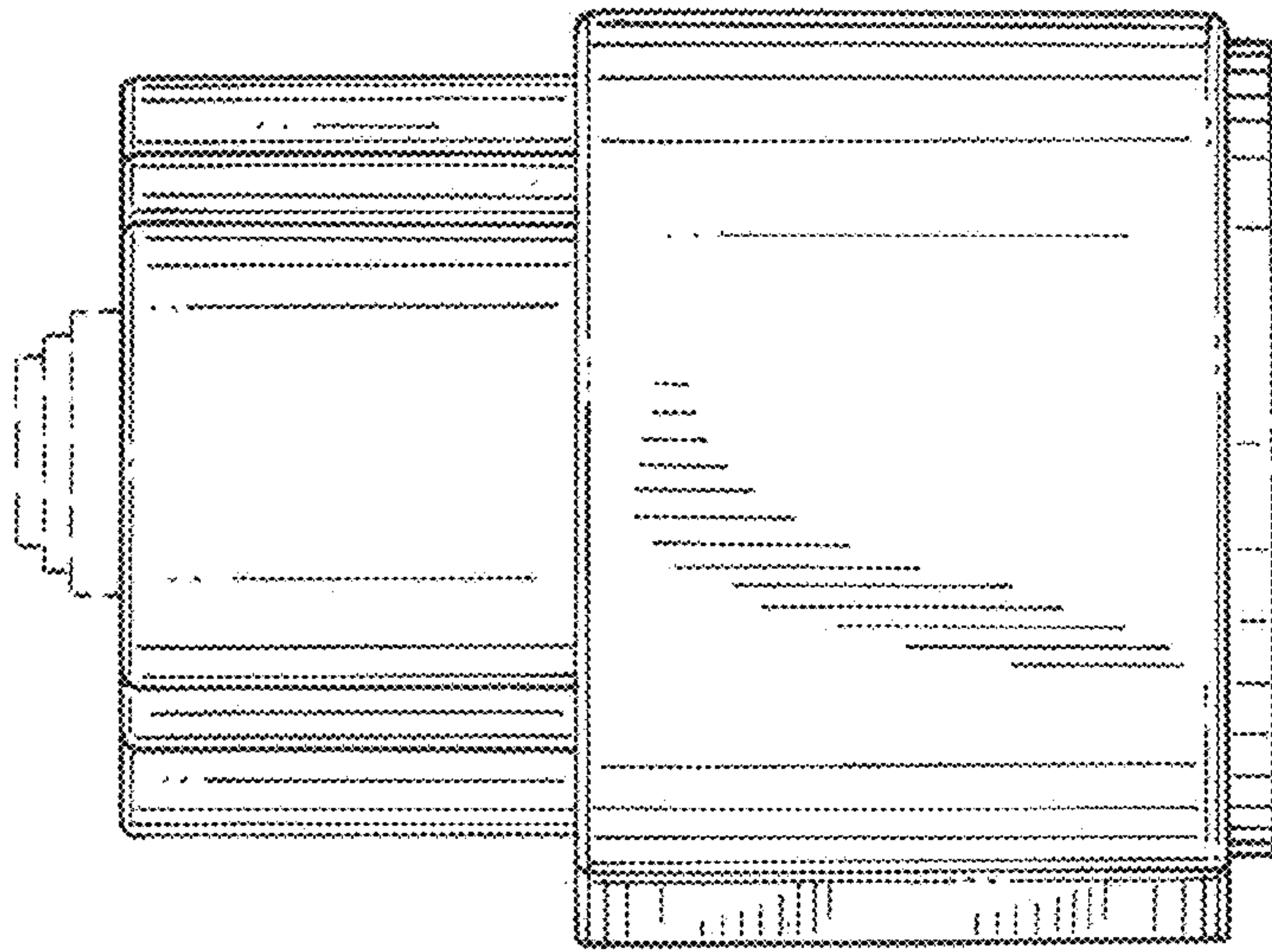

FIG. 4

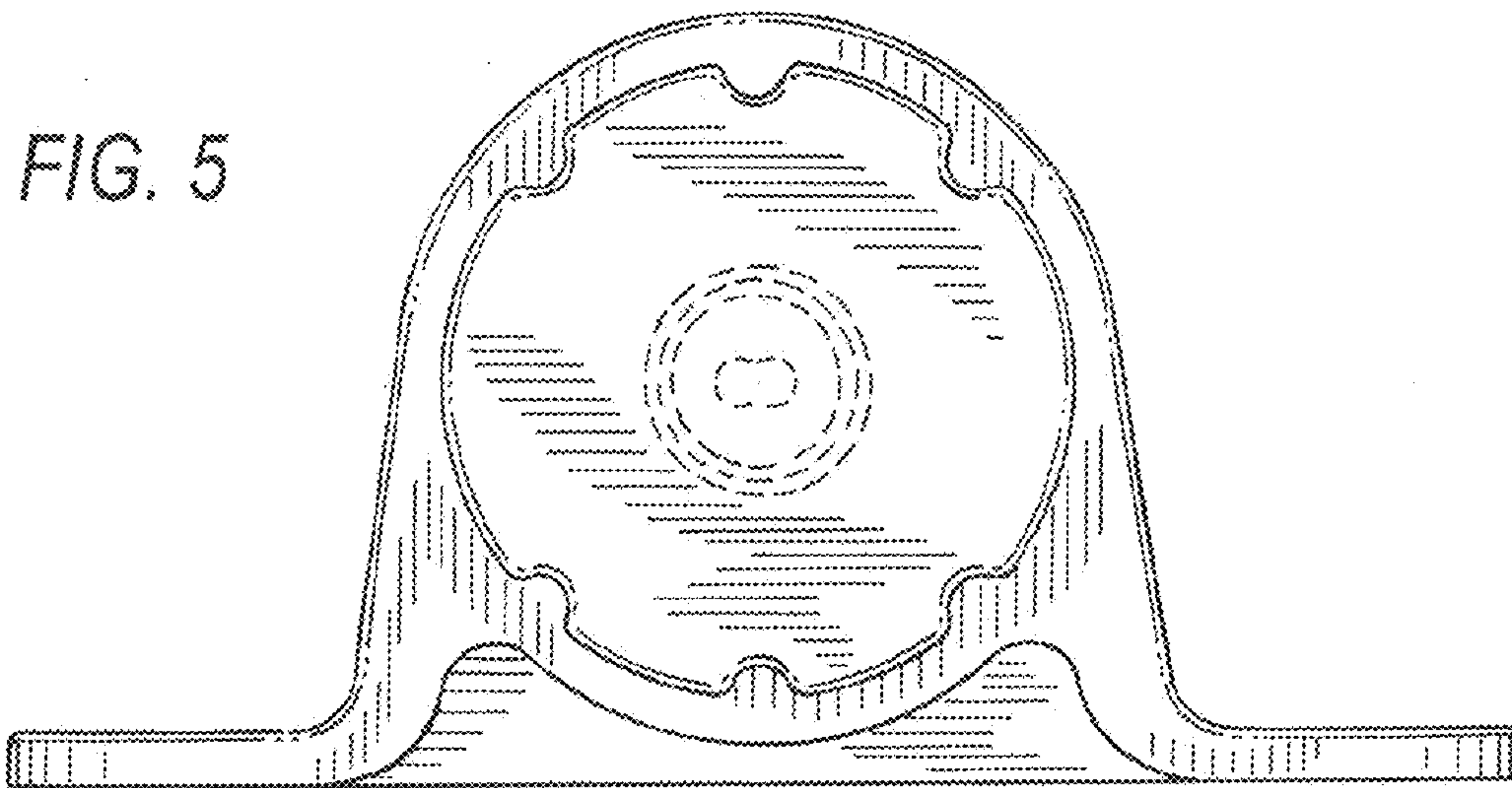

FIG. 5



FIG. 6

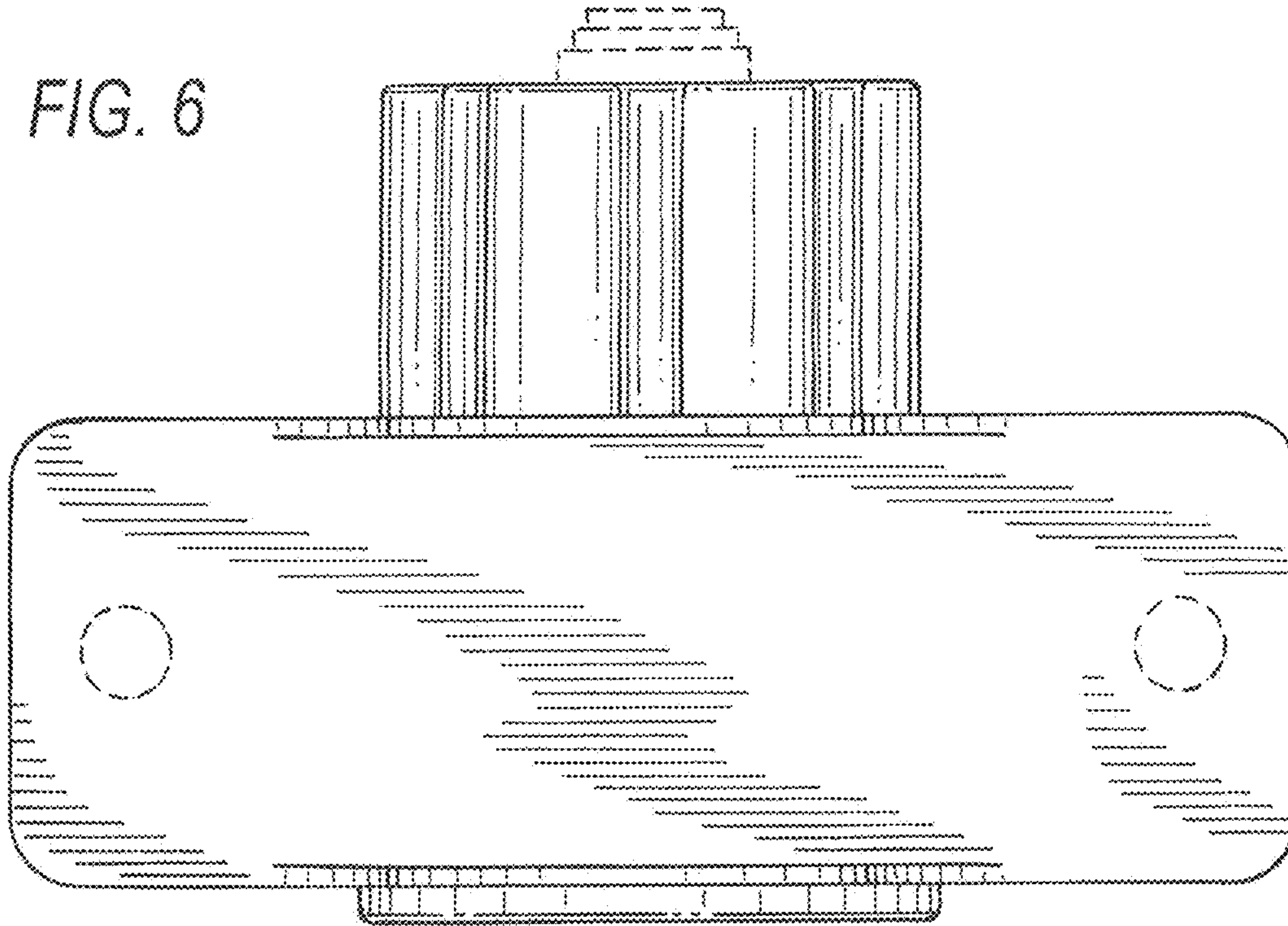

FIG. 7

